



Chipsmall Limited consists of a professional team with an average of over 10 year of expertise in the distribution of electronic components. Based in Hongkong, we have already established firm and mutual-benefit business relationships with customers from,Europe,America and south Asia,supplying obsolete and hard-to-find components to meet their specific needs.

With the principle of "Quality Parts,Customers Priority,Honest Operation,and Considerate Service",our business mainly focus on the distribution of electronic components. Line cards we deal with include Microchip,ALPS,ROHM,Xilinx,Pulse,ON,Everlight and Freescale. Main products comprise IC,Modules,Potentiometer,IC Socket,Relay,Connector.Our parts cover such applications as commercial,industrial, and automotives areas.

We are looking forward to setting up business relationship with you and hope to provide you with the best service and solution. Let us make a better world for our industry!



## Contact us

Tel: +86-755-8981 8866 Fax: +86-755-8427 6832

Email & Skype: info@chipsmall.com Web: www.chipsmall.com

Address: A1208, Overseas Decoration Building, #122 Zhenhua RD., Futian, Shenzhen, China



# PS088-315: 700-1100 MHz Voltage Controlled Phase Shifter

## Applications

- Amplifier linearization
- I/Q modulators/demodulators
- Vector modulators

## Features

- Wide operating range: 700 to 1100 MHz
- Phase shift range: 85 to 105 degrees
- Insertion loss variation: 1.5 dB
- Control voltage range: 0 to 12 V
- IP3: +33 dBm @ 900 MHz
- Small, MCM (8-pin, 4.9 x 3.2 mm) package (MSL3, 250 °C per JEDEC J-STD-020)



Skyworks Pb-free products are compliant with all applicable legislation. For additional information, refer to *Skyworks Definition of Lead (Pb)-Free*, document number SQ04-0073.

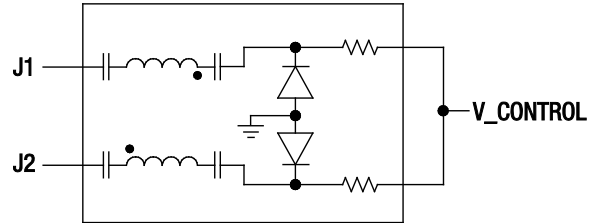

S2567

Figure 1. PS088-315 Block Diagram

## Description

The PS088-315 is a voltage controlled phase shifter. The device uses a monolithic quadrature hybrid and a pair of selected silicon varactor diodes to achieve a 100-degree phase shift and low insertion loss. The diodes are biased using an external control voltage signal. The phase shifter requires no external components and operates with a control voltage range of 0 to 12 V and a 1  $\mu$ A maximum control current.

The device has been designed to operate over the 700 to 1100 MHz frequency band, but is specifically optimized for use as a wide dynamic range, low distortion phase shifter, centered at 849 to 869 MHz.

A functional block diagram is shown in Figure 1. The pin configuration and package are shown in Figure 2. Signal pin assignments and functional pin descriptions are provided in Table 1.

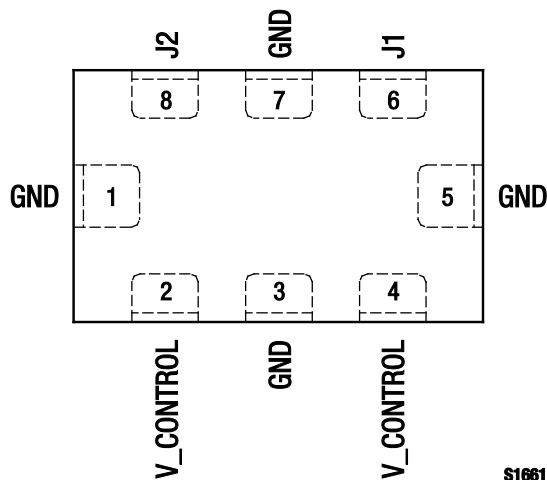

S1661

Figure 2. PS088-315 Pinout – 8-Pin MCM (Top View)

**Table 1. PS088-315 Signal Descriptions**

Pin #	Name	Description	Pin #	Name	Description
1	GND	Ground. Must be connected to PCB ground using lowest possible inductance path.	5	GND	Ground. Must be connected to PCB ground using lowest possible inductance path.
2	V_CONTROL	Control voltage input (voltage applied is nominally equal to the voltage applied to pin 4)	6	J1	RF input/output
3	GND	Ground. Must be connected to PCB ground using lowest possible inductance path.	7	GND	Ground. Must be connected to PCB ground using lowest possible inductance path.
4	V_CONTROL	Control voltage input (voltage applied is nominally equal to the voltage applied to pin 2)	8	J2	RF output/input

**Table 2. PS088-315 Absolute Maximum Ratings**

Parameter	Symbol	Minimum	Maximum	Units
RF input power	P <sub>IN</sub>		+20	dBm
Control voltage	V <sub>CONTROL</sub>		15	V
Storage temperature	T <sub>STG</sub>	-65	+150	°C
Operating temperature	T <sub>OP</sub>	-40	+85	°C

**Note:** Exposure to maximum rating conditions for extended periods may reduce device reliability. There is no damage to device with only one parameter set at the limit and all other parameters set at or below their nominal value. Exceeding any of the limits listed here may result in permanent damage to the device.

---

**CAUTION:** Although this device is designed to be as robust as possible, Electrostatic Discharge (ESD) can damage this device. This device must be protected at all times from ESD. Static charges may easily produce potentials of several kilovolts on the human body or equipment, which can discharge without detection. Industry-standard ESD precautions should be used at all times. The PS088-315 Phase Shifter is a Class 1B Human Body Model (HBM) ESD device.

---

**Electrical and Mechanical Specifications**

The absolute maximum ratings of the PS088-315 are provided in Table 2. Electrical specifications are provided in Table 3.

Performance characteristics for the PS088-315 are illustrated in Figures 3 through 8.

**Table 3. PS088-315 Electrical Specifications (Note 1)**  
**(Characteristic Impedance [Z<sub>0</sub>] = 50 Ω, Unless Otherwise Noted)**

Parameter	Symbol	Test Condition	Min	Typical	Max	Units
Phase shift		V <sub>CONTROL</sub> = 12 V from V <sub>CONTROL</sub> = 0 V, f = 849 to 869 MHz	85	100		deg
Control voltage range	V <sub>CONTROL</sub>		0		12	V
Control current	I <sub>CONTROL</sub>	V <sub>CONTROL</sub> = 12 V			1	μA
Insertion loss in bandwidth	IL	V <sub>CONTROL</sub> = 0 to 12 V, 849 to 869 MHz			2.8	dB
Insertion loss deviation in bandwidth	IL <sub>DEVIATION</sub>	V <sub>CONTROL</sub> = 0 to 12 V, 849 to 869 MHz			1.8	dB
Return loss in bandwidth	RL	V <sub>CONTROL</sub> = 0 to 12 V, 849 to 869 MHz	10			dB
3 <sup>rd</sup> Order Intermodulation	IM3	P <sub>IN</sub> = +8 dBm, V <sub>CONTROL</sub> = 0 V, @ 900 MHz and 905 MHz			-50	dBc
3 <sup>rd</sup> Order Intercept Point	IP3	Derived from IM3	+33			dBm

**Note 1:** Performance is guaranteed only under the conditions listed in this Table.

**Typical Performance Characteristics**  
**(Characteristic Impedance [Z<sub>0</sub>] = 50 Ω, Unless Otherwise Noted)**

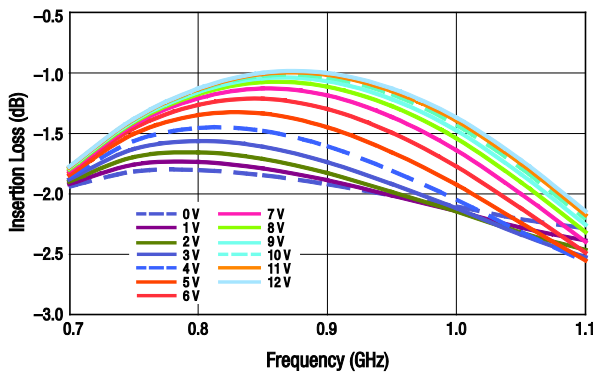

**Figure 3. Insertion Loss vs Frequency Over Control Voltage**

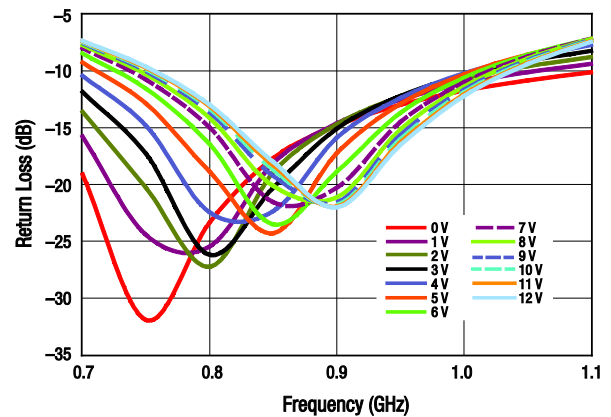

**Figure 4. Input Return Loss vs Frequency Over Control Voltage**

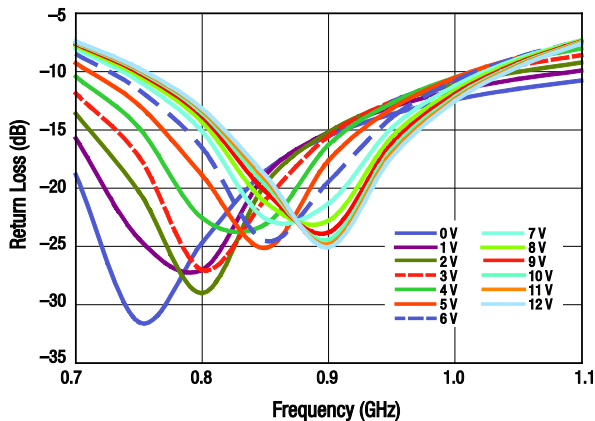

Figure 5. Output Return Loss vs Frequency Over Control Voltage

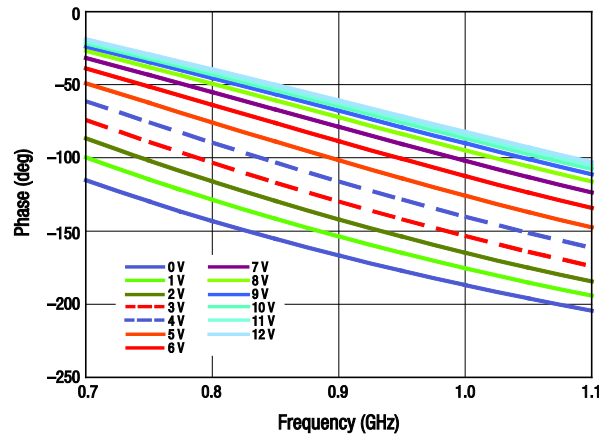

Figure 6. Insertion Phase vs Frequency Over Control Voltage

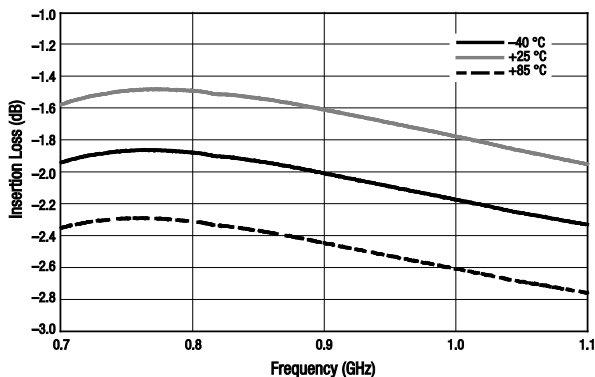

Figure 7. Insertion Loss vs Frequency Over Temperature (V\_CONTROL = 0 V)

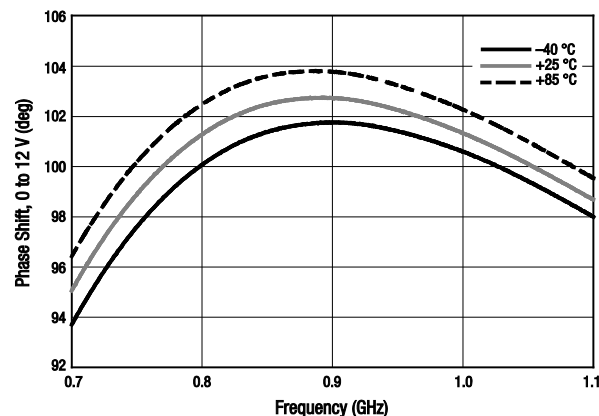

Figure 8. Phase Shift Delta vs Frequency Over Temperature

### Evaluation Board Description

The PS088-315 Evaluation Board is used to test the performance of the PS088-315 voltage controlled phase shifter. An assembly drawing for the Evaluation Board is shown in Figure 9. The Evaluation Board layer detail characteristics are shown in Figure 10.

The phase shift level of the PS088-315 is controlled by applying 0 to 12 V to the V\_CONTROL pin.

### Package Dimensions

The PCB layout footprint for the PS088-315 is shown in Figure 11. Typical case markings are shown in Figure 12. Package dimensions for the 8-pin MCM are shown in Figure 13, and tape and reel dimensions are provided in Figure 14.

### Package and Handling Information

Instructions on the shipping container label regarding exposure to moisture after the container seal is broken must be followed. Otherwise, problems related to moisture absorption may occur when the part is subjected to high temperature during solder assembly.

THE PS088-315 is rated to Moisture Sensitivity Level 3 (MSL3) at 250 °C. It can be used for lead or lead-free soldering. For additional information, refer to the Skyworks Application Note, *PCB Design & SMT Assembly/Rework Guidelines for MCM-L Packages*, document number 101752.

Care must be taken when attaching this product, whether it is done manually or in a production solder reflow environment. Production quantities of this product are shipped in a standard tape and reel format.

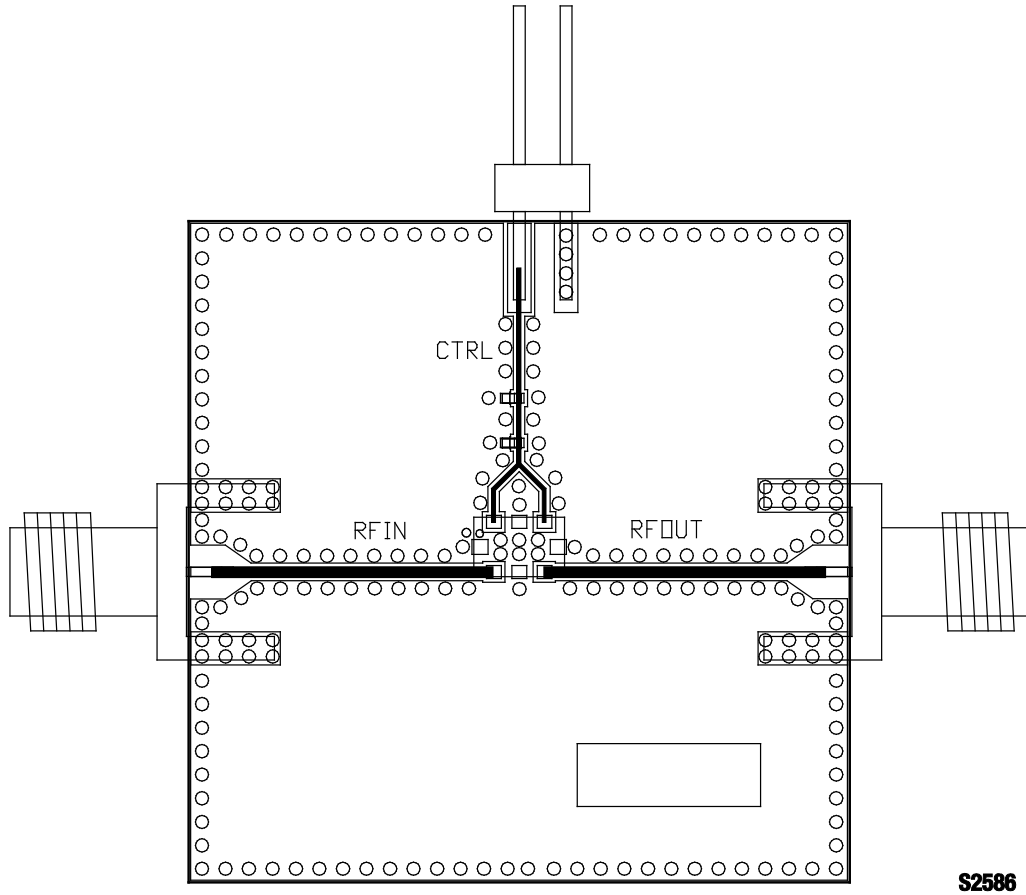
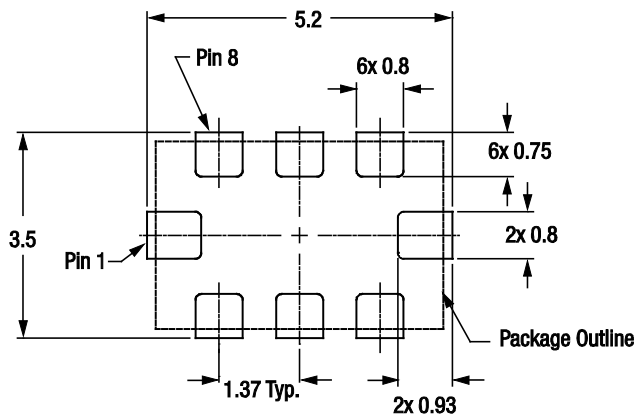

Figure 9. PS088-315 Evaluation Board Assembly Diagram

	Cross Section	Name	Thickness (in)	Material
$0.062 \pm 0.005$ in		Top Soldermask	-	-
		Top	(0.007)	Cu foil
		Dielectric	$0.012 \pm 0.0006$	Rogers R04003 Core
		L2	(0.007)	Cu foil
		Dielectric	FR4 Prepreg (Note 1)	-
		Bottom	(0.007)	Cu foil
		Bottom Soldermask	-	-

S2587

Figure 10. Layer Detail Physical Characteristics



Stencil Aperture  
Top View

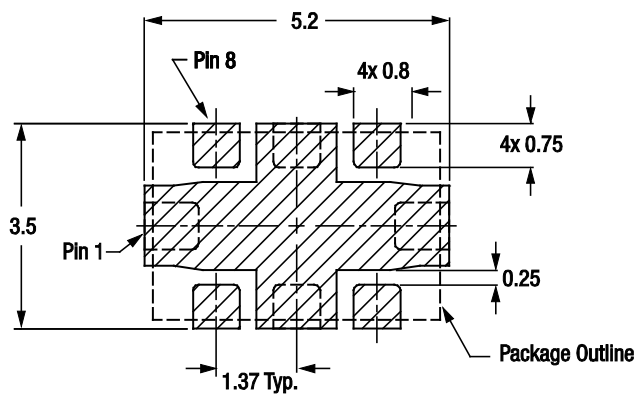

Metallization  
Top View

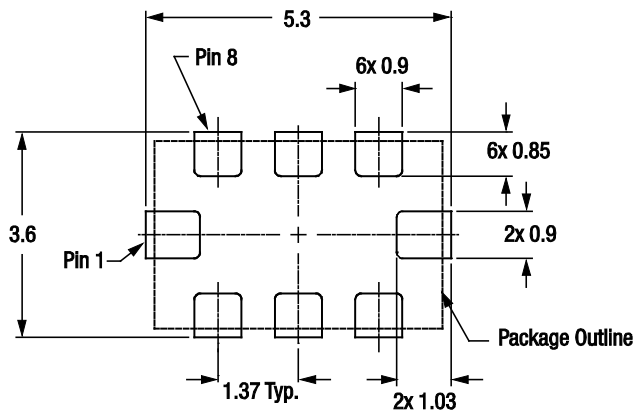

Solder Mask Opening  
Top View

All measurements in millimeters

S1667

Figure 11. PS088-315 PCB Layout Footprint

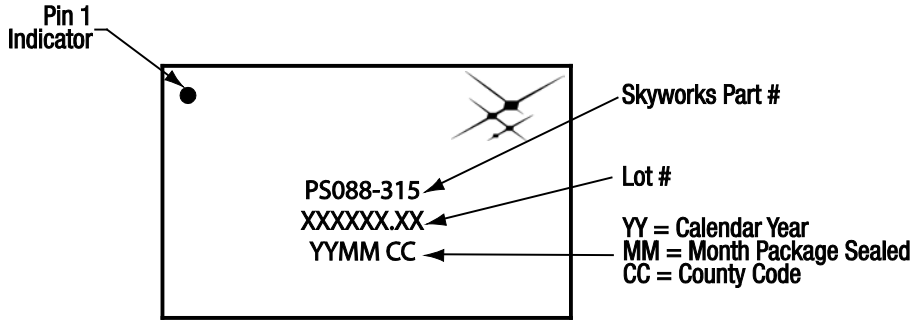

**Figure 12. Typical Part Markings (Top View)**

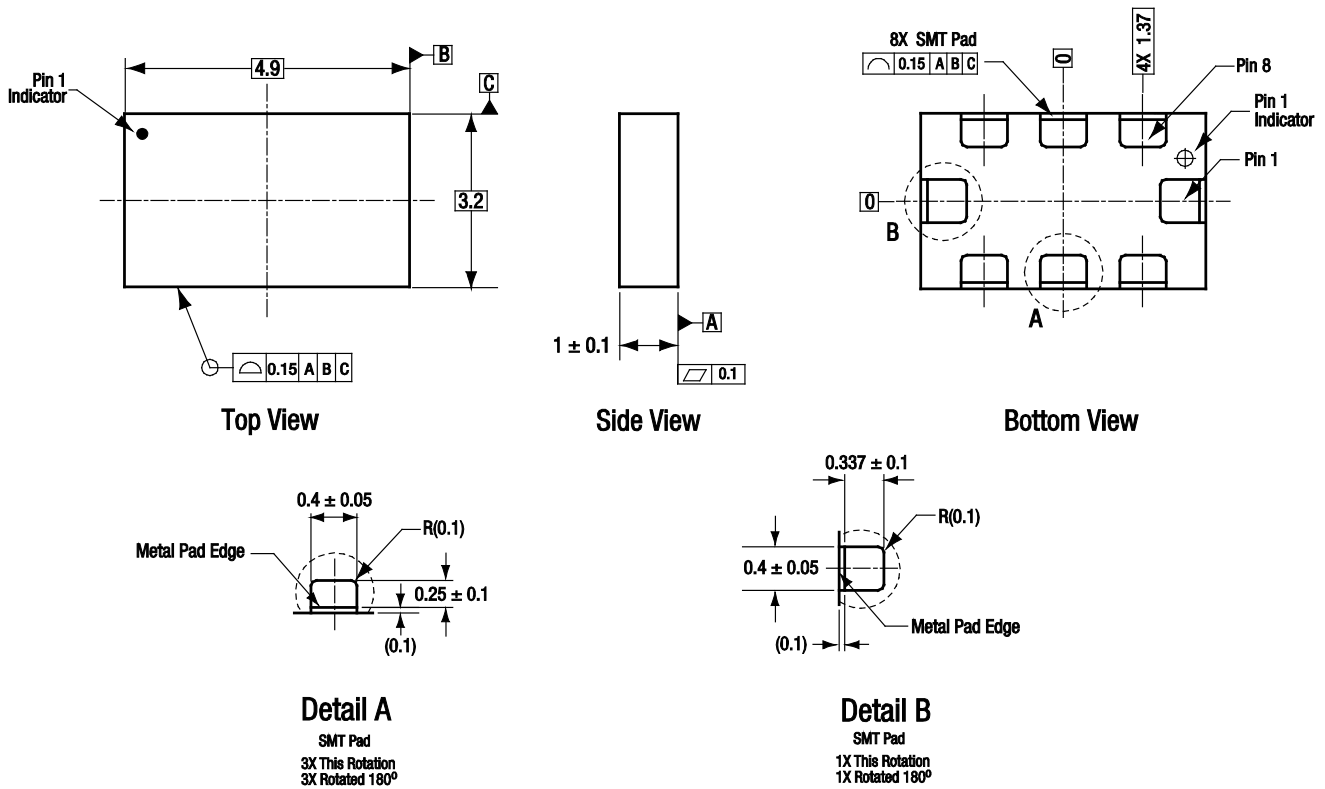

All measurements are in millimeters.

Dimensioning and tolerancing according to ASME Y14.5M-1994.

S1554

**Figure 13. PS088-315 8-Pin MCM Package Dimensions**



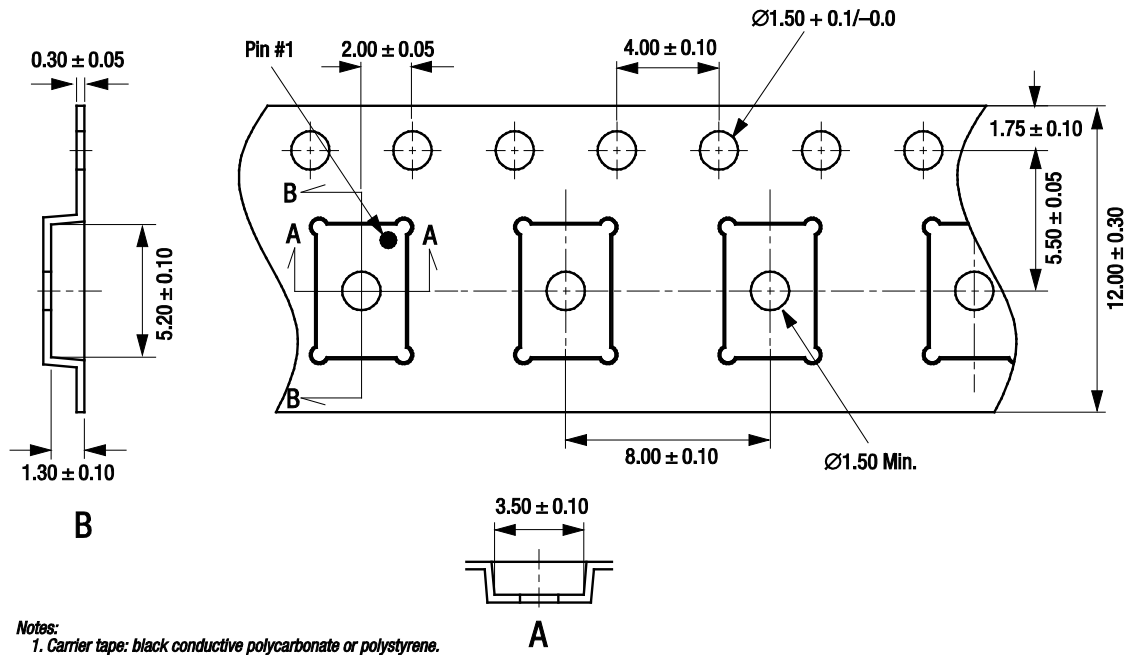

- Notes:
1. Carrier tape: black conductive polycarbonate or polystyrene.
  2. Cover tape material: transparent conductive PSA.
  3. Cover tape size: 9.30 mm width.
  4. Sprocket hole (10) pitch cumulative tolerance: ±0.20 mm.
  5. All measurements are in millimeters.

S1680

Figure 14. PS088-315 Tape and Reel Dimensions

**Ordering Information**

Model Name	Manufacturing Part Number	Evaluation Board Part Number
PS088-315 Voltage Controlled Phase Shifter	PS088-315	PS088-315-EVB

Copyright © 2002-2006, 2011 Skyworks Solutions, Inc. All Rights Reserved.

Information in this document is provided in connection with Skyworks Solutions, Inc. ("Skyworks") products or services. These materials, including the information contained herein, are provided by Skyworks as a service to its customers and may be used for informational purposes only by the customer. Skyworks assumes no responsibility for errors or omissions in these materials or the information contained herein. Skyworks may change its documentation, products, services, specifications or product descriptions at any time, without notice. Skyworks makes no commitment to update the materials or information and shall have no responsibility whatsoever for conflicts, incompatibilities, or other difficulties arising from any future changes.

No license, whether express, implied, by estoppel or otherwise, is granted to any intellectual property rights by this document. Skyworks assumes no liability for any materials, products or information provided hereunder, including the sale, distribution, reproduction or use of Skyworks products, information or materials, except as may be provided in Skyworks Terms and Conditions of Sale.

THE MATERIALS, PRODUCTS AND INFORMATION ARE PROVIDED "AS IS" WITHOUT WARRANTY OF ANY KIND, WHETHER EXPRESS, IMPLIED, STATUTORY, OR OTHERWISE, INCLUDING FITNESS FOR A PARTICULAR PURPOSE OR USE, MERCHANTABILITY, PERFORMANCE, QUALITY OR NON-INFRINGEMENT OF ANY INTELLECTUAL PROPERTY RIGHT; ALL SUCH WARRANTIES ARE HEREBY EXPRESSLY DISCLAIMED. SKYWORKS DOES NOT WARRANT THE ACCURACY OR COMPLETENESS OF THE INFORMATION, TEXT, GRAPHICS OR OTHER ITEMS CONTAINED WITHIN THESE MATERIALS. SKYWORKS SHALL NOT BE LIABLE FOR ANY DAMAGES, INCLUDING BUT NOT LIMITED TO ANY SPECIAL, INDIRECT, INCIDENTAL, STATUTORY, OR CONSEQUENTIAL DAMAGES, INCLUDING WITHOUT LIMITATION, LOST REVENUES OR LOST PROFITS THAT MAY RESULT FROM THE USE OF THE MATERIALS OR INFORMATION, WHETHER OR NOT THE RECIPIENT OF MATERIALS HAS BEEN ADVISED OF THE POSSIBILITY OF SUCH DAMAGE.

Skyworks products are not intended for use in medical, lifesaving or life-sustaining applications, or other equipment in which the failure of the Skyworks products could lead to personal injury, death, physical or environmental damage. Skyworks customers using or selling Skyworks products for use in such applications do so at their own risk and agree to fully indemnify Skyworks for any damages resulting from such improper use or sale.

Customers are responsible for their products and applications using Skyworks products, which may deviate from published specifications as a result of design defects, errors, or operation of products outside of published parameters or design specifications. Customers should include design and operating safeguards to minimize these and other risks. Skyworks assumes no liability for applications assistance, customer product design, or damage to any equipment resulting from the use of Skyworks products outside of stated published specifications or parameters.

Skyworks, the Skyworks symbol, and "Breakthrough Simplicity" are trademarks or registered trademarks of Skyworks Solutions, Inc., in the United States and other countries. Third-party brands and names are for identification purposes only, and are the property of their respective owners. Additional information, including relevant terms and conditions, posted at [www.skyworksinc.com](http://www.skyworksinc.com), are incorporated by reference.