



Chipsmall Limited consists of a professional team with an average of over 10 year of expertise in the distribution of electronic components. Based in Hongkong, we have already established firm and mutual-benefit business relationships with customers from,Europe,America and south Asia,supplying obsolete and hard-to-find components to meet their specific needs.

With the principle of "Quality Parts,Customers Priority,Honest Operation,and Considerate Service",our business mainly focus on the distribution of electronic components. Line cards we deal with include Microchip,ALPS,ROHM,Xilinx,Pulse,ON,Everlight and Freescale. Main products comprise IC,Modules,Potentiometer,IC Socket,Relay,Connector.Our parts cover such applications as commercial,industrial, and automotives areas.

We are looking forward to setting up business relationship with you and hope to provide you with the best service and solution. Let us make a better world for our industry!



## Contact us

Tel: +86-755-8981 8866 Fax: +86-755-8427 6832

Email & Skype: info@chipsmall.com Web: www.chipsmall.com

Address: A1208, Overseas Decoration Building, #122 Zhenhua RD., Futian, Shenzhen, China



### Intellimod™ Module Application Specific IPM 5 Amperes/1200 Volts

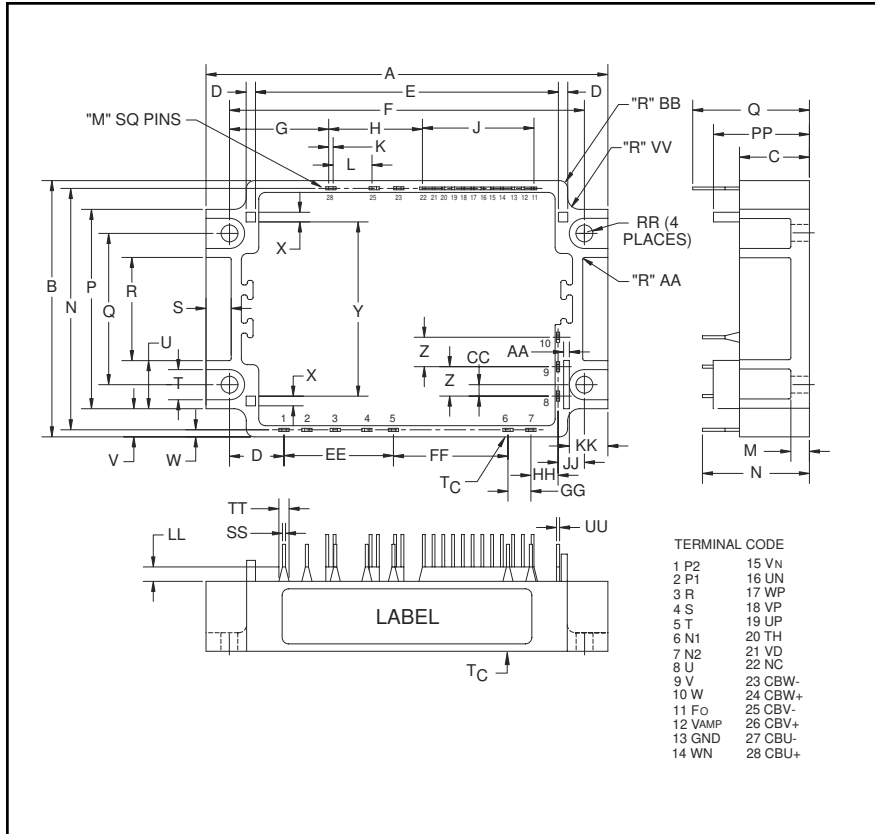

Outline Drawing and Circuit Diagram

Dimensions	Inches	Millimeters
A	4.06 +0/-0.02	103.0+0/-0.4
B	2.87 +0/-0.02	73.0 +0/-0.4
C	0.35	9.0
D	0.10	2.5
E	3.11	79.0
F	3.74±0.01	95±0.2
G	1.32	33.5
H	0.95	24.0
J	0.87	22.0
K	0.08	2.0
L	0.24	6.0
M	0.02 Sq.	0.5 Sq.
N	2.72	69.0
P	2.13	54.0
Q	1.54±0.01	39.0±0.2
R	0.95	24.0
S	0.26	6.5
T	0.35	9.0
U	0.59	15.0
V	0.37	9.5
W	0.08	2.0
X	0.12	3.0

Dimensions	Inches	Millimeters
Y	1.81	46.0
Z	0.30	7.62
AA	0.08 Rad.	2.0 Rad.
BB	0.04 Rad.	1.0 Rad.
CC	0.14	3.5
DD	0.47	12.0
EE	1.20	30.48
FF	0.90	22.86
GG	0.30	7.62
HH	0.51	13.4
JJ	0.35	9.0
KK	0.34	8.5
LL	0.08	2.0
MM	0.12	3.0
NN	0.67	17.0
PP	0.49	12.5
QQ	0.80	20.4
RR	0.16	4.0
SS	0.06	1.4
TT	0.12	3.0
UU	0.04	1.0
VV	0.16	4.0



#### Description:

Powerex Application Specific IPMs (ASIPMs) are intelligent power modules that integrate power devices, gate drive and protection circuitry in a compact package for use in small inverter applications up to 20kHz. Use of application specific HVICs allow the designer to reduce inverter size and overall design time.

#### Features:

- Rectifier Bridge for 3-phase AC-to-DC Power Conversion
- 3-phase IGBT Inverter Bridge
- Integrated HVICs for Gate Drive, Protection and System Control Functions
- Built-in Thermistor
- Direct Connection to DSP/CPU

#### Applications:

- Smart Motors
- General Purpose Inverters
- Small Motor Control

#### Ordering Information:

PS12032 is a 1200V, 5 Ampere Application Specific Power Module.

**PS12032**  
**Intellimod™ Module**  
**Application Specific IPM**  
 5 Amperes/1200 Volts

## Absolute Maximum Ratings, $T_j = 25^\circ\text{C}$ unless otherwise specified

Characteristics	Symbol	PS12032	Units
Power Device Junction Temperature*	$T_j$	-20 to 125	$^\circ\text{C}$
Storage Temperature	$T_{\text{stg}}$	-40 to 125	$^\circ\text{C}$
Case Operating Temperature (See $T_C$ Measure Point Illustration)	$T_C$	-20 to 100	$^\circ\text{C}$
Mounting Torque, M3.5 Mounting Screws	—	11.25	in-lb
Module Weight (Typical)	—	127	Grams
Isolation Voltage**	$V_{\text{ISO}}$	2500	Volts

\*The indicated values are specified considering the safe operation of all the parts within the ASIPM. The maximum rating for the ASIPM power chips (IGBT & FWDI) is  $T_j < 150$ .

\*\*60 Hz sinusoidal AC applied between all terminals and the base plate for 1 minute.

## IGBT Inverter Sector

Supply Voltage (Applied between P2 - N2)	$V_{\text{CC}}$	900	Volts
Supply Voltage, Surge (Applied between P2 - N2, Surge-Value)	$V_{\text{CC(surge)}}$	1000	Volts
Each IGBT Collector-Emitter Static Voltage (Applied between P2-U·V·W, U·V·W-N2)	$V_P$ or $V_N$	1200	Volts
Each IGBT Collector-Emitter Switching Voltage (Applied between P2-U·V·W, U·V·W-N2 (Pulse))	$V_{P(S)}$ or $V_{N(S)}$	1200	Volts
Each IGBT Collector Current, $T_C = 25^\circ\text{C}$ , "( )" means $I_C$ Peak Value	$\pm I_C$ ( $\pm I_{CP}$ )	$\pm 5$ ( $\pm 10$ )	Amperes

## Converter Sector

Repetitive Peak Reverse Voltage	$V_{\text{RRM}}$	1600	Volts
Recommended AC Input Voltage	$E_a$	440	Vrms
DC Output Current (3-phase Rectifying Circuit)	$I_O$	12	A
Surge (Non-repetitive) Forward Current (1 Cycle at 60Hz, Peak Value Non-repetitive)	$I_{\text{FSM}}$	120	A
$I^2t$ for Fusing (Value for One Cycle of Surge Current)	$I^2t$	60	$\text{A}^2\text{s}$

## Control Sector

Supply Voltage	$V_D, V_{\text{DB}}$	-0.5 ~ 20	Volts
Input Signal Voltage	$V_{\text{CIN}}$	-0.5 ~ 7.5	Volts
Fault Output Supply Voltage	$V_{\text{FO}}$	-0.5 ~ 7.5	Volts
Fault Output Current	$I_{\text{FO}}$	15	mA
DC-link IGBT Current Signal Amp Output Current	$I_{\text{AMP}}$	1	mA

**PS12032**  
**Intellimod™ Module**  
**Application Specific IPM**  
 5 Amperes/1200 Volts

## Electrical and Mechanical Characteristics, $T_j = 25^\circ\text{C}$ unless otherwise specified

Characteristics	Symbol	Test Conditions	Min.	Typ.	Max.	Units
<b>IGBT Inverter Sector</b>						
Collector-Emitter Saturation Voltage	$V_{CE(sat)}$	$I_C = 5\text{A}$ , $T_j = 25^\circ\text{C}$ , $V_D = V_{DB} = 15\text{V}$ , Input = ON (Shunt Voltage Drop Not Included)	—	—	3.6	Volts
Diode Forward Voltage	$V_{EC}$	$T_j = 25^\circ\text{C}$ , $-I_C = 5\text{A}$	—	—	3.5	Volts
Converter Diode Voltage	$V_{FR}$	$T_j = 25^\circ\text{C}$ , $I_{FR} = 5\text{A}$	—	—	1.5	Volts
Converter Diode Reverse Current	$I_{RRM}$	$V_R = V_{RRM}$ , $T_j = 125^\circ\text{C}$	—	—	8.0	mA
Switching Times	$t_{on}$	1/2 Bridge Inductive, Input = $5\text{V} \leftrightarrow 0\text{V}$ ,	0.3	1.2	2.0	$\mu\text{S}$
	$t_{C(on)}$	$V_{CC} = 600\text{V}$ , $I_C = 5\text{A}$ , $T_j = 125^\circ\text{C}$ ,	—	0.5	1.4	$\mu\text{S}$
	$t_{off}$	$V_D = 15\text{V}$ , $V_{DB} = 15\text{V}$	—	2.2	4.0	$\mu\text{S}$
	$t_{C(off)}$	Note: $t_{on}$ , $t_{off}$ include delay time of the internal control circuit.	—	0.9	1.6	$\mu\text{S}$
FWDi Reverse Recovery Time	$t_{rr}$		—	0.2	—	$\mu\text{S}$
Short-circuit Endurance (Output, Arm, and Load Short-circuit Modes)		@ $V_{CC} \leq 800\text{V}$ , Input = $5\text{V} \rightarrow 0\text{V}$ (One-shot), $-20^\circ\text{C} \leq T_{j(start)} \leq 125^\circ\text{C}$ , $13.5\text{V} \leq V_D = V_{DB} \leq 16.5\text{V}$				<ul style="list-style-type: none"> <li>• No Destruction</li> <li>• <math>F_O</math> Output by Protection Operation</li> </ul>
Switching SOA		@ $V_{CC} \leq 800\text{V}$ , Input = $5\text{V} \rightarrow 0\text{V}$ , $T_j \leq 150^\circ\text{C}$ , $I_C < \text{OC Trip Level}$ , $13.5\text{V} \leq V_D = V_{DB} \leq 16.5\text{V}$				<ul style="list-style-type: none"> <li>• No Destruction</li> <li>• No Protecting Operation</li> <li>• No <math>F_O</math> Output</li> </ul>

$T_C$  Measure Point

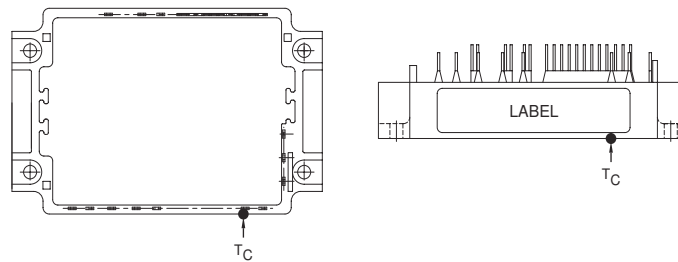

**PS12032**  
**Intellimod™ Module**  
**Application Specific IPM**  
 5 Amperes/1200 Volts

## Electrical and Mechanical Characteristics, $T_j = 25^\circ\text{C}$ unless otherwise specified

Characteristics	Symbol	Test Conditions	Min.	Typ.	Max.	Units
<b>Control Sector</b>						
Circuit Current (Average)	$I_D$	$T_j = 25^\circ\text{C}, V_D = 15\text{V}, V_{IN} = 5\text{V}$	—	—	50	mA
	$I_{DB}$	$T_j = 25^\circ\text{C}, V_D = V_{DB} = 15\text{V}, V_{IN} = 5\text{V}$	—	—	5	mA
Input ON Threshold Voltage	$V_{th(on)}$		0.8	1.4	2.0	Volts
Input OFF Threshold Voltage	$V_{th(off)}$		2.5	3.0	4.0	Volts
Input Pull-up Resistor	$R_i$	Applied between Input Terminal-inside Power Supply	—	50	—	$k\Omega$
PWM Input Frequency	$f_{PWM}$	$T_C \leq 100^\circ\text{C}, T_j \leq 125^\circ\text{C}$	—	10	15	kHz
Arm Shoot-through Blocking Time*	$t_{DEAD}$	Relates to Corresponding Inputs $T_C = -20^\circ\text{C} \sim 100^\circ\text{C}$	4.0	—	—	$\mu\text{s}$
Input Interlock Sensing	$t_{int}$	Relates to Corresponding Input	—	100	—	ns
Inverter DC-link IGBT Current	$V_{amp} 100\%$	$I_C = I_{OP(100\%)}, V_D = 15\text{V}, T_j = 25^\circ\text{C}$	1.5	2.0	2.5	Volts
Sense Voltage Output Signal**	$V_{amp} 200\%$	$I_C = I_{OP(200\%)}, V_D = 15\text{V}, T_j = 25^\circ\text{C}$	3.0	4.0	5.0	Volts
Inverter DC-link IGBT Current	$V_{amp} 250\%$	$I_C = I_{OP(250\%)}, V_D = 15\text{V}$	5.0	—	—	Volts
Sense Voltage Output Limit**	$V_{amp} 0\%$	$I_C = I_{OP(0\%)}, V_D = 15\text{V}$	—	50	100	mV
Over-current Trip Level	OC		5.5	7.0	—	Amperes
Over-current Delay Time	$t_{OC}$	$T_j = 25^\circ\text{C}$	—	10	—	$\mu\text{s}$
Short-circuit Trip Level	SC		—	11.0	—	Amperes
Short-circuit Delay Time	$t_{SC}$		—	2	—	$\mu\text{s}$
Supply Circuit	Trip Level	$UV_D$	11.0	12.0	12.75	Volts
	Reset Level	$UV_{Dr}$	11.5	12.5	13.25	Volts
Under-voltage	Trip Level	$UV_{DB}$	10.1	10.8	11.6	Volts
Protection	Reset Level	$UV_{DBr}$	10.6	11.3	12.1	Volts
	Delay Time	$t_{dV}$	—	10	—	$\mu\text{s}$
Fault Output Pulse Width***	$t_{FO}$	$T_j = 25^\circ\text{C}$	1.0	1.8	—	mS
Fault Output Current***	$I_{FO(H)}$	Open Collector Output	—	—	1	$\mu\text{A}$
	$I_{FO(L)}$		—	—	15	mA
Thermistor Resistance	$R_{TO}$	$T_O = 25^\circ\text{C} (298\text{K})$	9.5	10	10.5	$k\Omega$
Material Constant****	$\beta$	$T_1 = 25^\circ\text{C}, T_2 = 50^\circ\text{C}$	—	3450	—	K

\* The dead-time has to be set externally by the CPU; it is not part of the ASIPM internal functions.

\*\*Refer to the graph on next page.

\*\*\*Fault output signalling is given only when the internal OC, SC, and UV protection circuits are activated. The OC, SC and UV protection (and fault output) operate for the lower arms only. The OC and SC protection fault output is given in a pulse format while that of UV protection is maintained throughout the duration of the under-voltage condition.

$$****T = \frac{1}{\frac{1}{\beta} \cdot \ln \left[ \frac{R_T}{R_{TO}} \right] + \frac{1}{T_O}}$$

**PS12032**  
**Intellimod™ Module**  
**Application Specific IPM**  
 5 Amperes/1200 Volts

## Thermal Characteristics

Characteristic	Symbol	Condition	Min.	Typ.	Max.	Units
Junction to Case	$R_{th(j-c)Q}$	Each IGBT	—	—	2.5	°C/Watt
	$R_{th(j-c)D}$	Each FWDi	—	—	4.5	°C/Watt
	$R_{th(j-c)FR}$	Each Converter	—	—	2.5	°C/Watt
Contact Thermal Resistance	$R_{th(c-f)}$	Case to Fin Per Module. Thermal Grease Applied	—	—	0.05	°C/Watt

## Recommended Conditions for Use

Characteristic	Symbol	Condition	Min.	Typ.	Value	Units
Supply Voltage	$V_{CC}$	Applied across P2-N2 Terminals	—	600	800	Volts
Control Supply Voltage	$V_D$	Applied between $V_D$ -GND	13.5	15.0	16.5	Volts
	$V_{DB}$	Applied between CBU+ & CBU-, CBV+ & CBV-, CBW+ & CBW-	13.5	15.0	16.5	Volts
Control Supply dv/dt	$dV_D/dt, dV_{DB}/dt$		-1	—	1	V/ $\mu$ s
Input ON Voltage	$V_{CIN(on)}$	Applied between	0	—	0.8	Volts
Input OFF Voltage	$V_{CIN(off)}$	$U_P, V_P, W_P, U_N, V_N, W_N$ -GND	4.0	—	5.0	Volts
Module Case Operating Temperature	$T_C$		—	—	100	°C
PWM Input Frequency	$f_{PWM}$	$T_C \leq 100^\circ\text{C}, T_J \leq 125^\circ\text{C}$	—	—	15	kHz
Allowable Minimum Input On-pulse Width	$t_{XX}$		1	—	—	$\mu$ s
Arm Shoot-through Blocking Time	$t_{DEAD}$	Relate to Corresponding Inputs	4.0	—	—	$\mu$ s

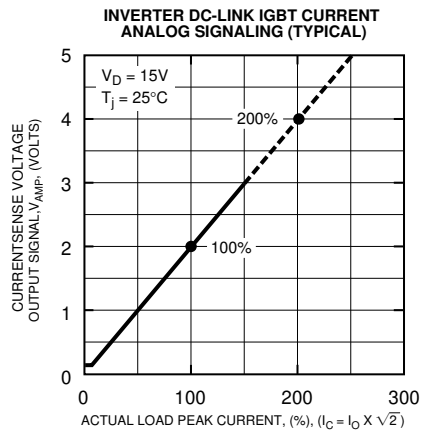

**PS12032**  
**Intellimod™ Module**  
**Application Specific IPM**  
 5 Amperes/1200 Volts

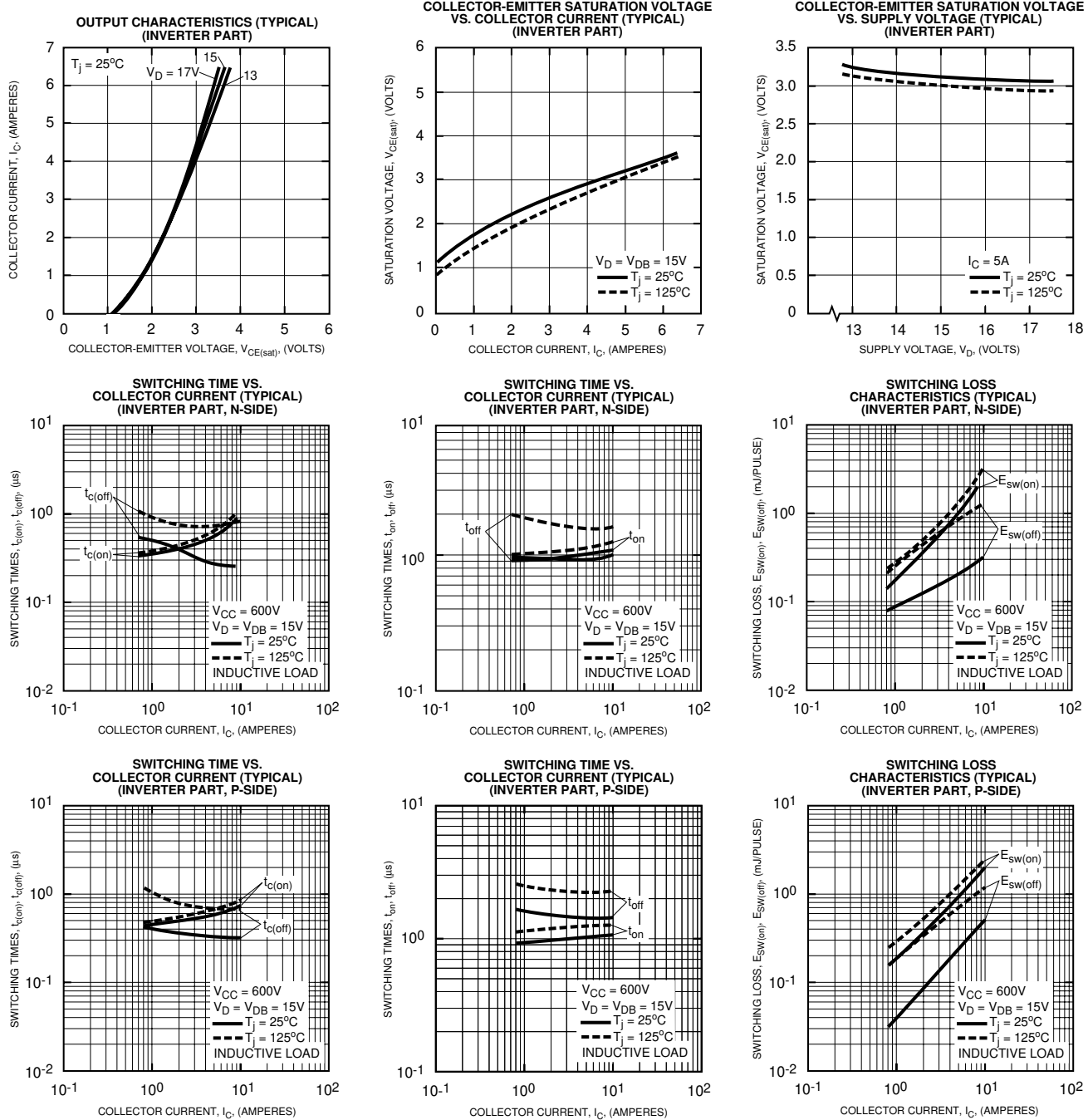

**PS12032**  
**Intellimod™ Module**  
**Application Specific IPM**  
 5 Amperes/1200 Volts

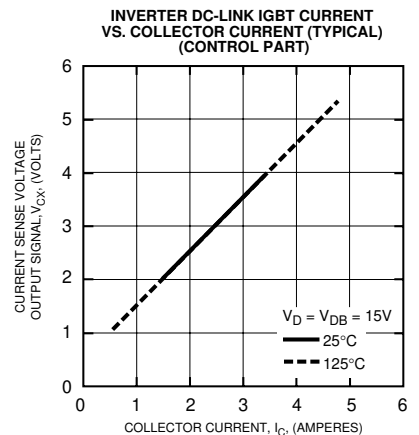
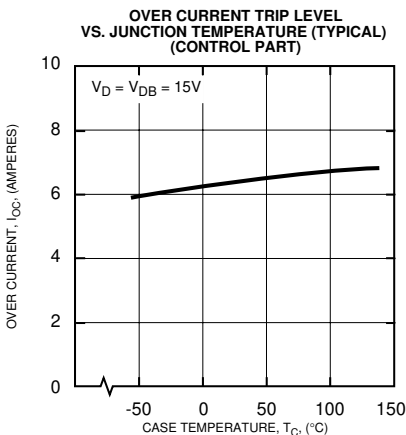
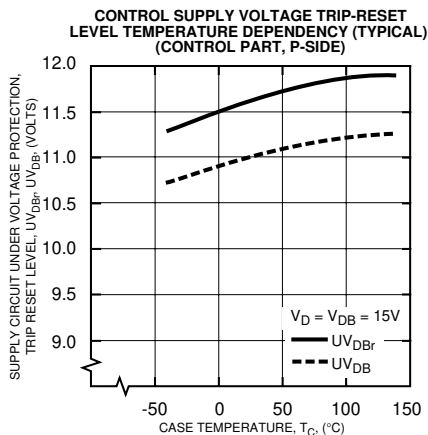
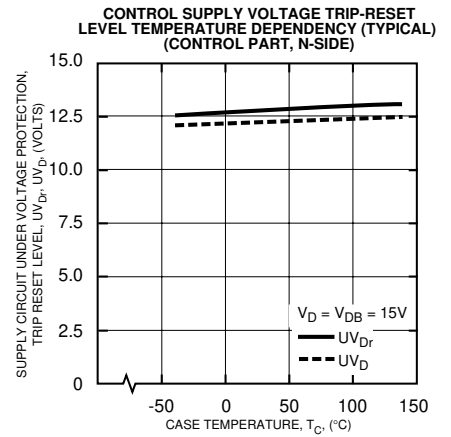
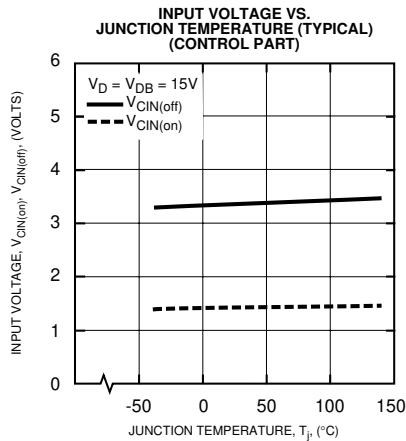
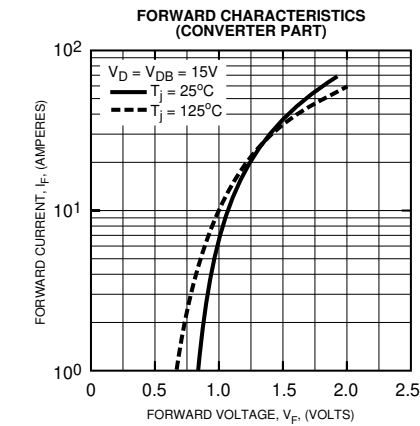
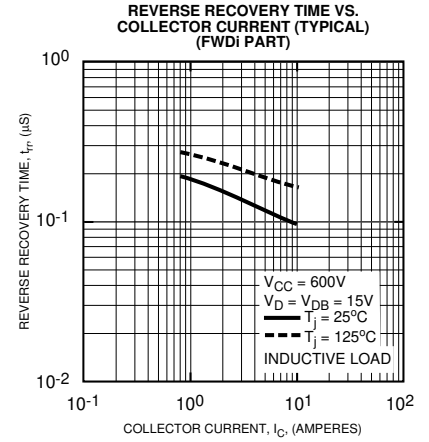
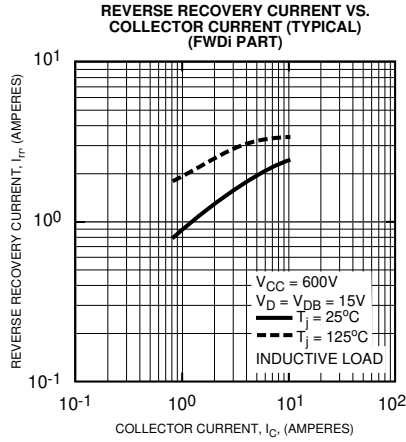
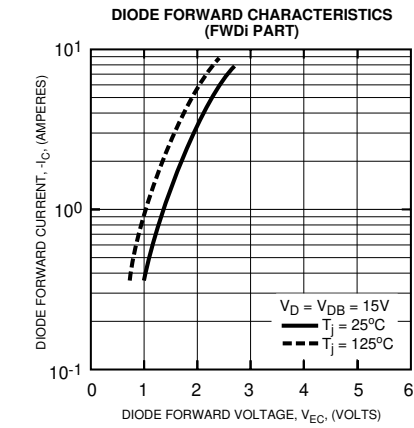



**PS12032**  
**Intellimod™ Module**  
**Application Specific IPM**  
 5 Amperes/1200 Volts

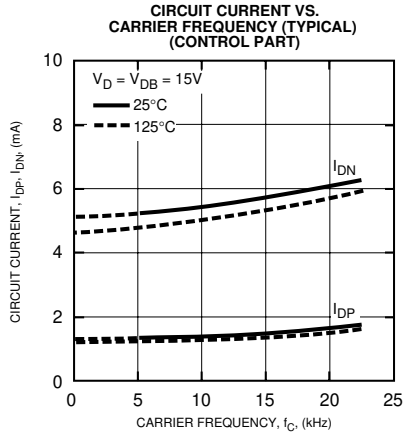

Functional Block Diagram

