



Chipsmall Limited consists of a professional team with an average of over 10 year of expertise in the distribution of electronic components. Based in Hongkong, we have already established firm and mutual-benefit business relationships with customers from,Europe,America and south Asia,supplying obsolete and hard-to-find components to meet their specific needs.

With the principle of “Quality Parts,Customers Priority,Honest Operation,and Considerate Service”,our business mainly focus on the distribution of electronic components. Line cards we deal with include Microchip,ALPS,ROHM,Xilinx,Pulse,ON,Everlight and Freescale. Main products comprise IC,Modules,Potentiometer,IC Socket,Relay,Connector.Our parts cover such applications as commercial,industrial, and automotives areas.

We are looking forward to setting up business relationship with you and hope to provide you with the best service and solution. Let us make a better world for our industry!



## Contact us

Tel: +86-755-8981 8866 Fax: +86-755-8427 6832

Email & Skype: info@chipsmall.com Web: www.chipsmall.com

Address: A1208, Overseas Decoration Building, #122 Zhenhua RD., Futian, Shenzhen, China



## MODEL PSC - PROCESS SETPOINT CONTROLLER



- SETPOINT PROGRAM CONTROLLER FOR TIME VS. PROCESS (RAMP/SOAK) AND SPECIAL BATCH/RECIPE APPLICATIONS
- ADVANCED PROGRAM PROFILING IN A 1/8 DIN PACKAGE
- ON-LINE MONITORING AND CONTROL OF PROGRAM STATUS, TIME, AND SETPOINT VALUE (Profile Run, Pause, Stop, Advance, Modify Time, & Setpoint Value)

- AUTOMATIC PROGRAM DELAY FOR PROFILE CONFORMITY, PLUS PROGRAM LINKING, REPEATING AND AUTO POWER-ON FUNCTIONS FOR ENHANCED CAPABILITY
- DUAL EVENT OUTPUTS FOR TIMED ACTIVATION OF PROCESS EQUIPMENT SUCH AS STIRRERS, FANS, HEATERS, ETC. (Uses Alarm Output Channels)
- FOUR SETPOINT & PID PARAMETER SETS FOR QUICK RECALL OF SETPOINTS AND/OR GAIN VALUES DURING BATCH OR PROCESS CHANGEOVER
- PROGRAMMABLE USER INPUT FOR CONTROLLER AND SETPOINT PROGRAM CONTROL
- 100 MSEC SAMPLING PERIOD WITH 0.15% ACCURACY
- ON DEMAND AUTO-TUNING OF PID CONTROL SETTINGS
- DUAL LED DISPLAYS FOR SIMULTANEOUS INDICATION OF PROCESS AND SETPOINT OR PROCESS AND PROFILE STATUS
- ACCEPTS EITHER 0 to 10 VDC OR 4 to 20 mA DC INPUT SIGNAL
- FIELD REPLACEABLE AND INTERCHANGEABLE OUTPUT MODULES (Relay, Logic/SSR drive, and Triac)
- OPTIONAL DUAL ALARM OUTPUTS (Uses Output Modules)
- OPTIONAL SECONDARY OUTPUT (Uses Output Module)
- OPTIONAL LINEAR 4 to 20 mA OR 0 to 10 VDC OUTPUT FOR CONTROL OR PROCESS RE-TRANSMISSION
- OPTIONAL RS485 SERIAL COMMUNICATIONS INTERFACE
- OPTIONAL TYPE 4X/IP65 SEALED FRONT BEZEL

### DESCRIPTION

The PSC is a setpoint controller suitable for time vs. process control applications. The PSC Controller accepts either a 0 to 10 VDC or a 4 to 20 mA DC input signal, precisely scales the process signal, according to programmable scaling points, and provides an accurate output control signal (time proportional or linear) to maintain a process at the desired control point. A comprehensive set of easy to use steps allows the controller to satisfy various applications. The user input can be programmed to perform a variety of controller functions.

Dual 4-digit displays allow viewing of the measured process value and setpoint or the process and profile status simultaneously. Front panel indicators inform the operator of controller status and output states. Replaceable output modules (Relay, logic/SSR drive or Triac) can be fitted to the main control output, alarm output(s) or timed event output(s), and secondary output.

The PSC has been designed to simplify the set-up and operation of a controlled setpoint profile program. The setpoint program is easily entered and controlled through the front panel. Full display capabilities keep the operator informed of the process value, profile status, output states, and setpoint value.

The controller can operate in the standard PID control mode for both Output 1 and Output 2 with on-demand auto-tune which establishes the PID gain set. The PID gain set can be fine tuned by the operator at any time or may be locked from further modification. The unit can be transferred to the manual control mode providing the operator with direct control of the output.

The PSC features four programs or profile recipes, each with up to eight ramp/soak segments, which can be easily stored and executed at any time. Longer profiles can be achieved by linking one or more profiles together, creating a single profile of up to 32 ramp/soak segments. Process profile conformity is assured during either soak (hold) phases or both ramp and hold phases by an adjustable error band parameter. The program repeat function cycles the profile either continuously or a set number of times. Power-on options automatically re-start, stop, or resume a running profile. The profile can be controlled via the front panel buttons, the user input, or the optional serial communications port.

### DIMENSIONS In inches (mm)

Note: Recommended minimum clearance (behind the panel) for mounting clip installation is 5.5" (140) H x 2.1" (53.4) W.

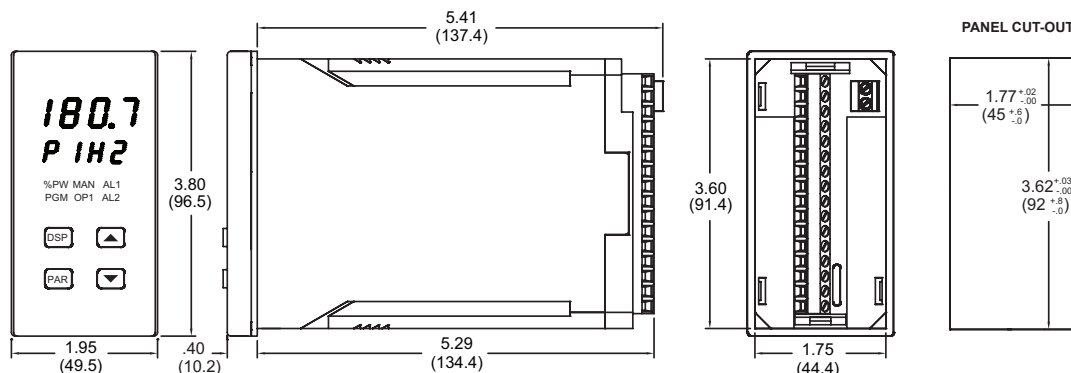

## DESCRIPTION (Cont'd)

Four control points, each having a setpoint and PID parameter set, are available for instant front panel implementation during batch changeover, or other process conditions. A control point may have its PID gain set values disabled when implementing the control point.

The optional RS485 multidrop serial communications interface provides the capability of two-way communication between a PSC unit and other compatible equipment such as a printer, a programmable controller, or a host computer. In multipoint applications the address number of each unit on the line can be programmed from 0 to 99. Up to thirty-two units can be installed on a single pair of wires. The Setpoint value, % Output Power, Setpoint Ramp Rate, etc. can be interrogated or changed by sending the proper command code via serial communications. Alarm output(s) may also be reset via the serial communications interface option.

Optional alarm output(s) may be configured to operate as a timed event output or as a standard alarm output. As an alarm output it may be configured to activate according to a variety of actions (Absolute HI or LO, Deviation HI or LO, or Band IN or OUT) with adjustable hysteresis. Also, a standby feature suppresses the output(s) on power-up until the process stabilizes outside the alarm region. Timed event output(s) allow the controller to activate other equipment while a programmed profile is running. Each profile can define up to 16 event states (phases), for each output(s).

An optional secondary output is available for processes that require cooling which provides increased control accuracy and response.

The optional linear 4 to 20 mA or 0 to 10 VDC output signal is available to interface with final actuators, chart recorders, indicators, or other controllers. The output signal can be digitally scaled and selected to transmit one of the following:

- % Output Power
- Measurement Value
- Measurement Value Deviation
- Setpoint Value

An optional Type 4X/IP65 rated bezel is available for washdown and/or dirty environments, when properly installed. Modern surface-mount technology, extensive testing, plus high immunity to noise interference, makes the controller extremely reliable in industrial environments.

## SAFETY SUMMARY

All safety related regulations, local codes and instructions that appear in the manual or on equipment must be observed to ensure personal safety and to prevent damage to either the instrument or equipment connected to it. If equipment is used in a manner not specified by the manufacturer, the protection provided by the equipment may be impaired.

Do not use the PSC to directly command motors, valves, or other actuators not equipped with safeguards. To do so, can be potentially harmful to persons or equipment in the event of a fault to the unit. An independent and redundant process limit indicator with alarm outputs is strongly recommended. The indicators should have input sensors and AC power feeds independent from other equipment.

## SPECIFICATIONS

1. **DISPLAY:** Dual 4-digit
  - Upper Process Display:** 0.4" (10.2 mm) Red LED
  - Lower Auxiliary Display:** 0.3" (7.6 mm) Green LED
  - Display Messages:**
    - "LOL" - Appears when measurement exceeds +105% of input range.
    - "ULUL" - Appears when measurement exceeds -5% of input range.
    - "SENS" - Appears when measurement exceeds "LOL" & "ULUL" range.
    - "..." - Appears when display value exceeds + display range.
    - "-..." - Appears when display value exceeds - display range.
2. **POWER:** Switch selectable 115/230 VAC (+10%, -15%) no observable line variation effect, 48 to 62 Hz, 10 VA.
3. **ANNUNCIATORS:**
  - 6 LED Backlight Status Indicators:**
    - %PW - Lower auxiliary display shows power output in (%).
    - PGM - Lower auxiliary display shows profile status or profile time remaining.
    - MAN - Controller is in manual mode.
    - OP1 - Main control output is active.
    - AL1 - Alarm #1 is active.
    - AL2 - Alarm #2 is active (for Dual Alarm Option).
    - OP2 - Secondary output is active (for Secondary Option).
4. **CONTROLS:** Four front panel push buttons for modifying and setup of controller functions and one external input.
5. **SETPOINT PROFILE:**
  - Profiles:** 4
  - Segments Per Profile:** 8 ramp/hold segments (linkable to 32 segments).
  - Ramp Rate:** 0.1 to 999.9 units/minute or no ramp.
  - Hold Time:** Off or from 0.1 to 999.9 minutes, can be extended to 500 hours by linking.
  - Error Band Conformity:** Off or from 1 to 9999 units deviation, + value for

hold phases, - value for both ramp and hold phases.

**Power-On Modes:** Stop, auto-start, or profile resume.

**Start Mode:** Ramps from process value.

**Program Auto Cycle:** 1 to 249, or continuous.

**Event Outputs:** 2, time activated with profile [uses Alarm output(s)].

**Control:** Front panel buttons, user input, or RS485 communications.

### 6. CONTROL POINTS:

**Setpoints:** 4

**PID gain sets:** 4

**Control:** Front panel buttons or user input.

### 7. SIGNAL INPUT:

**Sample Period:** 100 msec

**Response Time:** 300 msec (to within 99% of final value w/step input).

**Signal Overdrive Threshold:**

**10 V Range:** 13 V

**20 mA Range:** 26 mA

**Signal Overdrive Response:**

**Main Control Output:** Programmable preset output.

**Display:** "SENS"

**DC Linear:** Programmable preset output.

**Normal Mode Rejection:** 40 db @ 50/60 Hz (improves with increased digital filtering).

**Common Mode Rejection:** 100 db, DC to 50/60 Hz.

### 8. RANGE AND ACCURACY:

Signal Range	Accuracy (% of Unscaled Reading)	Max. Input	Input Impedance	Resolution
0 to 10 VDC	$\pm(0.15\% + 3 \text{ mV})$	300 VDC	1M $\Omega$	10 mV
0 to 20 mADC	$\pm(0.15\% + 6 \text{ }\mu\text{A})$	200 mADC	10 $\Omega$	10 $\mu\text{A}$

### 9. OUTPUT MODULES (For All Output Channels):

(Optional - Must be ordered separately)

**Relay:**

**Type:** Form-C (Form-A with RS485 option)

**Rating:** 5 Amps @ 120/240 VAC or 28 VDC (resistive load), 1/8 HP @ 120 VAC (inductive load).

**Life Expectancy:** 100,000 cycles at max. rating. (Decreasing load and/or increasing cycle time, increases life expectancy).

**Logic/SSR Drive:** Can drive multiple SSR Power Units.

**Type:** Non-isolated switched DC, 12 VDC typical

**Drive:** 45 mA max.

**Triac:**

**Type:** Isolated, Zero Crossing Detection.

**Ratings:** Voltage: 120/240 VAC

**Max Load Current:** 1 AMP @ 35°C  
0.75 AMP @ 50°C

**Min Load Current:** 10 mA

**Off State Leakage Current:** 7 mA max. @ 60 Hz

**Operating Frequency:** 20 to 500 Hz

**Protection:** Internal Transient Snubber, Fused.

### 10. MAIN CONTROL OUTPUT:

**Control:** PID or ON/OFF.

**Output:** Time proportioning or linear DC.

**Hardware:** Plug-in, replaceable output modules.

**Cycle time:** Programmable.

**Auto-tune:** When performed, sets proportional band, integral time, and derivative time values.

**Probe Break Action:** Programmable.

### 11. SECONDARY OUTPUT (Optional):

**Control:** PID or ON/OFF.

**Output:** Time proportioning or linear DC

**Hardware:** Plug-in, replaceable output modules.

**Cycle time:** Programmable.

**Proportional Gain Adjust:** Programmable.

**DeadBand Overlap:** Programmable.

### 12. LINEAR DC DRIVE (Optional):

With digital scale and offset, programmable deadband and update time.

**4 to 20 mA:**

**Resolution:** 1 part in 3500 typ.

**Accuracy:**  $\pm(0.1\% \text{ of reading} + 25 \text{ }\mu\text{A})$ .

**Compliance:** 10 V (500  $\Omega$  max. loop impedance).

**0 to 10 VDC:**

**Resolution:** 1 part in 3500 typ.

**Accuracy:**  $\pm(0.1\% \text{ of reading} + 35 \text{ mV})$ .

**Min. Load Resistance:** 10 K  $\Omega$  (1 mA max.)

**Source:** % output power, setpoint, deviation, or process value.

(Available for OPI or OP2, but not both.)

## SPECIFICATIONS (Cont'd)

### 13. ALARMS (Optional):

**Hardware:** Plug-in, replaceable output module.

**Modes:** Absolute high acting  
 Absolute low acting  
 Deviation high acting  
 Deviation low acting  
 Inside band acting  
 Outside band acting  
 Timed event output(s)

**Reset Action:** Programmable; automatic or latched.

**Delay:** Programmable; enable or disable.

**Hysteresis:** Programmable.

**Annunciator:** LED backlight for "AL1", "AL2", (*Alarm #2 not available with secondary output*).

### 14. SERIAL COMMUNICATIONS (Optional):

**Type:** RS485 Multi-point, Balanced Interface.

**Communication Format:**

**Baud Rate:** Programmable from 300 to 9600.

**Parity:** Programmable for odd, even, or no parity.

**Frame:** 1 start bit, 7 data bits, 1 or no parity bit, 1 stop bit.

**Unit Address:** Programmable from 0-99, max. of 32 units per line.

**Transmit Delay:** 100 msec min., 200 msec max.

**RS485 Common:** Isolated from signal input common.

**Auto Print Time:** Off to 9999 seconds between print-outs.

### 15. USER INPUT: $V_{IN\ MAX} = 5.25\ VDC$ , $V_{IL} = 0.85\ V_{MAX}$ ; $V_{IH} = 2.0\ V_{MIN}$

**Response time:** 100 msec max.

**Functions:**

Program Lock	Print Request
Integral Action Lock	Load Control Point
Auto/Manual Transfer	Run/Hold Profile 1
Setpoint Ramp Select	Run/Stop Profile 1
Reset Alarms	

### 16. ENVIRONMENTAL CONDITIONS:

**Operating Temperature Range:** 0° to 50°C

**Storage Temperature Range:** -40° to 80°C

**Vibration to IEC 68-2-6:** Operational 5-150 Hz, 1 g

**Shock to IEC 68-2-27:** Operational 5 g

**Span Drift:** 90 ppm/°C

**Zero Drift:** 0 to 10 VDC Range - 0.2 mV/°C

4 to 20 mA DC Range - 0.5  $\mu$ A/°C

**Relative Humidity:** Less than 85% RH (non-condensing)

**Altitude:** Up to 2000 meters

### 17. CERTIFICATIONS AND COMPLIANCES:

**CE Approved**

EN 61326-1 Immunity to Industrial Locations

Emission CISPR 11 Class A

EN 61010-1

RoHS Compliant

UL Recognized Component: File #E156876

UL Listed: File #E137808

Type 2 Enclosure rating (Face only) for PSC0

Type 4X/IP65 Enclosure rating (Face only) for PSC1

*Refer to EMC Installation Guidelines section of the manual for additional information.*

### 18. CONNECTION: Jaw-type terminal block.

### 19. CONSTRUCTION:

**Front Panel:** Flame and scratch resistant tinted plastic.

**Case:** High impact black plastic. (Mounting collar included).

**Type 4X/IP65 model only:** Sealed bezel utilizing 2 captive mounting screws (panel gasket included). This unit is rated for Type 4X/IP65 indoor use. Installation Category II, Pollution Degree 2.

### 20. WEIGHT: 1.3 lbs. (0.6 kgs)

## BASIC OPERATION

The PSC controls the process profile of a system by measuring the input signal, comparing it to the setpoint value of the profile in progress, and calculates the new output power value by use of a modified PID control algorithm. The unit controls the system with the new output power value so the process value conforms to the profile. The PID control algorithm incorporates features which provide high control accuracy and low disturbance overshoot.

## FRONT PANEL FEATURES

In the normal display mode, the unit will display the scaled process value in the upper display. One of five other parameters may be selected for viewing in the lower display:

- Target setpoint
- % Output Power
- Profile Status
- Profile phase time remaining
- Blank the lower display.

The profile status display indicates the active program number with the current ramp or hold phase of the program. The profile can be started, stopped, advanced, etc., from the front panel when the profile status display is viewed, if not locked from access.

The phase time remaining display, shows the time remaining in a ramp or hold phase and, if not locked from access, may be changed on-line to effect temporary changes to the profile. Additionally, the target setpoint and % output power (manual mode only) may also be changed on-line or locked from operator access.

From the normal operating mode, parameters are selected by use of the PAR button and modified by use of the UP and DOWN buttons. Parameters are then entered by the PAR button, which advances the user to the next parameter. Pressing the DSP button immediately returns the controller to the normal operating mode from any parameter module. The controller configuration and parameter settings are stored in an internal E<sup>2</sup>PROM device.

## HARDWARE FEATURES

The fast 100 msec input sampling rate provides quick controller response to a process disturbance for excellent process control. Measurement accuracy of 0.15% provides closer process control conforming to the desired control setpoint value.

The unit will accept either a 0 to 10 VDC or a 4 to 20 mA DC input signal. The A.C. input power is switch selectable, allowing the unit to operate from either 115 VAC or 230 VAC. Since the controller is serviceable from the front of the panel, the output modules may be easily changed or replaced without disturbing the wiring behind the panel and NO re-programming is required. The standard model simply requires pressing a latch to remove the unit. The Type 4X/IP65 rated model utilizes two panel securing screws and a neoprene gasket to guarantee a water tight seal, when properly installed.

Low-drift, highly stable circuit design ensures years of reliable and accurate process control. The recommended two year re-calibration interval is easily accomplished via the programming menu.

Type 4X/IP65 BEZEL

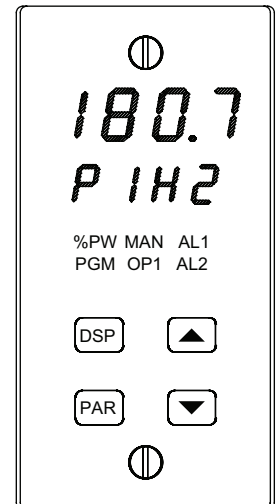

## CONFIGURATION MODE

The configuration modules serve to provide the basic set-ups required by the controller. It is divided into sections which group together related programming steps, such as inputs, outputs, alarms, etc. Upon completion of each section, the program returns to the configuration selection stage, which allows the user to return to the normal display mode, or advance to a later configuration stage.

### Configuration 1, Inputs

- "TYPE" - Select current or voltage
- "dCPt" - Select scaled display decimal point position
- "rnd" - Enter rounding increment and trailing zeros for scaled display
- "FLtr" - Select degree of input filtering
- "dSP1" - Enter display reading for scaling point #1
- "INP1" - Key-in or apply signal level for scaling point #1
- "dSP2" - Enter display reading for scaling point #2
- "INP2" - Key-in or apply signal level for scaling point #2
- "SPLO" - Enter setpoint lower limit
- "SPHI" - Enter setpoint higher limit
- "SPrP" - Enter setpoint ramp rate
- "InPt" - Select user input function

### Configuration 2, Outputs

- "CYCt" - Enter time proportioning cycle time
- "OPAC" - Select control action
- "OPLO" - Enter output power low limit
- "OPHI" - Enter output power high limit
- "OPFL" - Enter signal overdrive power preset
- "CHYS" - Enter ON/OFF control hysteresis
- "tcod" - Select auto-tuning damping
- "ANAS" - Select linear DC output assignment \*
- "ANLO" - Enter linear DC low scaling value \*
- "ANHI" - Enter linear DC high scaling value \*

### Configuration 3, Parameter lock-outs

- "SP" - Select degree of setpoint access
- "OP" - Select degree of power access
- "P-CS" - Select degree of profile status access
- "P-tr" - Select degree of phase time remaining access
- "bdSP" - Enable blank display
- "CodE" - Enter parameter access code
- "Pid" - Select degree of PID access
- "AL" - Select degree of alarm access \*
- "ALrS" - Enable manual reset of alarms \*
- "CPAC" - Enable control point access
- "PrAC" - Enable ramp/hold program access
- "trnF" - Enable automatic/manual transfer
- "tUNE" - Enable auto-tune invocation

\* These parameters may not appear due to option configuration or other programming.

### Configuration 4, Alarms \*

- "Act 1" - Select operation mode of alarm #1
- "rSt1" - Select reset mode of alarm #1
- "Stb1" - Enable activation delay of alarm #1
- "AL-1" - Enter value for alarm #1
- "Act2" - Select operation mode of alarm #2
- "rSt2" - Select reset mode of alarm #2
- "Stb2" - Enable activation delay of alarm #2
- "AL-2" - Enter value for alarm #2
- "AHYS" - Enter hysteresis value for both alarms

### Configuration 5, Secondary Output \*

- "CYC2" - Enter time proportioning cycle time
- "GAN2" - Enter relative gain
- "db-2" - Enter deadband or overlap

### Configuration 6, Serial Communications \*

- "bAUd" - Select baud rate
- "PArb" - Select parity bit
- "Addr" - Enter unit address number
- "Abrv" - Select abbreviated or full mnemonic transmissions
- "PrAt" - Enter automatic print rate
- "PoPt" - Select parameters to be included in print-out

### Configuration 7, Control Points

- "CSEt" - Select control point number for set-up 1, 2, 3, & 4
- "SP-x" - Enter setpoint value for selected control point
- "PID" - Select if PID gain set to be loaded with setpoint
- "PB-x" - Enter proportional band for selected control point \*
- "It-x" - Enter integral time for selected control point \*
- "dt-x" - Enter derivative time for selected control point \*

### Configuration 8, Profiles

- "PSEt" - Select profile or event output for set-up 1, 2, 3, or 4
- "PnCC" - Enter program-repeat cycle count for selected profile
- "PnLN" - Select link option for selected profile
- "PnSt" - Enter power-down resume status for selected profile
- "PnEb" - Enter error band for process conformity for selected profile
- "Pnr1" - Enter ramp rate 1 for selected profile \*
- "PnL1" - Enter setpoint level 1 for selected profile \*
- "PnH1" - Enter hold time 1 for selected profile \*
- .
- .
- "Pnr8" - Enter ramp rate 8 for selected profile \*
- "PnL8" - Enter setpoint level 8 for selected profile \*
- "PnH8" - Enter hold time 8 for selected profile \*
- "Pn 1" - Select event outputs at phase 1 for selected profile \*
- .
- .
- "Pn16" - Select event outputs at phase 16 for selected profile \*

### Configuration 9, Factory Service Operations

(Detailed in the operator's manual)

## SETPOINT FEATURES

The controller's setpoint can be protected from out of range values, by programming the setpoint range limit values. Additionally, safeguards from inadvertent data entry can also be programmed.

The setpoint ramp feature ramps the setpoint value at start-up or any time a setpoint change is made, at a user programmable rate, independent of a programmed profile. This feature reduces shock to the process and also helps to minimize overshoot.

The active setpoint, which can be a running profile, may also be transmitted by the linear DC output for slave control loops.

Four control points are available which can be implemented at any time. Each control point is programmed independently, with each having a setpoint and a PID gain set value. With gain value changes, the output power control signal will not "bump" resulting in a smooth control transition.

## INPUT FEATURES

A programmable input filter can be used to stabilize readings from a process with varying or oscillating characteristics, helping to provide better process control.

Scaling points allow the controller to display in any engineering unit; flow, level, pressure temperature, etc. Scaling points are used in conjunction with the programmable rounding increment to stabilize a jittery or otherwise hard to read process signal for better indication.

A programmable User Input is available to control a variety of controller functions, such as profile control, auto/manual transfer, serial communication print requests, etc.

## OUTPUT FEATURES

Programmable output power limits provide protection for processes where too much power can cause damage. Automatic signal overdrive detection can be used to define the state of the output channels, when this situation occurs. With adjustable time proportioning-cycle time and programmable D.C. Linear output, the controller can satisfy a wide variety of output requirements.

During execution of a profile, two independent timed event outputs are available to control or signal other equipment. The event outputs use the alarm channels.

The RS485 Communication option allows the user to access various controller parameters such as the setpoint, % output power, % proportional band, etc. The controller may be setup to transmit various parameters at a programmable automatic print rate.

## AUTO-TUNE

The model PSC has an auto-tune feature which, on demand, automatically determines the PID control parameters for a particular process. After completion of auto-tune, the PID parameters are automatically optimized for that process and loaded into nonvolatile memory. The operator may view and modify the parameters as desired.

Auto-tune may be invoked at start-up, while ramping, or at setpoint, depending on the process requirements. A programmable auto-tune damping factor produces various levels of process control and response characteristics.

## PROFILE PROGRAMMING

Profiles are programmed independently of each other and are separate from the configuration of other controller parameters. Each profile has parameters for error band (profile conformity), linking, auto-start and program repeat cycles. Profiles may be altered during execution, so changes take effect as the profile advances.

## CONTROLLER PROGRAMMING

The model PSC has been designed to reduce the operator interaction with the controller while still maintaining a high degree of control accuracy and user flexibility. Front panel program disable allows all of the controller's set-ups to be locked-out from further operator intervention after the initial parameter set-up.

The programming of the controller is divided into four sections:

- Hidden Mode
- Protected Mode
- Unprotected Mode
- Configuration Mode

These four programming modes allow the controller to adapt to any required user-interface level.

## UNPROTECTED PARAMETER MODE

The unprotected mode is accessible when program disable is inactive or when the proper access code number from the protected mode is entered. Only from this mode can the configuration modes be accessed.

- "SP" - Enter setpoint \*
- "OPOF" - Enter %output power offset \*
- "OP" - Enter output power \*
- "ProP" - Enter proportional band
- "Intt" - Enter integral time \*
- "dErt" - Enter derivative time \*
- "AL-1" - Enter value for alarm #1 \*
- "AL-2" - Enter value for alarm #2 \*
- "CNFP" - Select basic configuration module
- "End" - Return to normal display mode

## PROTECTED PARAMETER MODE \*

The protected mode is accessible when program disable is active, also this mode prevents access to the configuration modes without the proper access code number. Only the parameters that are selected in the configuration 3 parameter lock-outs section can be accessed.

- "ProP" - Enter proportional band
- "Intt" - Enter integral time
- "dErt" - Enter derivative time
- "AL-1" - Enter value for alarm #1
- "AL-2" - Enter value for alarm #2
- "CodE" - Enter access value to unprotected mode

\* These parameters may not appear due to option configuration or other programming.

## HIDDEN FUNCTIONS MODE \*

The hidden mode is accessible from the normal operating mode by holding the PAR button for 3 seconds. The five functions in this mode may be locked-out individually in configuration 3 parameter lock-outs section.

- "CP" - Invoke control point x
- "Prun" - Control ramp/hold profile state
- "trnF" - Transfer between automatic (PID) control and Manual control
- "tUNE" - Invoke/Cancel PID auto-tune
- "ALrS" - Reset latched alarms

\* These parameters may not appear due to option configuration or other programming.

## OUTPUT VARIATIONS WITHOUT RS485 OPTION

The Dual Alarm or the Secondary with Alarm output, without the RS485 option, has independent outputs. Therefore, the secondary output and/or alarm output(s) can be installed with any combination of output modules.

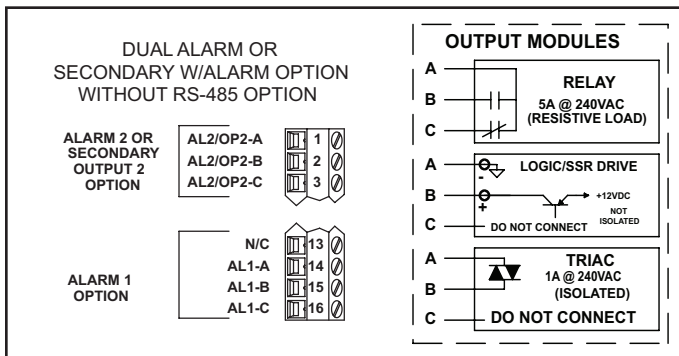

## OUTPUT VARIATIONS WITH RS485 OPTION

The Dual Alarm or the Secondary with Alarm output, with RS485 option, does not have independent outputs. In this case, the secondary output and/or alarm output(s) must have the same type of output modules installed since they share the common terminal.

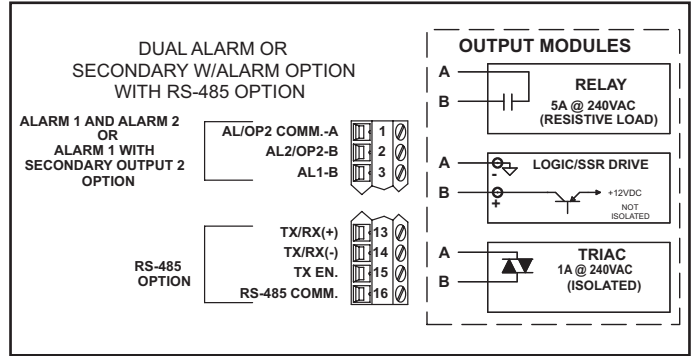

## OUTPUT MODULES

Units equipped with RS485 option must have the Dual Alarm or Secondary w/alarm options fitted with the same type of output modules. The controller's main output (OP1) can be fitted with any output module. Output modules are shipped separately and must be installed by the user.

### TYPICAL CONNECTIONS

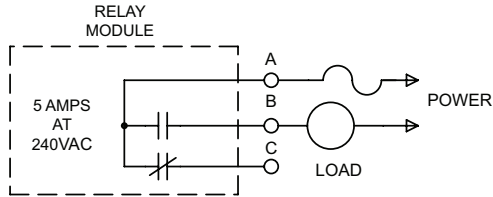

#### Relay:

- Type:** Form -C (Form-A with RS485 option only)
- Rating:** 5 Amps @ 120/240 VAC or 28 VDC (resistive load), 1/8 HP @ 120 VAC (inductive).
- Life Expectancy:** 100,000 cycles at maximum load rating. (Decreasing load and/or increasing cycle time, increases life expectancy).

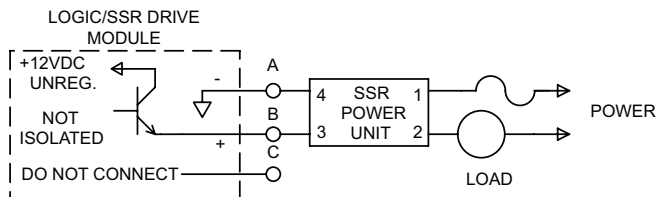

#### Logic/SSR Drive:

- can drive multiple SSR Power Units.
- Type:** Non-isolated switched DC, 12 VDC typical.
- Drive:** 45 mA max.

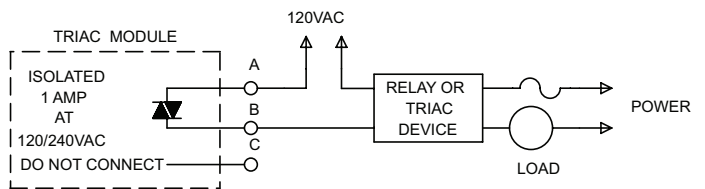

#### Triac:

- Type:** Isolated, Zero Crossing Detection.
- Rating:** Voltage: 120/240 VAC. Max. Load Current: 1 Amp @ 35°C, 0.75 Amp @ 50°C. Min. Load Current: 10 mA. Off State Leakage Current: 7 mA max @ 60 Hz. Operating Frequency: 20 to 500 Hz. Protection: Internal Transient Snubber, Fused.

## APPLICATION

A chemical treatment process requires the PH level of a solution be ramped at staged levels over specific time periods during start-up. The PSC unit is installed to meet this requirement.

After the tank is filled, the PSC's user input is triggered to run profile 1 to start the process. Alarm output 2 signals the operator if the PH level deviates outside the running profile. The error band (profile conformance) is programmed to the desired value to prevent the PH level from deviating from the programmed setpoint profile. Timed event output 1 signals that the profile process is complete.

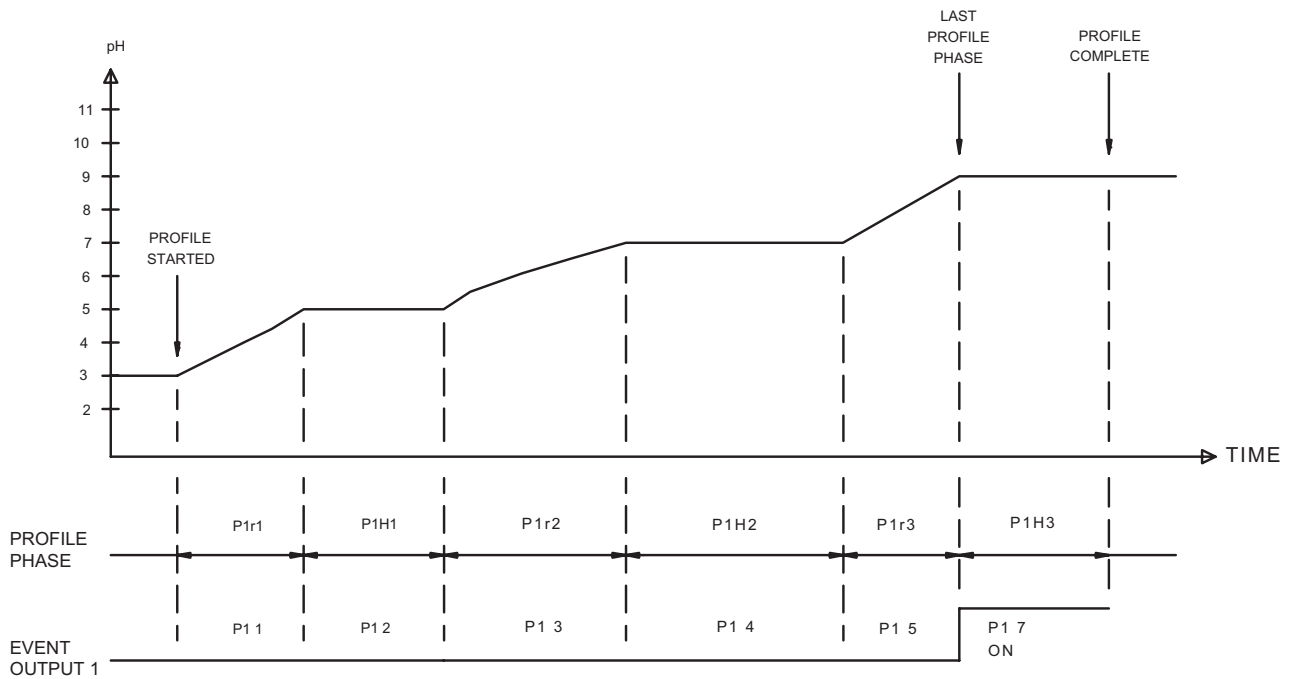
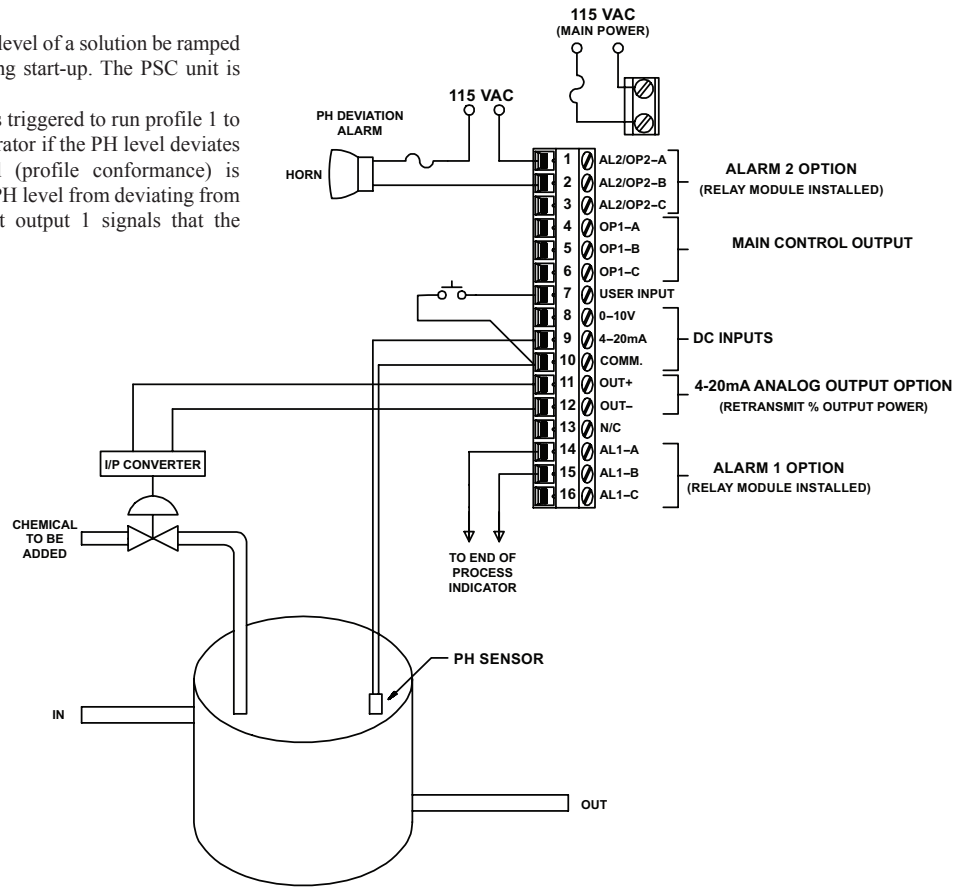

## ORDERING INFORMATION

MODEL NO	DESCRIPTION	Type 4X/IP65 BEZEL	4 to 20 mA ANALOG OUTPUT	0 to 10 VDC ANALOG OUTPUT	ALARM OUTPUTS	SECONDARY OUTPUT	RS485 COM	PART NUMBER
PSC	Process Setpoint Controller	YES	YES	NO	2	NO	NO	PSC11001
		YES	YES	NO	2	NO	YES	PSC11004
		YES	YES	NO	1	YES	YES	PSC11005
		YES	NO	YES	2	NO	YES	PSC12004
		YES	NO	YES	1	YES	YES	PSC12005
	Relay Module							OMD00000
	Triac Module							OMD00001
	Logic/SSR Drive Module							OMD00003
PMK5	Panel Mount Adapter Kit (1/4 DIN to 1/8 DIN)							PMK50000
RLY	45 A Single Phase Panel Mount SSR							RLY50000
	25 A Single Phase DIN Rail Mount SSR							RLY60000
	40 A Single Phase DIN Rail Mount SSR							RLY6A000
	25 A Three Phase DIN Rail Mount SSR							RLY70000

These models have dual alarm outputs, or single alarm with secondary outputs, with shared common terminals (Form A Type). As a result, these outputs should be fitted with the same type of output module. The main output (OP1) may be fitted with any type of output

*Note: Output Modules are NOT supplied with the controller. When specifying the controller, be sure to purchase the appropriate output module for the Main Control Output and if necessary, the alarm output(s) and secondary output. The controller can be fitted with any combination of output modules that do not have the RS485 option.*

*The Logic/SSR Drive Module is a switched DC source, intended to drive the DC input of an SSR power unit. It should never be connected to a line voltage.*

*All modules are shipped separately and must be installed by the user.*



### **LIMITED WARRANTY**

The Company warrants the products it manufactures against defects in materials and workmanship for a period limited to two years from the date of shipment, provided the products have been stored, handled, installed, and used under proper conditions. The Company's liability under this limited warranty shall extend only to the repair or replacement of a defective product, at The Company's option. The Company disclaims all liability for any affirmation, promise or representation with respect to the products.

The customer agrees to hold Red Lion Controls harmless from, defend, and indemnify RLC against damages, claims, and expenses arising out of subsequent sales of RLC products or products containing components manufactured by RLC and based upon personal injuries, deaths, property damage, lost profits, and other matters which Buyer, its employees, or sub-contractors are or may be to any extent liable, including without limitation penalties imposed by the Consumer Product Safety Act (P.L. 92-573) and liability imposed upon any person pursuant to the Magnuson-Moss Warranty Act (P.L. 93-637), as now in effect or as amended hereafter.

No warranties expressed or implied are created with respect to The Company's products except those expressly contained herein. The Customer acknowledges the disclaimers and limitations contained herein and relies on no other warranties or affirmations.

Red Lion Controls  
Headquarters  
20 Willow Springs Circle  
York PA 17406  
Tel +1 (717) 767-6511  
Fax +1 (717) 764-0839

Red Lion Controls  
Europe  
Softwareweg 9  
NL - 3821 BN Amersfoort  
Tel +31 (0) 334 723 225  
Fax +31 (0) 334 893 793

Red Lion Controls  
India  
201-B, 2nd Floor, Park Centra  
Opp 32 Mile Stone, Sector-30  
Gurgaon-122002 Haryana, India  
Tel +91 984 487 0503

Red Lion Controls  
China  
Unit 302, XinAn Plaza  
Building 13, No.99 Tianzhou Road  
ShangHai, P.R. China 200223  
Tel +86 21 6113 3688  
Fax +86 21 6113 3683