



Chipsmall Limited consists of a professional team with an average of over 10 year of expertise in the distribution of electronic components. Based in Hongkong, we have already established firm and mutual-benefit business relationships with customers from,Europe,America and south Asia,supplying obsolete and hard-to-find components to meet their specific needs.

With the principle of “Quality Parts,Customers Priority,Honest Operation,and Considerate Service”,our business mainly focus on the distribution of electronic components. Line cards we deal with include Microchip,ALPS,ROHM,Xilinx,Pulse,ON,Everlight and Freescale. Main products comprise IC,Modules,Potentiometer,IC Socket,Relay,Connector.Our parts cover such applications as commercial,industrial, and automotives areas.

We are looking forward to setting up business relationship with you and hope to provide you with the best service and solution. Let us make a better world for our industry!



## Contact us

Tel: +86-755-8981 8866 Fax: +86-755-8427 6832

Email & Skype: info@chipsmall.com Web: www.chipsmall.com

Address: A1208, Overseas Decoration Building, #122 Zhenhua RD., Futian, Shenzhen, China



## PT-39-L51-TE

### Deep Red and Green LED Chipset

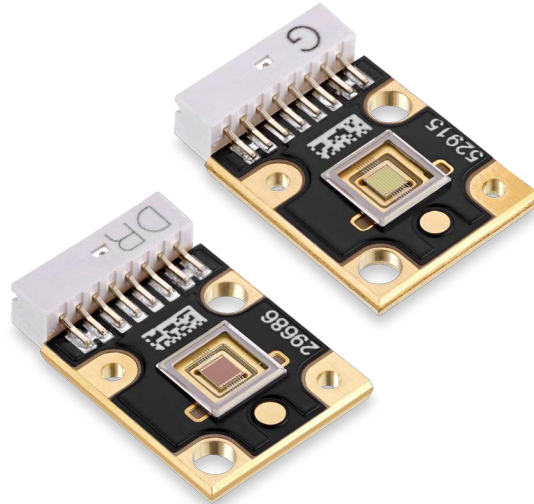

#### Table of Contents

Technology Overview .....2

Binning Structure .....3

Optical & Electrical Characteristics .....4

Optical & Electrical Characteristics Graphs .....5

Optical Spectrum .....8

Thermal Resistance .....9

Mechanical Dimensions .. 10

#### Features:

---

- Matched Chipset with 2.09 mm × 1.87 mm (3.9 mm<sup>2</sup>) emitting area
- Ultra-low thermal resistance, 1.2°C/W junction-to-heat sink
- Targeted peak wavelengths: Deep-red 650 nm, Green 520 nm
- LED mounted on copper core-PCB for easier thermal and optical integration
- RoHS (EU-2002/95/EC Directive) and REACH compliant

#### Applications

---

- Life Sciences
- Medical
- Microdisplay
- Fiber Coupling
- Horticulture

## Technology Overview

Luminus LEDs benefit from innovations in device technology, chip packaging and thermal management. This suite of technologies give engineers and system designers the freedom to develop solutions both high in power and efficiency.

### Luminus Technology

Luminus' technology enables large area LED chips to emit photons uniformly over the entire LED chip surface. The intense optical power density produced by these devices facilitate designs which replace arc and halogen lamps where arrays of traditional high power LEDs cannot.

Luminus engineers their parts to maximize light extraction and to emit with a Lambertian far-field distribution pattern. The design maximizes efficiency and allows for flexible optical designs.

### Packaging Technology

Thermal management is critical in high power LED applications. Luminus PT-39 LEDs have the lowest thermal resistance of any LED on the market with a thermal resistance from junction to heat sink of 1.2°C/W. This allows the LED to be driven at higher current densities while maintaining a low junction temperature, thereby resulting in brighter solutions and longer lifetimes.

### Reliability

Luminus LEDs are designed from the ground up to deliver one of the most reliable light sources in the world today. Luminus LEDs have passed a rigorous suite of environmental and mechanical stress tests, including mechanical shock, vibration, temperature cycling and humidity, and have been fully qualified for use in extreme high power and high current applications. With very low failure rates and median lifetimes that typically exceed 10,000 hours, Luminus LEDs are ready for even the most demanding applications.

### Environmental Benefits

Luminus LEDs help reduce power consumption and the amount of hazardous waste entering the environment. All Luminus LED products manufactured by Luminus are RoHS compliant and free of hazardous materials, including lead and mercury.

## Understanding Luminus LED Test Specifications

Every Luminus LED is fully tested to ensure that it meets the high quality standards expected from Luminus' products.

### Testing Temperature

Luminus core board products are typically measured in such a way that the characteristics reported agree with how the devices will actually perform when incorporated into a system. This measurement is accomplished by mounting the devices on a 40°C heat sink. This method of measurement ensures that Luminus LEDs perform in the field just as they are specified.

### Operating Points

The tables on the following pages provide typical optical and electrical characteristics. The LEDs can be operated over a wide range of drive conditions (currents from <1A to 12 A, and duty cycle from <1% to 100%).

PT-39 devices are production specified at 7.5 A. Any other values shown are for additional reference at other possible drive conditions.



### PT-39 Binning Structure

PT-39 LEDs are specified for luminous flux and chromaticity/wavelength at a drive current of 7.5 A (1.92 A/mm<sup>2</sup>) and placed into one of the following Power Bins and Wavelength Bins:

#### Power Bins

Color	Power Flux Bin (FF)	Minimum Flux (W)	Maximum Flux (W)
Deep Red	BD	2.6	2.8
	BE	2.8	3.0
	BF	3.0	3.2
Green	CD	2.6	2.8
	CE	2.8	3.0
	CF	3.0	3.2

\*Note: Luminus maintains a +/- 6% tolerance on power measurements.

#### Peak Wavelength Bins

Color	Wavelength Bin (123)	Minimum Wavelength (nm)	Maximum Wavelength (nm)
Deep Red	R10	645	650
	R11	650	655
Green	G2	510	515
	G3	515	520
	G4	520	525
	G5	525	530

**Reference Optical & Electrical Characteristics ( $T_{hs} = 40^{\circ}\text{C}$ )<sup>1,2</sup>**

	Symbol	Deep Red	Green	Unit
Current Density <sup>3,4</sup>	$j$	1.92	1.92	A/mm <sup>2</sup>
Forward Voltage	$V_{Fmin}$	2.1	3.0	V
	$V_{F,typ}$	2.3	5.0	V
	$V_{Fmax}$	3.0	5.5	V
Radiometric Flux <sup>5</sup>	$\Phi_{typ}$	2.7	2.7	W
Radiometric Flux Density <sup>5</sup>	$\Phi_R$	0.74	0.74	W/mm <sup>2</sup>
Peak Wavelength Range	$\lambda$	645 - 655	510 - 530	nm
Peak Wavelength <sup>5</sup>	$\lambda_p$	650	520	nm
FWHM <sup>5</sup>	$\Delta\lambda_{1/2}$	20	33	nm
	Symbol	Deep Red	Green	Unit
Emitting Area		3.9	3.9	mm <sup>2</sup>
Emitting Area Dimensions		1.87 x 2.09	1.87 x 2.09	mm x mm

**Absolute Maximum Ratings**

	Symbol	Deep Red	Green	Unit
Minimum Current (CW or Pulsed) <sup>6</sup>		200	200	mA
Maximum Current CW <sup>6</sup>		10	10	A
Maximum Current Pulsed <sup>6</sup>		12	12	A
Maximum Junction Temperature <sup>6,7</sup>	$T_{jmax}$	110	150	°C
Storage Temperature Range		-40 to +100	-40 to +100	°C

Note 1: Data verified using NIST traceable calibration standard.

Note 2: All data are based on test conditions with a constant heat sink temperature  $T_{hs} = 40^{\circ}\text{C}$  under pulse testing conditions. Pulse duration 20 msec, single pulse.

Note 3: Unless otherwise noted, values listed are typical. Devices are production tested and specified at 7.5 A.

Note 4: Listed drive conditions are typical for common applications. Drive current and duty cycle should be adjusted as necessary to maintain the junction temperature desired to meet application lifetime requirement.

Note 5: Typical values

Note 6: Product performance and lifetime data is specified at recommended forward drive currents. Sustained operation at or near absolute minimum or maximum currents may result in reduced device performance or lifetime compared to operation at recommended forward currents.

Note 7: Sustained operation at or above Maximum Operating Junction Temperature ( $T_{jmax}$ ) will result in reduced device life time.

## Optical & Electrical Characteristics Graphs

### Relative Power vs $I_f$ [A]

#### Deep Red

Relative Power vs Forward Current ( $I_f$ )  
Normalized to 6 A and  $T_j = 100^\circ\text{C}$

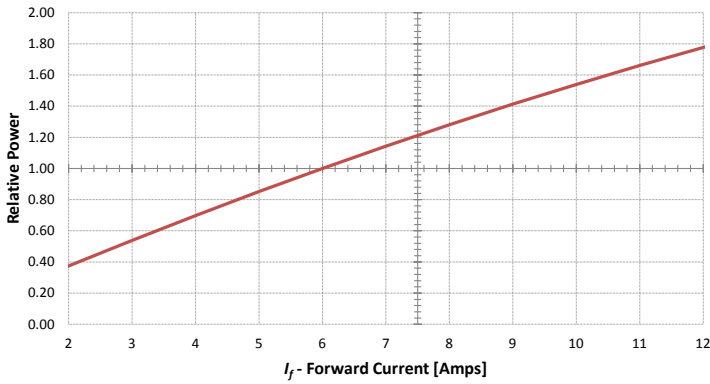

#### Green

Relative Power vs Forward Current ( $I_f$ )  
Normalized to 6 A and  $T_j = 120^\circ\text{C}$

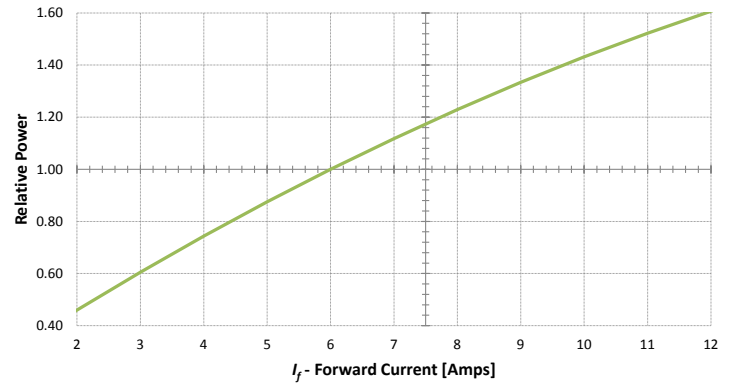

### Change in $V_f$ vs $I_f$ [A]

#### Deep Red

Change in Forward Voltage ( $V_f$ ) vs Forward Current ( $I_f$ )  
Referenced to 6 A and  $T_j = 100^\circ\text{C}$

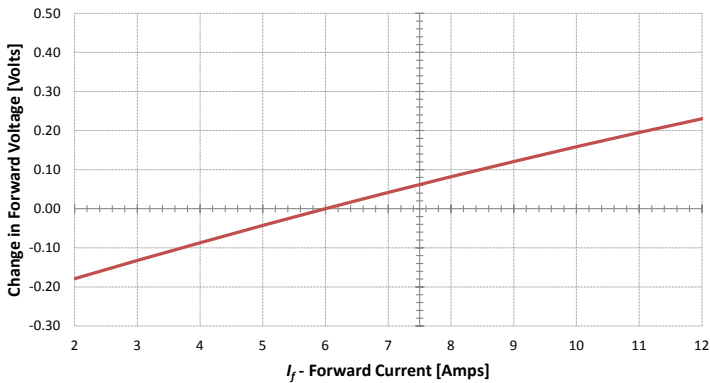

#### Green

Change in Forward Voltage ( $V_f$ ) vs Forward Current ( $I_f$ )  
Referenced to 6 A and  $T_j = 120^\circ\text{C}$

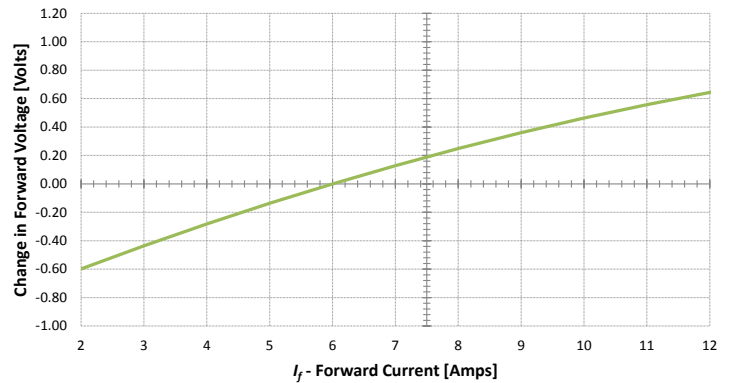

### Change in $\lambda_p$ [nm] vs $I_f$ [A]

#### Deep Red

Change in Peak Wavelength ( $\lambda_p$ ) vs Forward Current ( $I_f$ )  
Referenced to 6 A and  $T_j = 100^\circ\text{C}$

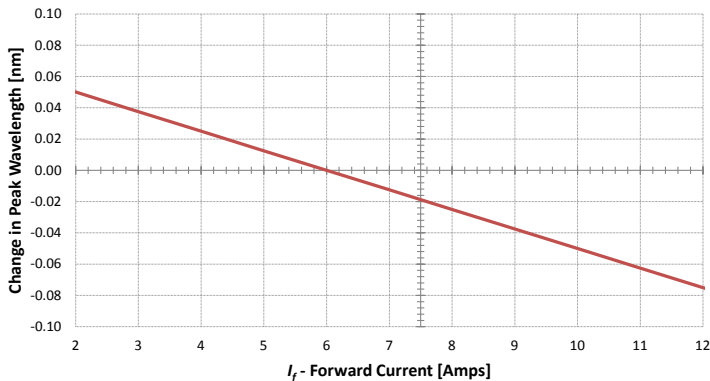

#### Green

Change in Peak Wavelength ( $\lambda_p$ ) vs Forward Current ( $I_f$ )  
Referenced to 6 A and  $T_j = 120^\circ\text{C}$

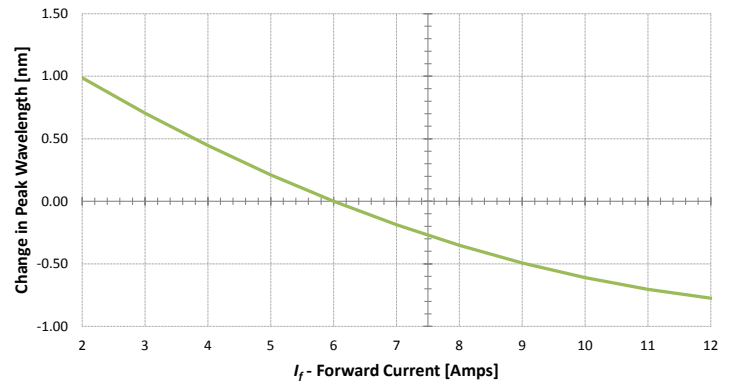

## Optical and Electrical Characteristics Graphs

### Change in FWHM vs $I_f$ [A]

#### Deep Red

Change in Full-Width Half-Maximum vs Forward Current ( $I_f$ )  
Referenced to 6 A and  $T_j = 100^\circ\text{C}$

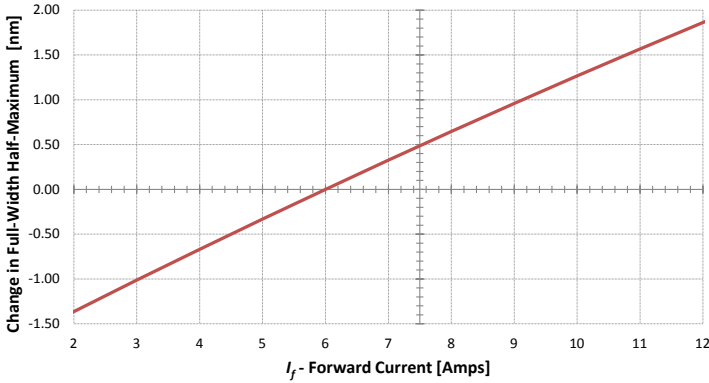

#### Green

Change in Full-Width Half-Maximum vs Forward Current ( $I_f$ )  
Referenced to 6 A and  $T_j = 120^\circ\text{C}$

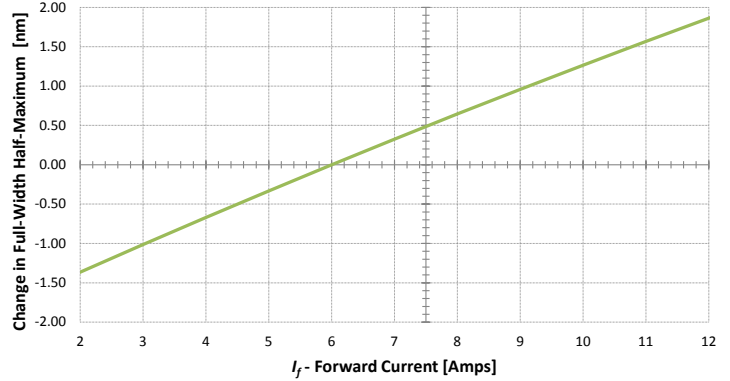

### Relative Power vs $T_j$ [ $^\circ\text{C}$ ]

#### Deep Red

Relative Power vs Junction Temperature ( $T_j$ )  
Normalized to  $80^\circ\text{C}$

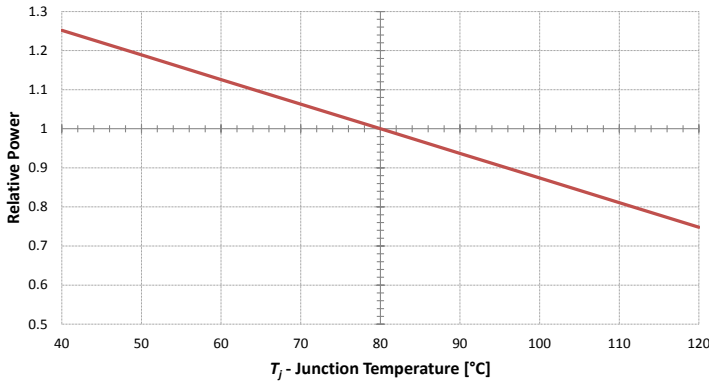

#### Green

Relative Power vs Junction Temperature ( $T_j$ )  
Normalized to  $80^\circ\text{C}$

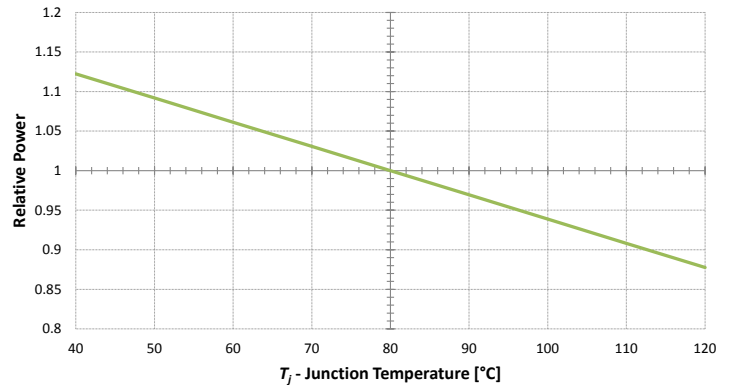

### Change in $V_f$ vs $T_j$ [ $^\circ\text{C}$ ]

#### Deep Red

Change in Forward Voltage ( $V_f$ ) vs Forward Current ( $I_f$ )  
Referenced to 6 A and  $T_j = 100^\circ\text{C}$

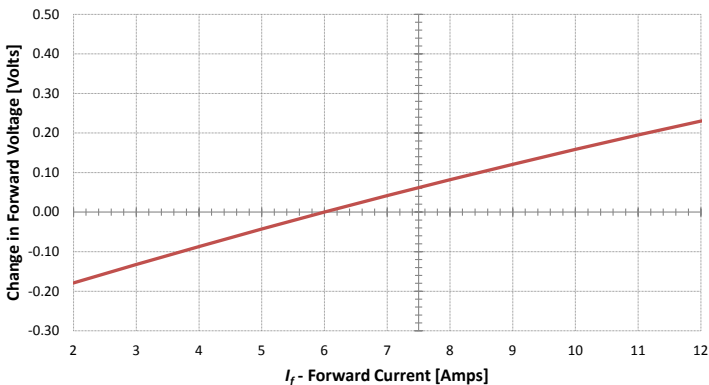

#### Green

Change in Forward Voltage ( $V_f$ ) vs Junction Temperature ( $T_j$ )  
Referenced to  $80^\circ\text{C}$

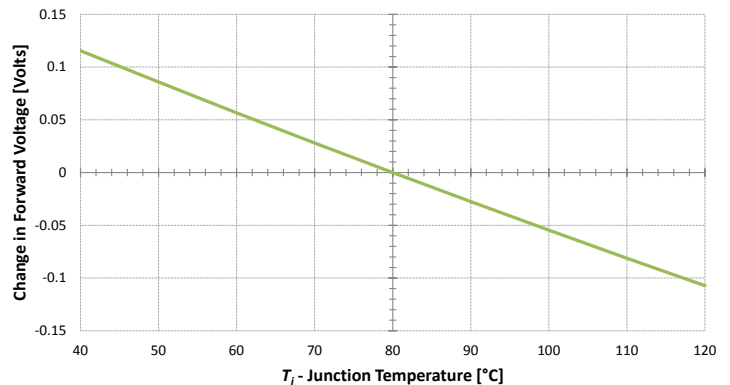

**Optical and Electrical Characteristics Graphs**
**Change in  $\lambda_p$  vs  $T_j$  [°C]**
**Deep Red**

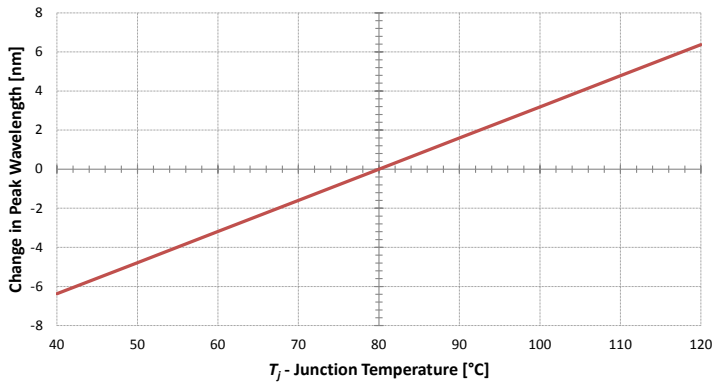
 Change in Peak Wavelength ( $\lambda_p$ ) vs Temperature ( $T_j$ )  
 Referenced to 80°C

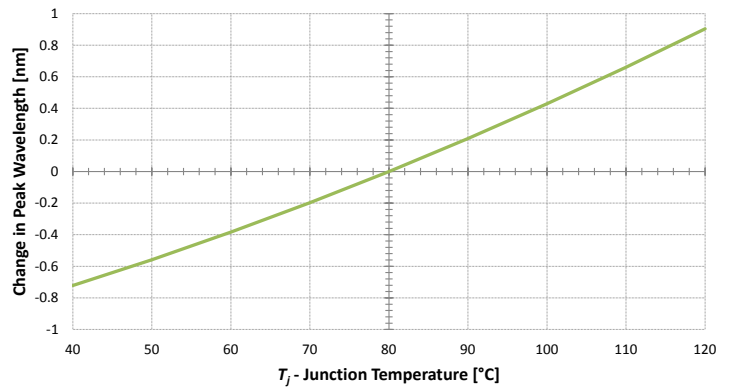
**Green**

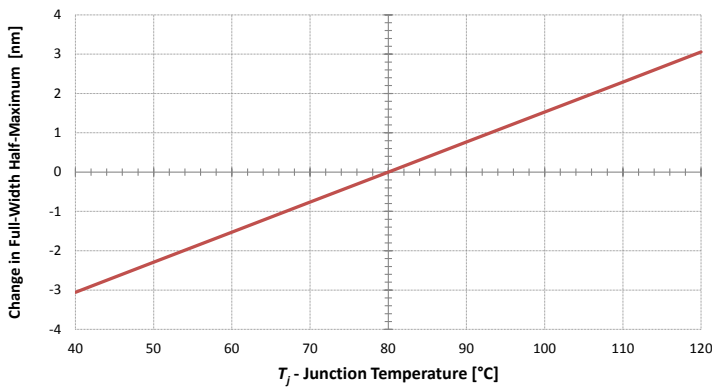
 Change in Peak Wavelength ( $\lambda_p$ ) vs Temperature ( $T_j$ )  
 Referenced to 80°C

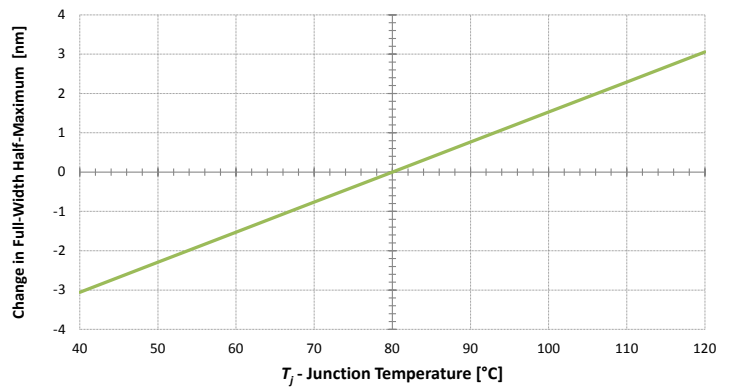
**Change in FWHM vs  $T_j$  [°C]**
**Deep Red**

 Change in Full-Width Half-Maximum (FWHM) vs Temperature ( $T_j$ )  
 Referenced to 80°C

**Green**

 Change in Full-Width Half-Maximum (FWHM) vs Temperature ( $T_j$ )  
 Referenced to 80°C

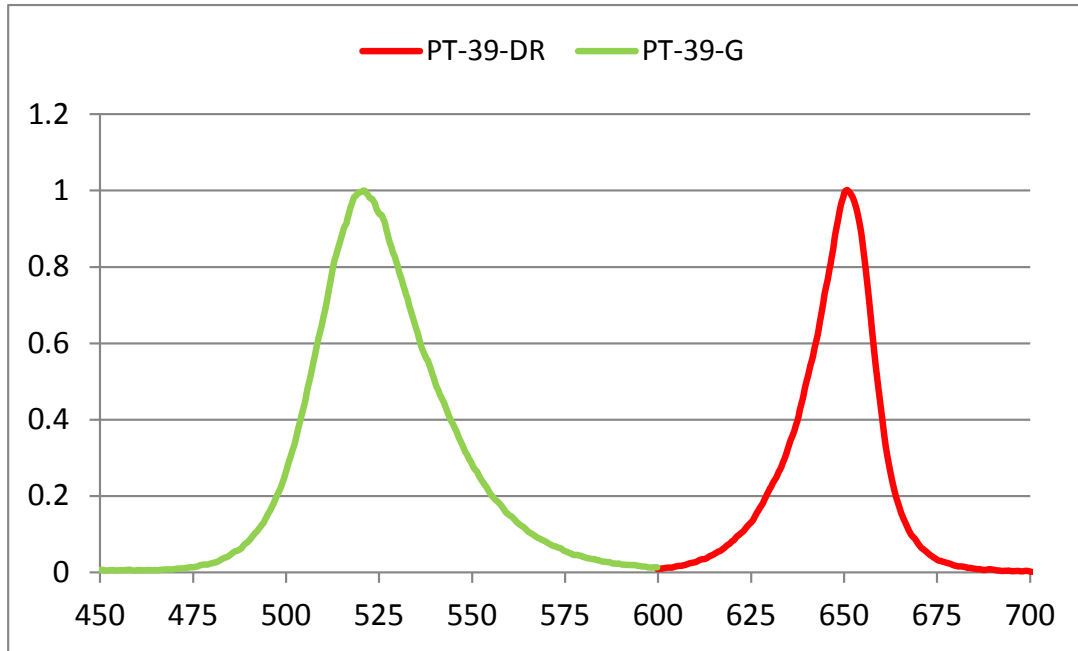

### Optical Spectrum (Typical)



### Angular Intensity Distribution (Typical)

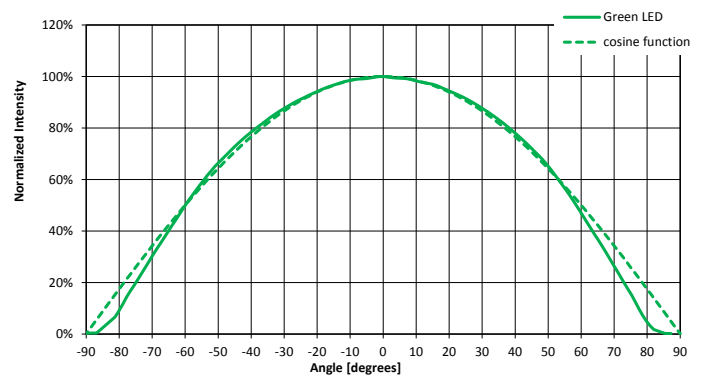
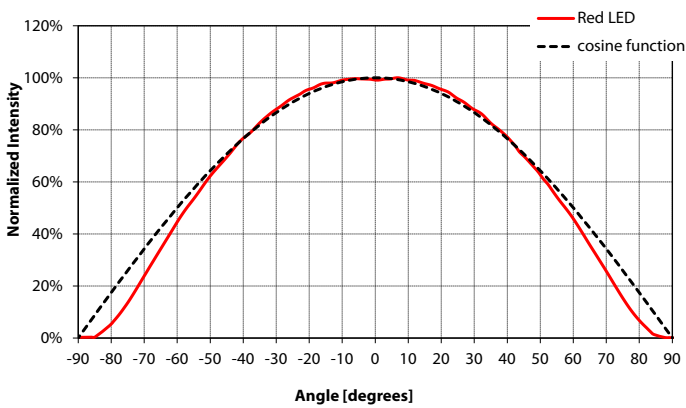

## Thermal Resistance

### Typical Thermal Resistance

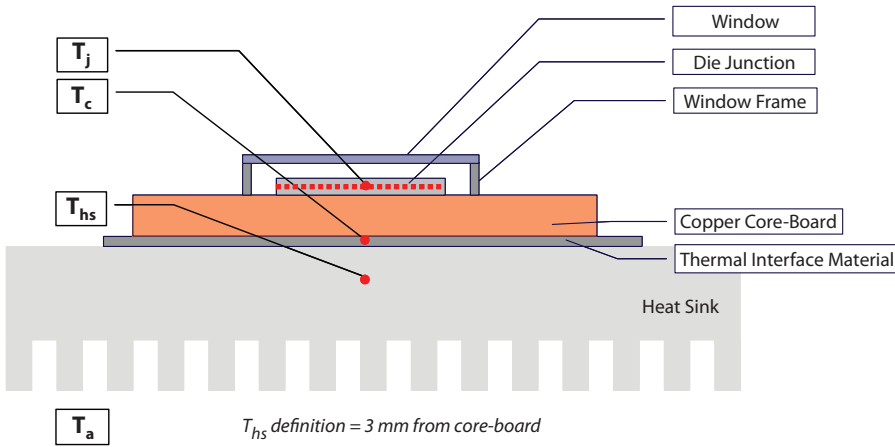

$R_{\theta j-b}^1$	1.0°C/W
$R_{\theta b-hs}^2$	0.2°C/W
$R_{\theta j-hs}^{1,2}$	1.2°C/W

Note 1: Thermal resistance values are based on modeled results correlated to measured  $R_{\theta j-hs}$  data using the wavelength shift method.

Note 2: Thermal Resistance is based on eGraf 1205 Thermal interface.

## Electrical Pinout

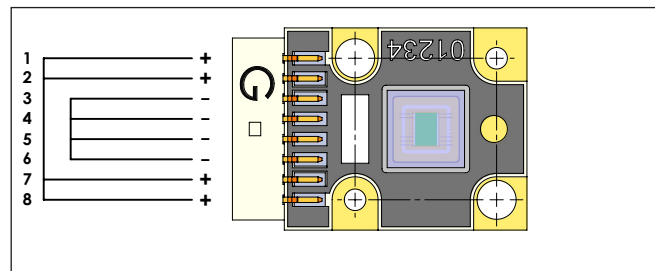

### Green and Deep Red Devices

### Mechanical Dimensions

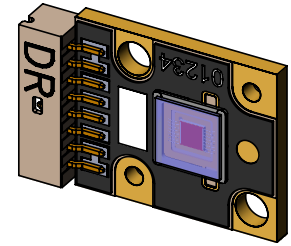
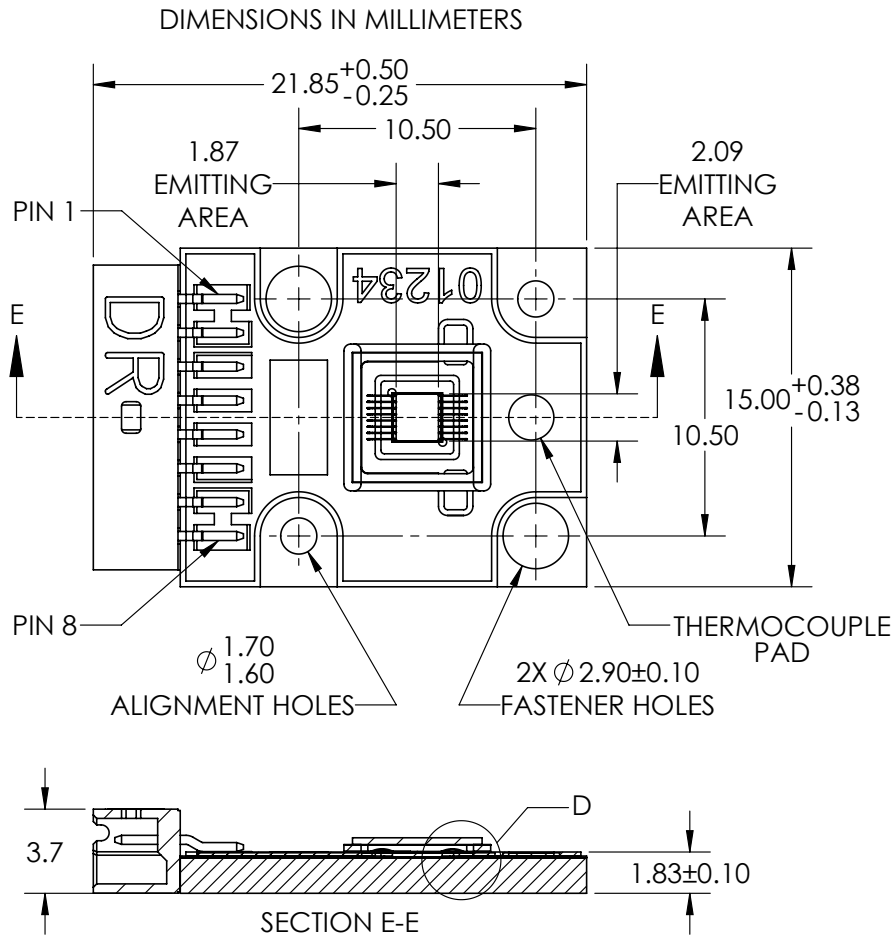

DEEP RED LED DEVICE

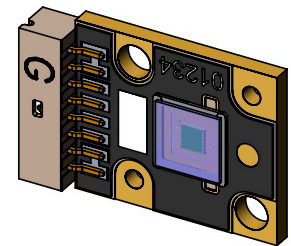

GREEN LED DEVICE

PIN ASSIGNMENTS		
LED COLOR	CATHODE (-)	ANODE (+)
DEEP RED	3,4,5,6	1,2,7,8
GREEN		

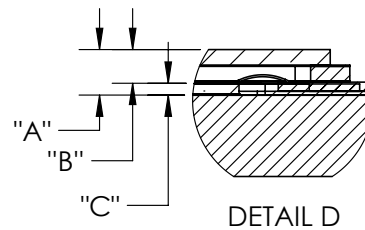

DIMENSION NAME	DESCRIPTION	NOMINAL DIMENSION	TOLERANCE
"A"	TOP OF METAL SUBSTRATE TO TOP OF WINDOW	0.88	±0.13
"B"	TOP OF DIE EMITTING AREA TO TOP OF WINDOW	0.65	±0.11
"C"	TOP OF METAL SUBSTRATE TO TOP OF DIE EMITTING AREA	0.23	±0.02

Notes:

- 1) Deep-Red and Green PT-39-L51, Big Chip LEDs are individually assembled into a common anode copper core-board with a footprint of 21.85mm x 15 mm.
- 2) Dimensions above are for information only. Please refer to the latest revision of the DWG-002140 package outline mechanical specifications.
- 3) Connector Information:  
Manufacturer: Tarng-Yu: Part # TU1512HNO-08-M5
- 4) PT-39-L51 Mating Connector Cable Assembly ordering part number (for evaluation purposes only): 960041

Ordering Part Number	Color	Description
PT-39-DR-L51-BD100	Deep Red	PT-39 -DR consisting of a 3.9 mm <sup>2</sup> LED, with a minimum power of 2.6W, a wavelength range from 645nm to 655nm, a connector and a copper-core PCB.
PT-39-G-L51-CD100	Green	PT-39 -G consisting of a 3.9 mm <sup>2</sup> LED, with a minimum power of 2.6W, a wavelength range from 510nm to 530nm, a connector and a copper-core PCB.

### History of Changes

Rev	Date	Description of Change
01	04/25/2016	Initial Release
02	04/13/2017	Updated max Vf specification from 5.0 to 5.5V and typical from 4.0 to 5.0V. Added min forward current = 200 mA.