



Chipsmall Limited consists of a professional team with an average of over 10 year of expertise in the distribution of electronic components. Based in Hongkong, we have already established firm and mutual-benefit business relationships with customers from,Europe,America and south Asia,supplying obsolete and hard-to-find components to meet their specific needs.

With the principle of "Quality Parts,Customers Priority,Honest Operation,and Considerate Service",our business mainly focus on the distribution of electronic components. Line cards we deal with include Microchip,ALPS,ROHM,Xilinx,Pulse,ON,Everlight and Freescale. Main products comprise IC,Modules,Potentiometer,IC Socket,Relay,Connector.Our parts cover such applications as commercial,industrial, and automotives areas.

We are looking forward to setting up business relationship with you and hope to provide you with the best service and solution. Let us make a better world for our industry!



Contact us

Tel: +86-755-8981 8866 Fax: +86-755-8427 6832

Email & Skype: info@chipsmall.com Web: www.chipsmall.com

Address: A1208, Overseas Decoration Building, #122 Zhenhua RD., Futian, Shenzhen, China



PT-40-TE LED™

Thermally Enhanced LED Projection Chipset

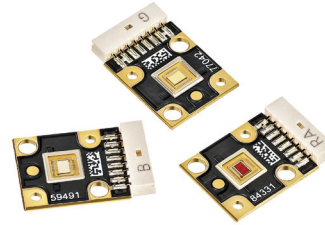

Table of Contents

| | |
|---|-----|
| Technology Overview | 2 |
| Understanding Luminus Test Specifications | 2 |
| Ordering Information | 3 |
| Flux /Power Bin Definition | 4 |
| Optical & Electrical Characteristics | 5-6 |
| Blue Flux Bin Ranges by Wavelength | 7 |
| Characterization Curves | 8 |
| Spectrum and Angular Intensity Distribution | 9 |
| Thermal Resistance and Electrical Pin Out | 10 |
| Mechanical Dimensions | 11 |
| Shipping Tray Outline | 12 |
| Packing and Shipping Specifications | 13 |
| History of Changes | 14 |

Features:

- Matched RGB Chipset with 2.4 mm x 1.6 mm (3.9 mm²) emitting area designed for LED projector applications
- Ultra low thermal resistance, copper-core PCB package
- Wide color gamut: Red-Amber 613 nm, Green 525 nm, Blue 460 nm typical dominant wavelength
- Single emitting area per color allows for collection with single lens for simplified optics
- LED mounted on MC-PCB for easier thermal and optical integration
- LED emitting area optimized and compatible with micro-display diagonal sizes ranging from 0.45" to 0.55"
- Environmentally friendly: RoHS and REACH compliant

Applications

- Specifically engineered for high brightness pocket-size, ultra portable front projectors, head-up projection displays and hybrid projectors
- Optimized for Micro-Display diagonal sizes ranging from 0.45" to 0.55"
- Suitable for DLP™ (0.45" WXGA), LCoS and HTPS /3LCD microdisplays

Technology Overview

Luminus LEDs™ benefit from a suite of innovations in the fields of chip technology, packaging and thermal management. These breakthroughs allow illumination engineers and system designers to achieve solutions that are high brightness and high efficiency.

Packaging Technology

Thermal management is critical in high power LED applications. With a thermal resistance from junction to case of 1.0°C/W , Luminus PT-40 LEDs can be driven at higher current densities while maintaining a low junction temperature, thereby resulting in brighter solutions and longer lifetimes.

Reliability

For high power operation, Luminus LEDs are one of the most reliable light sources in the world today. Luminus LEDs have passed a rigorous suite of environmental and mechanical stress tests, including mechanical shock, vibration, temperature cycling and humidity, and have been fully qualified for use in extreme high power and high current applications. With very low failure rates and median lifetimes that typically exceed 60,000 hours, Luminus LEDs are ready for even the most demanding applications. (Please refer to Luminus' Reliability application note for more information.)

Environmental Benefits

Luminus LEDs help reduce power consumption and the amount of hazardous waste entering the environment. All Luminus LED products manufactured by Luminus are RoHS and REACH compliant and free of hazardous materials, including lead and mercury.

Understanding Luminus LED Test Specifications

Every Luminus LED is extensively tested at rated current to ensure that it meets the high quality standards expected from Luminus products.

Testing of Luminus LEDs

Luminus core board products are typically measured in such a way that the characteristics reported agree with how the devices will actually perform when incorporated into a system. This measurement is accomplished by mounting the devices on a 40°C heat sink and allowing the device to reach thermal equilibrium while fully powered. Only after the device reaches equilibrium are the measurements taken. This method of measurement ensures that Luminus LEDs perform in the field just as they are specified.

Ordering Information

| Ordering Part Number ¹ | Color | Min Flux or Power Bin ² | Description |
|-----------------------------------|-----------|------------------------------------|--|
| PT-40-RAX-L55-MPH | Red-Amber | 2H | Red-Amber LED, consisting of a 3.9 mm ² Red-Amber LED chip and connector mounted on a copper-core PCB (note: reverse polarity pin-out). |
| PT-40-RAX-L55-MPJ | | 2J | |
| PT-40-G-L51-MPH | Green | 2H | Green LED, consisting of a 3.9 mm ² Green LED chip and connector mounted on a copper-core PCB. |
| PT-40-G-L51-MPJ | | 2J | |
| PT-40-B-L51-EPH | Blue | 2H | Blue LED, consisting of a 3.9 mm ² Blue LED chip and connector mounted on a copper-core PCB. |
| PT-40-B-L51-EPJ | | 2J | |

Note 1: Ordering part numbers represent bin kits (group of bins that are shippable for a given ordering part number)

Note 2: See Bin Kit and Flux / Power bin definitions on page 4

Ordering Part Number Nomenclature

XXX — 00 — XXXX — X00 — XXX

| Product Family | Chip Area | Color | Package Configuration | Bin Kit ¹ |
|-------------------------|-------------------------|---|---|-----------------------------------|
| PT: Metal Coreboard PCB | 40: 3.9 mm ² | RAX= Red -Amber (613nm, typ) G= Green B= Blue | L51: 21.85 mm x 15.0 mm (See Mechanical Drawing section) | See page 4 for bin kit definition |

Note 1: A Bin Kit represents a group of individual flux or power bins that are shippable for a given ordering part number. Individual flux bins are not orderable.

EXAMPLE:

PT-40-G-L51-MPH is comprised of Green Flux Bins 2H, 2J, 2K, 2L, 2M

PT-40 Bin Kit¹ and Flux Bin^{2,3,4} Definitions

Note: Please refer to ordering part number table on page 3 for Bin Kit availability

| Red -Amber Flux Bins | Bin 2H | Bin 2J | Bin 2K | Bin 2L | Bin 2M | | | |
|--------------------------------|-------------------------------------|-------------------------------------|-------------------------------------|-------------------------------------|-------------------------------------|-------------------------------------|--|--|
| Red -Amber Bin Flux Range (lm) | 800-860 | 860-925 | 925-990 | 990-1055 | 1055-1125 | | | |
| PT-40-RAX-L55-MPH | <input checked="" type="checkbox"/> | <input checked="" type="checkbox"/> | <input checked="" type="checkbox"/> | <input checked="" type="checkbox"/> | | | | |
| PT-40-RAX-L55-MPJ | | <input checked="" type="checkbox"/> | <input checked="" type="checkbox"/> | <input checked="" type="checkbox"/> | <input checked="" type="checkbox"/> | | | |
| Green Flux Bins | Bin 2H | Bin 2J | Bin 2K | Bin 2L | Bin 2M | Bin 2N | | |
| Green Bin Flux Range (lm) | 1450-1550 | 1550-1660 | 1660-1780 | 1780-1900 | 1900-2020 | 2020-2150 | | |
| PT-40-G-L51-MPH | <input checked="" type="checkbox"/> | <input checked="" type="checkbox"/> | <input checked="" type="checkbox"/> | <input checked="" type="checkbox"/> | <input checked="" type="checkbox"/> | | | |
| PT-40-G-L51-MPJ | | <input checked="" type="checkbox"/> | <input checked="" type="checkbox"/> | <input checked="" type="checkbox"/> | <input checked="" type="checkbox"/> | <input checked="" type="checkbox"/> | | |
| Blue Flux Bins | Bin 2H | Bin 2J | Bin 2K | Bin 2L | Bin 2M | Bin 2N | | |
| Blue Bin Flux Range (lm) | 280-300 | 300-320 | 320-345 | 345-370 | 370-400 | 400-430 | | |
| PT-40-B-L51-EPH | <input checked="" type="checkbox"/> | <input checked="" type="checkbox"/> | <input checked="" type="checkbox"/> | <input checked="" type="checkbox"/> | <input checked="" type="checkbox"/> | | | |
| PT-40-B-L51-EPJ | | <input checked="" type="checkbox"/> | <input checked="" type="checkbox"/> | <input checked="" type="checkbox"/> | <input checked="" type="checkbox"/> | <input checked="" type="checkbox"/> | | |

- Note 1: Bin Kits are defined by a group of flux or power bins. Only one flux bin will be shipped in each individual pack. A shipment will contain packs of different allowed flux bins for a particular ordering part number. Individual Flux or Power bins are not orderable.
- Note 2: PT-40 LEDs are tested for luminous flux at 9.8 A at 25% duty cycle for Red-Amber and Blue, and at 50% duty cycle for Green Devices. Devices are sorted and packed by flux bin. Not all flux bins are currently populated.
- Note 3: Luminus maintains a test measurement accuracy for LED flux and power of +/- 6%.
- Note 4: Blue Flux bin limits are defined at reference dominant wavelength of 462 nm. See table on page 7 for Blue bin limits at other dominant wavelengths.

Optical & Electrical Characteristics

| General Characteristics | | Symbol | Red -Amber Preliminary | Green Preliminary | Blue Preliminary | Unit |
|--|-----|-------------------|---------------------------|----------------------|---------------------|-----------------|
| Emitting Area | | | 3.9 | 3.9 | 3.9 | mm ² |
| Emitting Area Dimensions | | | 2.42 x 1.61 | 2.42 x 1.61 | 2.42 x 1.61 | mmxmm |
| Characteristics at Recommended Test Drive Current , I_f^{1,2} | | | | | | |
| Reference Duty Cycle ³ | | | 25 | 50 | 25 | % |
| Test Peak Drive Current ^{1,2,4} | typ | I _F | 9.8 | 9.8 | 9.8 | A |
| Peak Luminous Flux ^{1,2,5} | typ | Φ _v | 860 | 1750 | 300 | lm |
| Peak Radiometric Flux ^{1,2} | typ | Φ _r | 3.0 | 3.5 | 6.2 | W |
| Dominant Wavelength | min | λ _{dmin} | 609 | 516 | 450 | nm |
| | typ | λ _d | 613 | 525 | 460 | nm |
| | max | λ _{dmax} | 620 | 540 | 468 | nm |
| FWHM- Spectral bandwidth at 50% of Φ _r | typ | | 19 | 34 | 20 | nm |
| Chromaticity Coordinates ^{6,7} | typ | x | 0.675 | 0.167 | 0.147 | |
| | typ | y | 0.325 | 0.704 | 0.033 | |
| Forward Voltage | min | V _{Fmin} | 2.7 | 3.5 | 3.2 | V |
| | typ | V _F | 3.1 | 5.1 | 3.8 | V |
| | max | V _{Fmax} | 3.7 | 5.9 | 5.2 | V |
| Dynamic Resistance | typ | | 0.13 | 0.12 | 0.09 | Ω |
| Device Thermal Characteristics | | | | | | |
| Thermal Coefficient of Photometric Flux | typ | | -1 | -0.2 | ~0 | % / °C |
| Thermal Coefficient of Radiometric Flux | typ | | -0.7 | -0.2 | -0.2 | % / °C |
| Forward Voltage Temperature Coefficient | typ | | -2 | -4.7 | -3 | mV/ °C |

Note 1: All ratings are based on testing conditions with a constant heat sink temperature T_{hs} = 40° C. See Thermal Resistance section for T_{hs} definition.

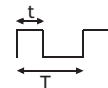
Note 2: Parameters rated at test duty cycle and Pulsed operation frequency f > 240 Hz; DC = $\frac{t}{T}$ 

Note 3: Duty Cycle used to specify device ratings under Pulsed operation. Big Chip LED devices can operate at duty cycles ranging from 1% to 100%. At higher duty cycles, drive current should be adjusted to maintain the junction temperature at desired levels to meet the application lifetime requirements.

Note 4: In pulsed operation, rise time from 10% to 90% of forward current should be larger than 0.5 microseconds.

Note 5: For Blue devices, total flux from emitting area at typical dominant wavelength. Refer to page 7 for brightness specifications at other wavelengths.

Note 6: CIE 1931 chromaticity diagram coordinates, normalized to X+Y+Z=1.

Note 7: For reference only.

Optical & Electrical Characteristics

Absolute Maximum Ratings (Preliminary)

| | Symbol | Red -Amber | Green | Blue | Unit |
|---|----------------------|------------|------------|------------|------|
| Absolute Minimum Current (CW or Pulsed) ¹ | | 200 | 200 | 200 | mA |
| Absolute Maximum Current (CW) ² | | 8.6 | 8.6 | 8.6 | A |
| Absolute Maximum Current (Pulsed) ^{2,3} (frequency > 240Hz, duty cycle <50%) | | 11.7 | 11.7 | 11.7 | A |
| Absolute Maximum Surge Current ^{2,3} (Frequency > 240 Hz, duty cycle =10%, t=1ms) | | 13.7 | 13.7 | 13.7 | A |
| Maximum Operating Junction Temperature ⁴ | T _{jmax,op} | 100 | 140 | 130 | °C |
| Absolute Maximum Junction Temperature ⁴ | T _{jmax} | 125 | 170 | 170 | °C |
| Storage Temperature Range | | -40 / +100 | -40 / +100 | -40 / +100 | °C |

Note 1: Product performance and lifetime data is specified at recommended forward drive currents. Sustained operation at or near absolute minimum currents may result in a reduction of device performance and device lifetime compared to recommended forward currents.

Note 2: Maximum forward drive current conditions for continuous operation are 8.6 A, CW (2.2 A/mm²), and 11.7 A, f>240 Hz, duty cycle <70% (3.0 A/mm²). Sustained operation above maximum currents is not recommended and will result in a reduction of device lifetime compared to specified maximum forward drive currents. Device lifetimes will depend on junction temperature (see Reliability Application Note, APN-001444 for product lifetimes as function of junction temperature). Please refer to lifetime de-rating curves (available from Luminus) for further information.

Note 3: In pulsed operation, rise time from 10 to 90% of forward current should be larger than 0.5 microseconds.

Note 4: Sustained operation at or above Maximum Operating Junction Temperature (T_{jmax}) will result in significant reduction in device lifetime.

Blue Bin Flux Ranges by Dominant Wavelength ^{1,2}

| DWL (nm) | Bin2H | | Bin 2J | | Bin 2K | | Bin 2L | | Bin 2M | | Bin 2N | |
|----------|----------|----------|----------|----------|----------|----------|----------|----------|----------|----------|----------|----------|
| | Min (lm) | Max (lm) | Min (lm) | Max (lm) | Min (lm) | Max (lm) | Min (lm) | Max (lm) | Min (lm) | Max (lm) | Min (lm) | Max (lm) |
| 450 | 137 | 147 | 147 | 156 | 156 | 169 | 169 | 181 | 181 | 196 | 196 | 210 |
| 451 | 149 | 159 | 159 | 170 | 170 | 183 | 183 | 197 | 197 | 213 | 213 | 229 |
| 452 | 161 | 172 | 172 | 184 | 184 | 198 | 198 | 212 | 212 | 230 | 230 | 247 |
| 453 | 173 | 185 | 185 | 197 | 197 | 213 | 213 | 228 | 228 | 247 | 247 | 265 |
| 454 | 185 | 198 | 198 | 211 | 211 | 227 | 227 | 244 | 244 | 264 | 264 | 283 |
| 455 | 197 | 211 | 211 | 225 | 225 | 242 | 242 | 260 | 260 | 281 | 281 | 302 |
| 456 | 208 | 223 | 223 | 238 | 238 | 257 | 257 | 275 | 275 | 298 | 298 | 320 |
| 457 | 220 | 236 | 236 | 252 | 252 | 272 | 272 | 291 | 291 | 315 | 315 | 338 |
| 458 | 232 | 249 | 249 | 265 | 265 | 286 | 286 | 307 | 307 | 332 | 332 | 357 |
| 459 | 244 | 262 | 262 | 279 | 279 | 301 | 301 | 323 | 323 | 349 | 349 | 375 |
| 460 | 256 | 274 | 274 | 293 | 293 | 316 | 316 | 338 | 338 | 366 | 366 | 393 |
| 461 | 268 | 287 | 287 | 306 | 306 | 330 | 330 | 354 | 354 | 383 | 383 | 412 |
| 462 | 280 | 300 | 300 | 320 | 320 | 345 | 345 | 370 | 370 | 400 | 400 | 430 |
| 463 | 292 | 313 | 313 | 334 | 334 | 360 | 360 | 386 | 386 | 417 | 417 | 448 |
| 464 | 304 | 326 | 326 | 347 | 347 | 374 | 374 | 402 | 402 | 434 | 434 | 467 |
| 465 | 316 | 338 | 338 | 361 | 361 | 389 | 389 | 417 | 417 | 451 | 451 | 485 |
| 466 | 328 | 351 | 351 | 375 | 375 | 404 | 404 | 433 | 433 | 468 | 468 | 503 |
| 467 | 340 | 364 | 364 | 388 | 388 | 418 | 418 | 449 | 449 | 485 | 485 | 522 |
| 468 | 352 | 377 | 377 | 402 | 402 | 433 | 433 | 465 | 465 | 502 | 502 | 540 |

Note 1: Flux Min, Max values are continuous as function of dominant wavelength values. For illustration purposes, flux Min and Max values are provided at discrete dominant wavelength values.

Note 2: Luminus maintains a test measurement accuracy for LED flux and power of +/- 6%.

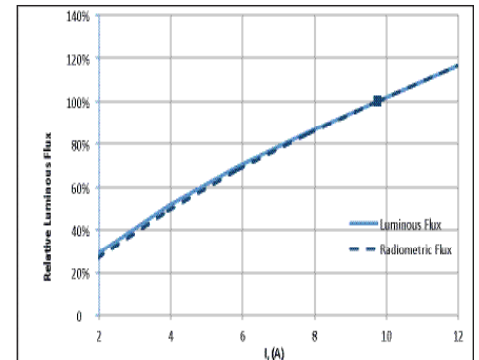
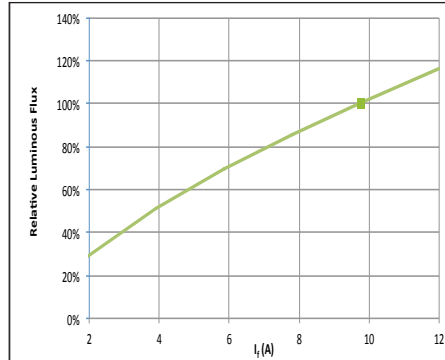
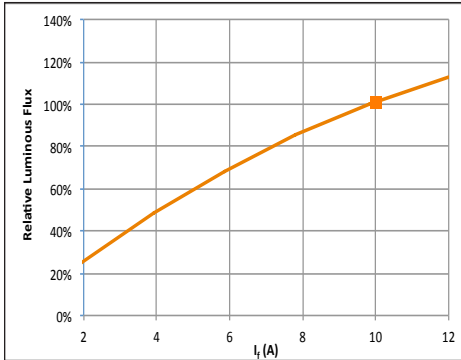
Normalized Luminous Flux variation with Forward Current: $\Phi_V(I_F) / \Phi_V(9.8\text{ A})$

See notes 1, 2 on page 9.

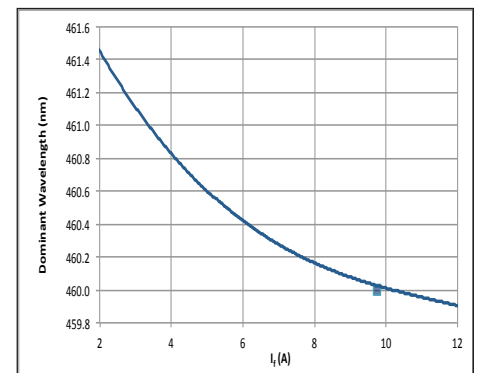
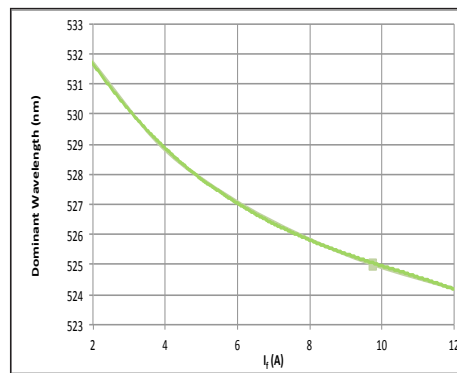
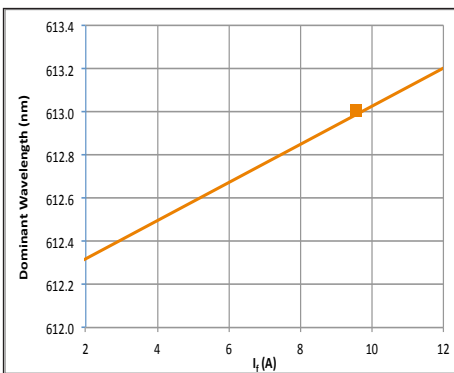
Dominant Wavelength variation with Forward Current - $\lambda_d = f(I_F)$ - Typical

See notes 1, 2 on page 9.

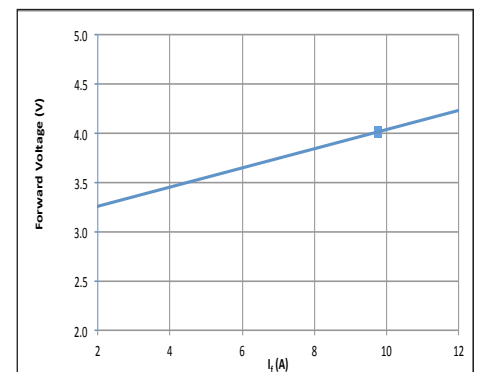
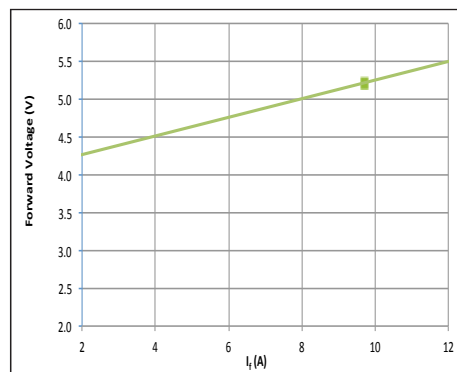
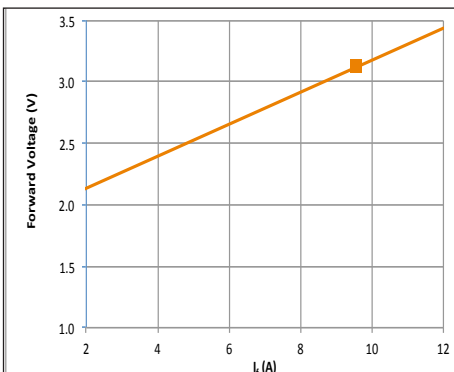
Forward Voltage variation with Drive Current - $V_F = f(I_F)$ - Typical

See notes 1, 2 on page 9.

Optical Spectrum (Typical)

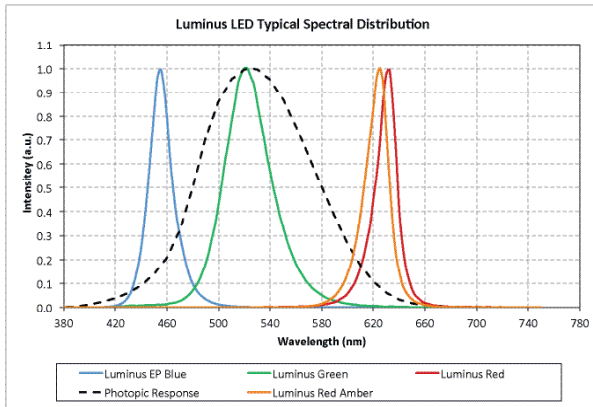

See notes 1, 3 on page 9.

Angular Intensity Distribution (Typical)

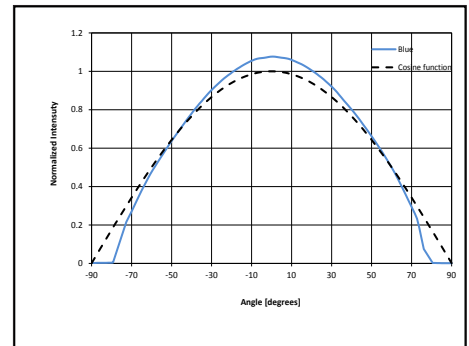
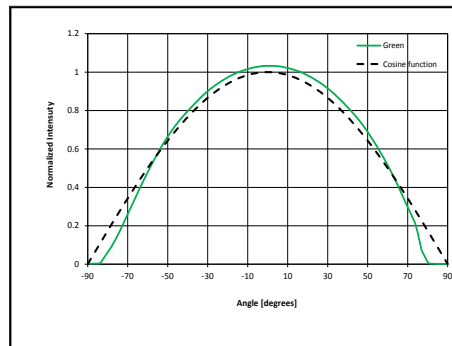
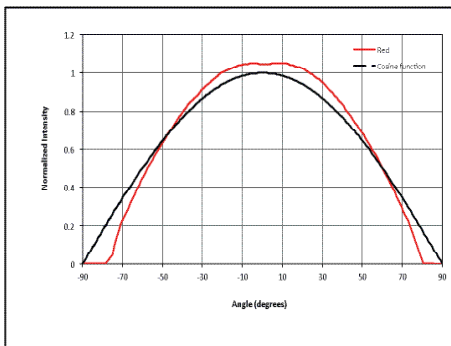

See note 4 on page 9.

- Note 1: For Pulsed operation, the reference R,G, and B duty cycles used are 25%, 50% and 25% respectively ($T_{hs}=40^{\circ}C$; Frequency =720 Hz).
- Note 2: Square on curves indicates device operating current point (9.8A) under reference conditions listed in the Optical and Electrical Characteristics table.
- Note 3: Typical spectrum at recommended peak drive current . Please contact Luminus to obtain data in Excel format.
- Note 4: Curves (solid) represent the angular radiation pattern of a typical (Red, Green or Blue) device. Discontinuous line represents cosine function. For any specific device, slight variations may be expected.

Thermal Resistance

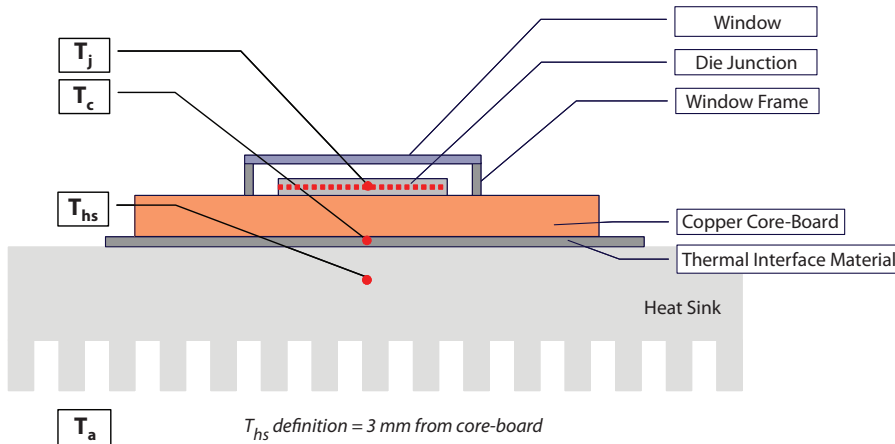

Typical Thermal Resistance

| | |
|-------------------------|----------|
| $R_{\theta j-b}^1$ | 1.0 °C/W |
| $R_{\theta b-hs}^2$ | 0.2 °C/W |
| $R_{\theta j-hs}^{1,2}$ | 1.2 °C/W |

Note 1: Thermal resistance values are preliminary and are based on modeled results correlated to measured $R_{\theta j-hs}$ data using the wavelength shift method. Verification of compliance with the recent releases of JEDEC Standards JESD51-14 and JESD51-5x series is pending.

Note 2: Thermal Resistance is based on eGraf 1205 Thermal interface.

Electrical Pinout

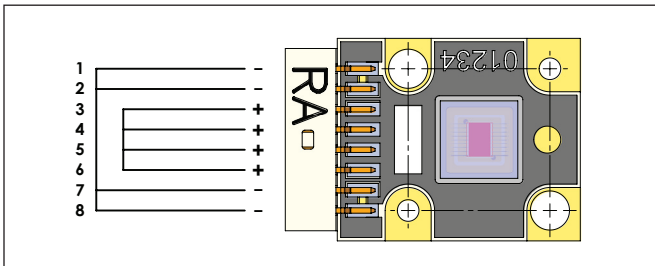

Red Devices

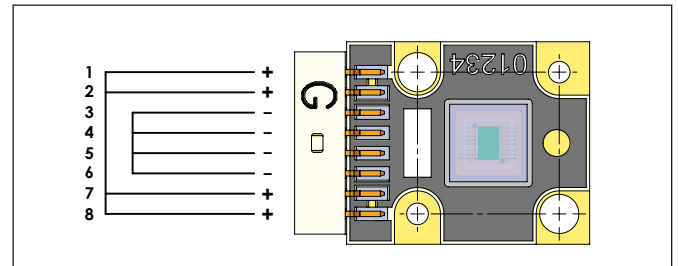

Green and Blue Devices

Mechanical Dimensions

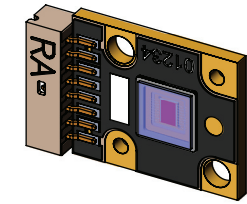
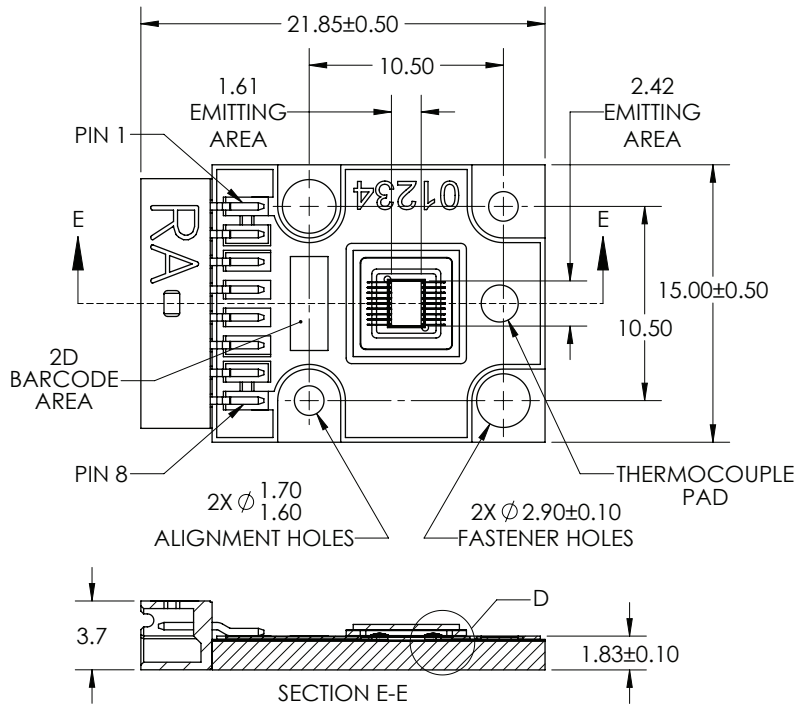

RED AMBER LED DEVICE

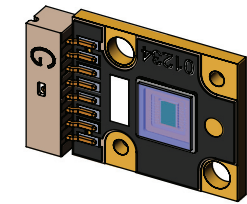

GREEN LED DEVICE

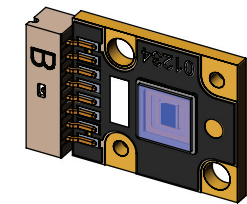

BLUE LED DEVICE

| PIN ASSIGNMENTS | | |
|-----------------|-------------|-----------|
| LED COLOR | CATHODE (-) | ANODE (+) |
| BLUE | 3,4,5,6 | 1,2,7,8 |
| GREEN | 1,2,7,8 | 3,4,5,6 |
| RED AMBER | 1,2,7,8 | 3,4,5,6 |

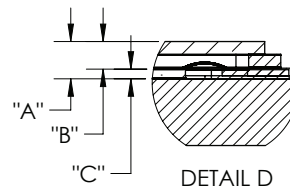

| DIMENSION NAME | DESCRIPTION | NOMINAL DIMENSION | TOLERANCE |
|----------------|--|-------------------|-----------|
| "A" | TOP OF METAL SUBSTRATE TO TOP OF WINDOW | 0.88 | ±0.13 |
| "B" | TOP OF EMITTING AREA TO TOP OF WINDOW | 0.65 | ±0.11 |
| "C" | TOP OF METAL SUBSTRATE TO TOP OF DIE EMITTING AREA | 0.23 | ±0.02 |

DWG-002102

Notes:

- Whereas PT40 Green and Blue LEDs are packaged in a common anode copper core board, PT40 Red LEDs are packaged in a common cathode copper core board, with a footprint of 21.85mm x 15 mm.
- Dimensions above are for information only. Please refer to the latest revision of the DWG- 002102 package outline mechanical specifications.
- Connector Information:
 Manufacturer: Tarng-Yu
 Part # TU1512WNR-08SI-GO-M8-NL-A
- Mating female connector information:
 Manufacturer: Tarng-Yu
 Part # TU1512HNO-08-M5; contact terminal part # TU1512TPO-GO
- PT-40 Mating Connector Cable Assembly ordering part number (small quantity orders for evaluation purposes only): 960041

Shipping Tray Outline

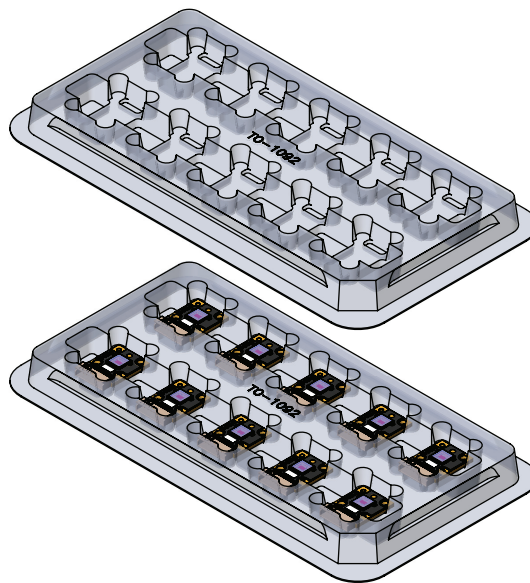
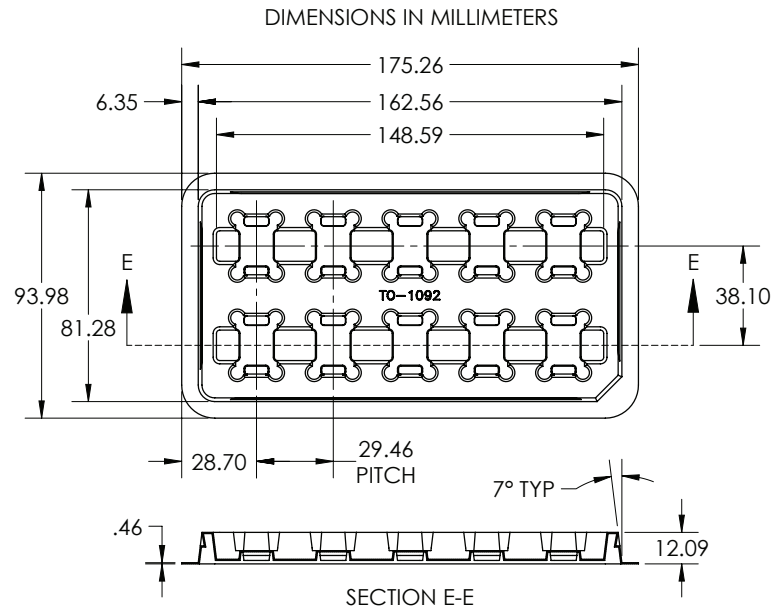

For detailed drawing of shipping tray, please refer to document TO-1092, available upon request.

Packing and Shipping Specifications

Packing Specification







| Packing Configuration | Qty /Pack | Pack Dimensions (L x W x H, mm) | Gross Weight (kg) |
|---|-----------|------------------------------------|-------------------|
| Stack of 5 trays with 10 devices per tray Each pack is enclosed in ESD bag | 50 | 18 x 10 x 4 | 0.29 |

Product Label Specification

Label Fields:

- 6-8 digit Box number (for Luminus internal use)
- Luminus ordering part number
- Quantity of devices in pack
- Part number revision (for Luminus internal use)
- Customer's part number (optional)
- Flux Bin
- 2D Bar code



| | | | |
|---|--|---|--|
| <p>BP-012345  Box number</p> <p>PT-40-RAX-L55-MPK  Luminus part number</p> <p>12345678  Customer part number</p> <p>2K  Bin</p> | <p>Qty: 50 </p> <p>Rev 01 </p> |  | for traceability peel off label and attach |
|---|--|---|--|

RoHS Compliant

Sample label –for illustration only

Shipping Box

| Shipping Box | Quantity | Material | Dimensions (L x W x H, mm) |
|--------------|-------------|----------|-------------------------------|
| Carton Box | 1 -20 packs | S4651 | 560 x 560 x 200 |

History of Changes

| Revision | Date | Description of Change |
|----------|----------|--|
| 01 | 11/29/12 | Preliminary Datasheet |
| 02 | 03/08/13 | Update ordering part numbers and characterization curves |
| 03 | 4/15/14 | Update t.b.d items on Rev 02 datasheet |

The products, their specifications and other information appearing in this document are subject to change by Luminus Devices without notice. Luminus Devices assumes no liability for errors that may appear in this document, and no liability otherwise arising from the application or use of the product or information contained herein. None of the information provided herein should be considered to be a representation of the fitness or suitability of the product for any particular application or as any other form of warranty. Luminus Devices' product warranties are limited to only such warranties as accompany a purchase contract or purchase order for such products. Nothing herein is to be construed as constituting an additional warranty. No information contained in this publication may be considered as a waiver by Luminus Devices of any intellectual property rights that Luminus Devices may have in such information. Big Chip LEDs™ is a registered trademark of Luminus Devices, Inc., all rights reserved.

This product is protected by U.S. Patents 6,831,302; 7,074,631; 7,083,993; 7,084,434; 7,098,589; 7,105,861; 7,138,666; 7,166,870; 7,166,871; 7,170,100; 7,196,354; 7,211,831; 7,262,550; 7,274,043; 7,301,271; 7,341,880; 7,344,903; 7,345,416; 7,348,603; 7,388,233; 7,391,059 Patents Pending in the U.S. and other countries.