



Chipsmall Limited consists of a professional team with an average of over 10 year of expertise in the distribution of electronic components. Based in Hongkong, we have already established firm and mutual-benefit business relationships with customers from,Europe,America and south Asia,supplying obsolete and hard-to-find components to meet their specific needs.

With the principle of “Quality Parts,Customers Priority,Honest Operation,and Considerate Service”,our business mainly focus on the distribution of electronic components. Line cards we deal with include Microchip,ALPS,ROHM,Xilinx,Pulse,ON,Everlight and Freescale. Main products comprise IC,Modules,Potentiometer,IC Socket,Relay,Connector.Our parts cover such applications as commercial,industrial, and automotives areas.

We are looking forward to setting up business relationship with you and hope to provide you with the best service and solution. Let us make a better world for our industry!



Contact us

Tel: +86-755-8981 8866 Fax: +86-755-8427 6832

Email & Skype: info@chipsmall.com Web: www.chipsmall.com

Address: A1208, Overseas Decoration Building, #122 Zhenhua RD., Futian, Shenzhen, China



RX SERIES

Related Information

- General terms and conditions..... F-7
- Sensor selection guide..... P.271~
- Glossary of terms..... P.1455~
- General precautions..... P.1458~

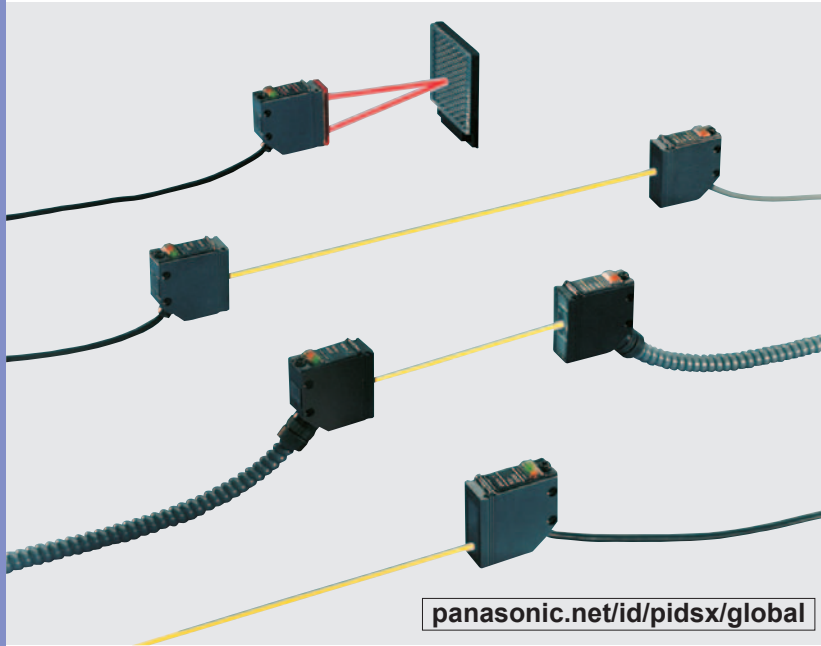

panasonic.net/id/pidsx/global



Sturdy photoelectric sensor made of die-cast zinc alloy

Robust

The enclosure is robust as it is made of die-cast zinc alloy.

VARIETIES

Standard type

RX

Wide variety

Thru-beam type

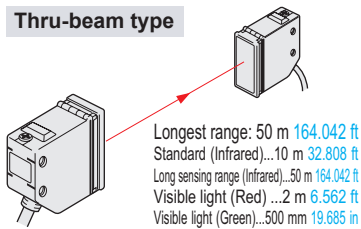

Diffuse reflective type

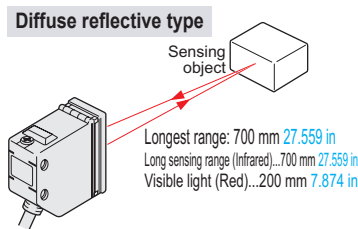

Retroreflective type

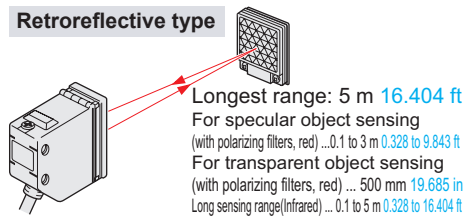

DC 2-wire type

RX2

Wiring reduced by 1/3

Wiring can be completed by using only two, instead of three wires.

Power supply cost: reduced to 1/30 or less

Current consumption: 1 mA or less
 An additional power supply for the sensors is not required.

Heavy duty type

RX4

Durable against oil

This sensor can be used in a harsh environment.

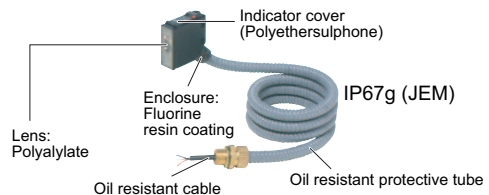

MAINTENANCE

Test input (emission halt input)

Convenient for operation check before start-up. (Excluding RX2 types)

FUNCTIONS

Automatic interference prevention function **Retroreflective / diffuse reflective types**

Two sensors can be mounted side by side because of the automatic interference prevention function. (Excluding RX2 types)

There is no problem even if the beam of the adjoining sensor is incident.

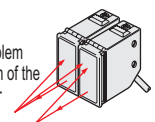

- Selection Guide
- Amplifier Built-in
- Power Supply Built-in
- Amplifier-separated

- CX-400
- CY-100
- EX-10
- EX-20
- EX-30
- EX-40
- CX-440
- EQ-30
- EQ-500
- MQ-W
- RX-LS200
- RX**
- RT-610

APPLICATIONS

Detecting passage of engines

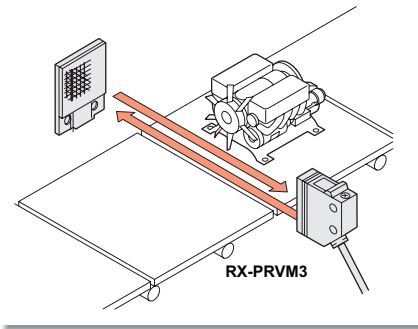

Confirming car position at parking garage

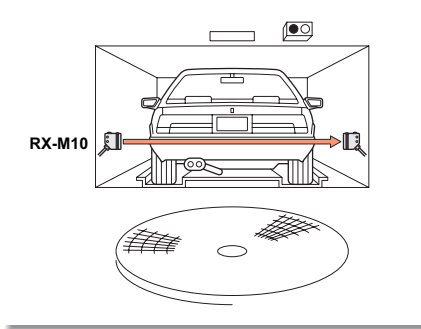

Sensing machine tools

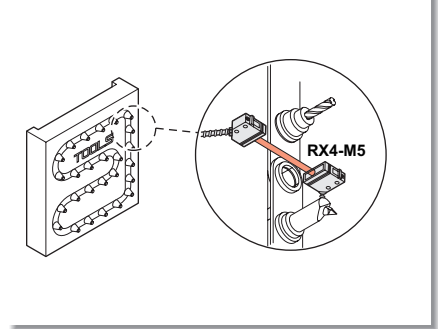

FIBER SENSORS

LASER SENSORS

PHOTO-ELECTRIC SENSORS

MICRO PHOTO-ELECTRIC SENSORS

AREA SENSORS

LIGHT CURTAINS / SAFETY COMPONENTS

PRESSURE / FLOW SENSORS

INDUCTIVE PROXIMITY SENSORS

PARTICULAR USE SENSORS

SENSOR OPTIONS

SAVE WIRE SAVING UNITS

MEASUREMENT SENSORS

STATIC ELECTRICITY PREVENTION DEVICES

LASER MARKERS

PLC

HUMAN MACHINE INTERFACES

ENERGY CONSUMPTION VISUALIZATION COMPONENTS

FA COMPONENTS

MACHINE VISION SYSTEMS

UV CURING SYSTEMS

Selection Guide

Amplifier Built-in

Power Supply Built-in

Amplifier-separated

CX-400

CY-100

EX-10

EX-20

EX-30

EX-40

CX-440

EQ-30

EQ-500

MQ-W

RX-LS200

RX

RT-610

ORDER GUIDE

Type		Appearance	Sensing range	Model No. (Note 2)	Output	
RX (Standard type)	Thru-beam	Infrared	10 m 32.808 ft	RX-M10	NPN open-collector transistor	
			Long sensing range	50 m 164.062 ft		RX-M50
			For mark sensing	Red		2 m 6.562 ft
	Green	500 mm 19.685 in		RX-500G		
	Retroreflective	Red (with polarizing filters)	0.1 to 3 m 0.328 to 9.843 ft (Note 1)	RX-PRVM3		
		Infrared (long sensing range)	0.1 to 5 m 0.328 to 16.404 ft (Note 1)	RX-RVM5		
Diffuse reflective	Infrared	700 mm 27.559 in	RX-D700			
	Red	200 mm 7.874 in	RX-D200R			
RX2 (DC 2-wire type)	Thru-beam	Infrared	5 m 16.404 ft	RX2-M5	Non contact DC 2-wire type	
	Retroreflective	Red (with polarizing filters)	0.1 to 2 m 0.328 to 6.562 ft (Note 1)	RX2-PRVM2		
	Diffuse reflective	Infrared	300 mm 11.811 in	RX2-D300		
RX4 (Heavy duty type)	Thru-beam	Infrared	2 m 6.562 ft cable length	RX4-M5	NPN open-collector transistor	
			3 m 9.843 ft cable length			5 m 16.404 ft
			5 m 16.404 ft cable length			

Notes: 1) The sensing range of the retroreflective type sensor is specified for the **RF-230** reflector. Further, the sensing range of **RX-PRVM3**, **RX-RVM5** and **RX2-PRVM2** is the possible setting range for the reflector. The sensor can detect an object less than 0.1 m 0.328 ft away.

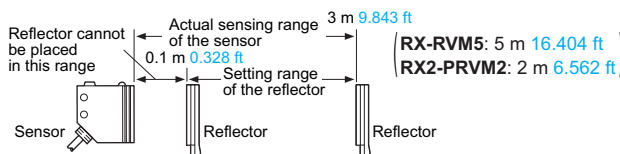

2) The model No. with "P" shown on the label affixed to the thru-beam type sensor is the emitter, "D" shown on the label is the receiver.

- FIBER SENSORS
- LASER SENSORS
- PHOTO-ELECTRIC SENSORS
- MICRO PHOTO-ELECTRIC SENSORS
- AREA SENSORS
- LIGHT CURTAINS/ SAFETY COMPONENTS
- PRESSURE / FLOW SENSORS
- INDUCTIVE PROXIMITY SENSORS
- PARTICULAR USE SENSORS
- SENSOR OPTIONS
- SIMPLE WIRE-SAVING UNITS
- WIRE-SAVING SYSTEMS
- MEASURE- MENT SENSORS
- STATIC ELECTRICITY PREVENTION DEVICES
- LASER MARKERS
- PLC
- HUMAN MACHINE INTERFACES
- ENERGY CONSUMPTION VISUALIZATION COMPONENTS
- FA COMPONENTS
- MACHINE VISION SYSTEMS
- UV CURING SYSTEMS

ORDER GUIDE

5 m 16.404 ft cable length type

5m 16.404 ft cable length type (standard: 2m 6.562 ft) is also available for **RX** and **RX2** types. (excluding **RX-500G**)
 When ordering this type, suffix “-C5” to the model No.
 (e.g.) 5 m 16.404 ft cable length type of **RX-M10** is “**RX-M10-C5**”.

Accessories

- **MS-RX-1** (Sensor mounting bracket)
- **MS-RX-2** (Sensor mounting bracket)
- **PT-RX4-1** (Oil resistant protective tube 1 m 3.281 ft long)
- **PT-RX4-2** (Oil resistant protective tube 2 m 6.562 ft long)
- **PT-RX4-4** (Oil resistant protective tube 4 m 13.123 ft long)
- **RF-230** (Reflector)

• MS-RX-1

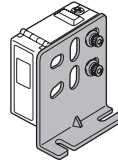

Two M4 (length 16 mm 0.630 in) hexagon-socket-head bolts are attached

• MS-RX-2

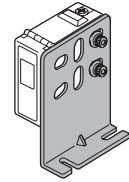

Two M4 (length 16 mm 0.630 in) hexagon-socket-head bolts are attached

• PT-RX4-□

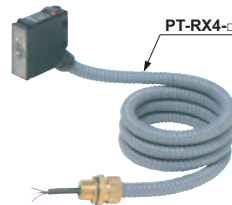

• RF-230

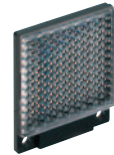

- Selection Guide
- Amplifier Built-in
- Power Supply Built-in
- Amplifier-separated

- CX-400
- CY-100
- EX-10
- EX-20
- EX-30
- EX-40
- CX-440
- EQ-30
- EQ-500
- MQ-W
- RX-LS200
- RX**
- RT-610

OPTIONS

Designation	Model No.	Description	
Slit mask (For RX-M10 and RX2-M5 only)	OS-RX-05×5 (Slit size 0.5 × 5 mm) 0.020 × 0.197 in	Slit on emitter <ul style="list-style-type: none"> Sensing range: 2.7 m 8.858 ft [RX-M10] 1.4 m 4.593 ft [RX2-M5] Min. sensing object: ø8 mm ø0.315 in 	
		Slit on receiver <ul style="list-style-type: none"> Sensing range: 1.9 m 6.234 ft [RX-M10] 1 m 3.281 ft [RX2-M5] Min. sensing object: ø6 mm ø0.236 in 	
	OS-RX-5×05 (Slit size 5 × 0.5 mm) 0.197 × 0.020 in	Slit on both sides <ul style="list-style-type: none"> Sensing range: 0.4 m 1.312 ft [RX-M10] 0.2 m 0.656 ft [RX2-M5] Min. sensing object: 0.5 × 5 mm 0.020 × 0.197 in 	
		Slit on emitter <ul style="list-style-type: none"> Sensing range: 3.8 m 12.467 ft [RX-M10] 1.9 m 6.234 ft [RX2-M5] Min. sensing object: ø8 mm ø0.315 in 	
	OS-RX-1×5 (Slit size 1 × 5 mm) 0.039 × 0.197 in	Slit on receiver <ul style="list-style-type: none"> Sensing range: 2.8 m 9.186 ft [RX-M10] 1.4 m 4.593 ft [RX2-M5] Min. sensing object: ø6 mm ø0.236 in 	
		Slit on both sides <ul style="list-style-type: none"> Sensing range: 0.8 m 2.625 ft [RX-M10] 0.4 m 1.312 ft [RX2-M5] Min. sensing object: 1 × 5 mm 0.039 × 0.197 in 	
	OS-RX-5×1 (Slit size 5 × 1 mm) 0.197 × 0.039 in	Slit on emitter <ul style="list-style-type: none"> Sensing range: 7 m 22.966 ft [RX-M10] 3.5 m 11.483 ft [RX2-M5] Min. sensing object: ø8 mm ø0.315 in 	
		Slit on receiver <ul style="list-style-type: none"> Sensing range: 4.9 m 16.076 ft [RX-M10] 2.5 m 8.202 ft [RX2-M5] Min. sensing object: ø6 mm ø0.236 in 	
	OS-RX-3×5 (Slit size 3 × 5 mm) 0.118 × 0.197 in	Slit on both sides <ul style="list-style-type: none"> Sensing range: 2.6 m 8.530 ft [RX-M10] 1.3 m 4.265 ft [RX2-M5] Min. sensing object: 3 × 5 mm 0.118 × 0.197 in 	
		Slit on emitter <ul style="list-style-type: none"> Sensing range: 0.2 to 1.5 m 0.656 to 4.921 ft [RX-RVM5] 0.4 to 1 m 1.312 to 3.281 ft [RX-PRVM3] Min. sensing object: ø30 mm ø1.181 in 	
	Reflector (For retroreflective type sensor only) (Note 1)	RF-210	<ul style="list-style-type: none"> Sensing range: 0.1 to 3.8 m 0.328 to 12.467 ft [RX-RVM5] 0.1 to 2 m 0.328 to 6.562 ft [RX-PRVM3] 0.1 to 1.3 m 0.328 to 4.265 ft [RX2-PRVM2] Min. sensing object: ø35 mm ø1.378 in
		RF-220	<ul style="list-style-type: none"> Sensing range: 0.2 to 1.5 m 0.656 to 4.921 ft [RX-RVM5] 0.4 to 1 m 1.312 to 3.281 ft [RX-PRVM3] Min. sensing object: ø30 mm ø1.181 in
Reflector mounting bracket (Note 1)	MS-RF21-1	Protective mounting bracket for RF-210 It protects the reflector from damage and maintains alignment.	
	MS-RF22	For RF-220	
	MS-RF23	For RF-230	
Reflective tape (For RX-RVM5) only	RF-T110	This tape can be used in place of the reflector by cutting it to a suitable size. <ul style="list-style-type: none"> Size: 100 × 100 mm 3.937 × 3.937 in Sensing range: 3 m 9.843 ft (at 50 × 50 mm 1.969 × 1.969 in) (There may be a slight variation depending on the product.) 	
Protective tube	PT-RX500	Cable is protected from external forces. It does not rust as it is made of stainless steel.	
	PT-RX1000		
Sensor checker	CHX-SC2 (Note 2)	It is useful for beam alignment of thru-beam type sensors. The optimum receiver position is given by indicators, as well as an audio signal.	

Notes: 1) Refer to **CX-400** series pages (p.301~) for dimensions of the reflector or the reflector mounting bracket.
2) Refer to p.980 for details of the sensor checker **CHX-SC2**.

Slit mask

- **OS-RX-□**
Fitted on the front face of the sensor with one-touch.

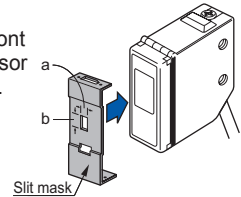

*Slit size
OS-RX-1×5
ã ã

Reflector

- **RF-210**
- **RF-220**



Reflector mounting bracket

- **MS-RF21-1**
- **MS-RF22**
- **MS-RF23**

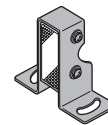

Two M3 (length 12 mm **0.472 in**) screws with washers are attached.

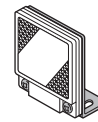

Two M3 (length 8 mm **0.315 in**) screws with washers are attached.

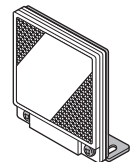

Two M4 (length 10 mm **0.394 in**) screws with washers are attached.

Protective tube

- **PT-RX500**
- **PT-RX1000**

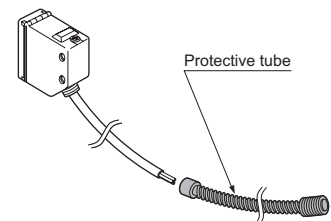

Sensor checker

- **CHX-SC2**

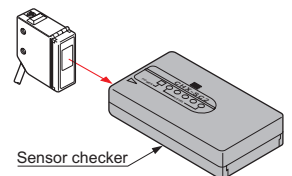

FIBER SENSORS

LASER SENSORS

PHOTO-ELECTRIC SENSORS

MICRO PHOTO-ELECTRIC SENSORS

AREA SENSORS

LIGHT CURTAINS / SAFETY COMPONENTS

PRESSURE / FLOW SENSORS

INDUCTIVE PROXIMITY SENSORS

PARTICULAR USE SENSORS

SENSOR OPTIONS

SMILE WIRE-SAVING UNITS

WIRE-SAVING SYSTEMS

MEASUREMENT SENSORS

STATIC ELECTRICITY PREVENTION DEVICES

LASER MARKERS

PLC

HUMAN MACHINE INTERFACES

ENERGY CONSUMPTION VISUALIZATION COMPONENTS

FA COMPONENTS

MACHINE VISION SYSTEMS

UV CURING SYSTEMS

Selection Guide

Amplifier Built-in

Power Supply Built-in

Amplifier-separated

CX-400

CY-100

EX-10

EX-20

EX-30

EX-40

CX-440

EQ-30

EQ-500

MQ-W

RX-LS200

RX

RT-610

SPECIFICATIONS

Standard type

Item	Model No.	Thru-beam				Retroreflective		Diffuse reflective	
		Infrared		Red	Green	Red (with polarizing filters)	Infrared (Long sensing range)	Infrared	Red
		Long sensing range							
Sensing range		RX-M10	RX-M50	RX-M2R	RX-500G	RX-PRVM3	RX-RVM5	RX-D700	RX-D200R
		10 m 32.808 ft	50 m 164.042 ft	2 m 6.562 ft	500 mm 19.685 in	0.1 to 3 m 0.328 to 9.843 ft (Note 2)	0.1 to 5 m 0.328 to 16.404 ft (Note 2)	700 mm 27.559 in (Note 3)	200 mm 7.874 in (Note 3)
Sensing object		ø10 mm 0.394 in or more opaque object (Note 4)				ø50 mm ø1.969 in or more opaque, translucent or specular object (Note 2, 5)	ø50 mm ø1.969 in or more opaque, or translucent object (Note 2, 5)	Opaque, translucent or transparent object (Note 5)	
Hysteresis		—————				—————		15 % or less of operation distance (Note 3)	
Repeatability (perpendicular to sensing axis)		0.5 mm 0.020 in or less				1 mm 0.039 in or less		0.5 mm 0.020 in or less	
Supply voltage		12 to 24 V DC ±10 %				Ripple P-P 10 % or less			
Current consumption		Emitter: 20 mA or less (RX-M50 : 25 mA or less), Receiver: 25 mA or less				40 mA or less			
Sensing output		NPN open-collector transistor <ul style="list-style-type: none"> • Maximum sink current: 100 mA • Applied voltage: 30 V DC or less (between sensing output and 0 V) • Residual voltage: 2 V or less (at 100 mA sink current) 1 V or less (at 16 mA sink current) 							
Utilization category		DC-12 or DC-13							
Output operation		Switchable either Light-ON or Dark-ON							
Short-circuit protection		Incorporated							
Self-diagnosis output		NPN open-collector transistor <ul style="list-style-type: none"> • Maximum sink current: 50 mA • Applied voltage: 30 V DC or less (between self-diagnosis output and 0 V) • Residual voltage: 1.5 V or less (at 50 mA sink current) 1 V or less (at 16 mA sink current) 							
Output operation		ON under unstable sensing condition							
Short-circuit protection		—————							
Response time		1 ms or less							
Test input (emission halt) function		Incorporated							
Operation indicator		Red LED (lights up when the sensing output is ON)							
Stability indicator		Green LED (lights up under stable light received condition or stable dark condition)							
Emitting indicator		Red LED (lights up during beam emission)				—————			
Sensitivity adjuster		Continuously variable adjuster							
Automatic interference prevention function		—————				Incorporated (Two units of sensors can be mounted close together.)			
Environmental resistance	Pollution degree	3 (Industrial environment)							
	Protection	IP67 (IEC)							
	Ambient temperature	-25 to +60 °C -13 to +140 °F (No dew condensation or icing allowed), Storage: -30 to +70 °C -22 to +158 °F							
	Ambient humidity	35 to 85 % RH, Storage: 35 to 85 % RH							
	Ambient illuminance	Incandescent light: 3,500 lx at the light-receiving face							
	EMC	EN 60947-5-2							
	Voltage withstandability	1,000 V AC for one min. between all supply terminals connected together and enclosure							
	Insulation resistance	20 MΩ, or more, with 250 V DC megger between all supply terminals connected together and enclosure							
Vibration resistance	10 to 500 Hz frequency, 1.5 mm 0.059 in amplitude (10 G max.) in X, Y and Z directions for two hours each								
Shock resistance	500 m/s ² acceleration (50 G approx.) in X, Y and Z directions for three times each								
Emitting element (modulated)		Infrared LED	Red LED	Green LED	Red LED	Infrared LED	Red LED		
	Peak emission wavelength	880 nm 0.035 mil	660 nm 0.026 mil	570 nm 0.022 mil	680 nm 0.027 mil	880 nm 0.035 mil	680 nm 0.027 mil		
Material		Enclosure: Die-cast zinc alloy, Indicator cover: Polyethersulphone, Lens: Polycarbonate (Retroreflective type: Acrylic)							
Cable		Emitter: 0.15 mm ² 3-core oil, heat and cold resistant cabtyre cable, 2 m 6.562 ft long Receiver: 0.15 mm ² 4-core oil, heat and cold resistant cabtyre cable, 2 m 6.562 ft long				0.15 mm ² 5-core oil, heat and cold resistant cabtyre cable, 2 m 6.562 ft long			
Cable extension		Extension up to total 100 m 328.084 ft is possible with 0.3 mm ² , or more, cable (thru-beam type: both emitter and receiver).							
Net weight		Emitter: 70 g approx. (RX-M50 : 75 g approx.) Receiver: 70 g approx. (RX-M50 : 75 g approx.)				75 g approx.			
Accessories		MS-RX-1 (Sensor mounting bracket): 1 set for emitter and receiver Adjusting screwdriver: 1 pc.				MS-RX-1 (Sensor mounting bracket): 1 set RF-230 (Reflector): 1 pc. Adjusting screwdriver: 1 pc.		MS-RX-1 (Sensor mounting bracket): 1 set Adjusting screwdriver: 1 pc.	

Notes: 1) Where measurement conditions have not been specified precisely, the conditions used were an ambient temperature of +23 °C +73.4 °F.
 2) The sensing range and the sensing object for the retroreflective type sensor are specified for the **RF-230** reflector. Further, the sensing range of **RX-PRVM3** and **RX-RVM5** is the possible setting range for the reflector. The sensor can detect an object less than 0.1 m 0.328 ft away.

3) The sensing range and the hysteresis of the diffuse reflective type sensor are specified for white non-glossy paper (200 × 200 mm 7.874 × 7.874 in) as the object.
 4) If slit masks (optional) are fitted on **RX-M10**, an object of 0.5 × 5 mm 0.020 × 0.197 in can be detected.
 5) Make sure to confirm detection with an actual sensor before use.

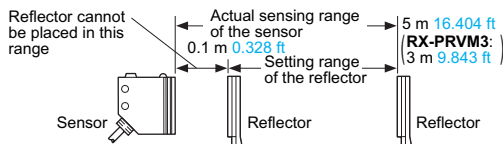

- FIBER SENSORS
- LASER SENSORS
- PHOTO-ELECTRIC SENSORS
- MICRO PHOTO-ELECTRIC SENSORS
- AREA SENSORS
- LIGHT CURTAINS / SAFETY COMPONENTS
- PRESSURE / FLOW SENSORS
- INDUCTIVE PROXIMITY SENSORS
- PARTICULAR USE SENSORS
- SENSOR OPTIONS
- SIMPLE WIRE-SAVING UNITS
- WIRE-SAVING SYSTEMS
- MEASURE-MENT SENSORS
- STATIC ELECTRICITY PREVENTION DEVICES
- LASER MARKERS
- PLC
- HUMAN MACHINE INTERFACES
- ENERGY CONSUMPTION VISUALIZATION COMPONENTS
- FA COMPONENTS
- MACHINE VISION SYSTEMS
- UV CURING SYSTEMS
- Selection Guide
- Amplifier Built-in
- Power Supply Built-in
- Amplifier-separated
- CX-400
- CY-100
- EX-10
- EX-20
- EX-30
- EX-40
- CX-440
- EQ-30
- EQ-500
- MQ-W
- RX-LS200
- RX**
- RT-610

SPECIFICATIONS

DC 2-wire type

Item	Type	Thru-beam	Retroreflective (with polarizing filters)	Diffuse reflective
	Model No.	RX2-M5	RX2-PRVM2	RX2-D300
Sensing range		5 m 16.404 ft	0.1 to 2 m 0.328 to 6.562 ft (Note 2)	300 mm 11.811 in (Note 3)
Sensing object		ø10 mm ø0.394 in or more opaque object (Note 4)	ø50 mm ø1.969 in or more opaque, translucent or specular object (Note 2, 5)	Opaque, translucent or transparent object (Note 5)
Hysteresis		————	————	15 % or less of operation distance (Note 3)
Repeatability (perpendicular to sensing axis)		0.5 mm 0.020 in or less	1 mm 0.039 in or less	0.5 mm 0.020 in or less
Supply voltage		12 to 24 V DC ±10 % Ripple P-P 10 % or less		
Current consumption		Emitter: 8 mA or less, Receiver: 0.8 mA or less (Note 6)	1 mA or less (Note 6)	
Sensing output		Non contact DC 2-wire type • Load current: 5 to 100 mA • Residual voltage: 4 V or less (Note 7)		
	Output operation	Switchable either Light-ON or Dark-ON		
	Short-circuit protection	Incorporated		
Response time		3 ms or less		
Operation indicator		Red LED (lights up when the output is ON)		
Stability indicator		Green LED (Light-ON mode: lights up under stable light received condition) Dark-ON mode: lights up under stable dark condition)		
Emitting indicator		Red LED (lights up during beam emission)	————	
Sensitivity adjuster		Continuously variable adjuster		
Environmental resistance	Protection	IP67 (IEC)		
	Ambient temperature	-20 to +60 °C -4 to +140 °F (No dew condensation or icing allowed), Storage: -30 to +70 °C -22 to +158 °F		
	Ambient humidity	35 to 85 % RH, Storage: 35 to 85 % RH		
	Ambient illuminance	Incandescent light: 3,500 lx at the light-receiving face		
	Voltage withstandability	1,000 V AC for one min. between all supply terminals connected together and enclosure		
	Insulation resistance	20 MΩ, or more, with 250 V DC megger between all supply terminals connected together and enclosure		
	Vibration resistance	10 to 500 Hz frequency, 1.5 mm 0.059 in amplitude (10 G max.) in X, Y and Z directions for two hours each		
Shock resistance	500 m/s ² acceleration (50 G approx.) in X, Y and Z directions for three times each			
Emitting element		Infrared LED (modulated)	Red LED (modulated)	Infrared LED (modulated)
	Peak emission wavelength	880 nm 0.035 mil	680 nm 0.027 mil	890 nm 0.035 mil
Material		Enclosure: Die-cast zinc alloy, Indicator cover: Polyethersulphone, Lens: Polycarbonate (RX2-PRVM2 : Acrylic)		
Cable		0.15 mm ² 2-core oil, heat and cold resistant cabtyre cable, 2 m 6.562 ft long		
Cable extension		———— (Note 7)		
Net weight		Emitter: 70 g approx., Receiver: 70 g approx.	75 g approx.	70 g approx.
Accessories		MS-RX-1 (Sensor mounting bracket): 1 set for emitter and receiver Adjusting screwdriver: 1 pc.	MS-RX-1 (Sensor mounting bracket): 1 set RF-230 (Reflector): 1 pc. Adjusting screwdriver: 1 pc.	MS-RX-1 (Sensor mounting bracket): 1 set Adjusting screwdriver: 1 pc.

Notes: 1) Where measurement conditions have not been specified precisely, the conditions used were an ambient temperature of +23 °C **+73.4 °F**.

2) The sensing range and the sensing object for **RX2-PRVM2** are specified for the **RF-230** reflector. Further, the sensing range is the possible setting range for the reflector. The sensor can detect an object less than 0.1 m **0.328 ft** away.

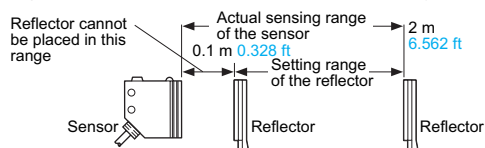

3) The sensing range and the hysteresis of **RX2-D300** are specified for white non-glossy paper (200 × 200 mm **7.874 × 7.874 in**) as the object.

4) If slit masks (optional) are fitted, an object of 0.5 × 5 mm **0.020 × 0.197 in** can be detected.

5) Make sure to confirm detection with an actual sensor before use.

6) It is the leakage current when the output is in the OFF state.

7) When extending the cable, the residual voltage will be increased depending on the type of cable used. Verify the residual voltage when extending the cable.

FIBER SENSORS

LASER SENSORS

PHOTO-ELECTRIC SENSORS

MICRO PHOTO-ELECTRIC SENSORS

AREA SENSORS

LIGHT CURTAINS / SAFETY COMPONENTS

PRESSURE / FLOW SENSORS

INDUCTIVE PROXIMITY SENSORS

PARTICULAR USE SENSORS

SENSOR OPTIONS

SIMPLE WIRE-SAVING UNITS

WIRE-SAVING SYSTEMS

MEASUREMENT SENSORS

STATIC ELECTRICITY PREVENTION DEVICES

LASER MARKERS

PLC

HUMAN MACHINE INTERFACES

ENERGY CONSUMPTION VISUALIZATION COMPONENTS

FA COMPONENTS

MACHINE VISION SYSTEMS

UV CURING SYSTEMS

Selection Guide

Amplifier Built-in

Power Supply Built-in

Amplifier-separated

CX-400

CY-100

EX-10

EX-20

EX-30

EX-40

CX-440

EQ-30

EQ-500

MQ-W

RX-LS200

RX

RT-610

SPECIFICATIONS

Heavy duty type

Item	Type Model No.	Thru-beam		
		Cable length 2 m 6.562 ft	Cable length 3 m 9.843 ft	Cable length 5 m 16.404 ft
		RX4-M5	RX4-M5-C3	RX4-M5-C5
Sensing range		5 m 16.404 ft		
Sensing object		ø10 mm ø0.394 in or more opaque object		
Repeatability (perpendicular to sensing axis)		0.5 mm 0.020 in or less		
Supply voltage		12 to 24 V DC ±10 % Ripple P-P 10 % or less		
Current consumption		Emitter: 20 mA or less, Receiver: 25 mA or less		
Sensing output		NPN open-collector transistor <ul style="list-style-type: none"> • Maximum sink current: 100 mA • Applied voltage: 30 V DC or less (between sensing output and 0 V) • Residual voltage: 2 V or less (at 100 mA sink current) 1 V or less (at 16 mA sink current) 		
Output operation		Switchable either Light-ON or Dark-ON		
Short-circuit protection		Incorporated		
Self-diagnosis output		NPN open-collector transistor <ul style="list-style-type: none"> • Maximum sink current: 50 mA • Applied voltage: 30 V DC or less (between self-diagnosis output and 0 V) • Residual voltage: 1.5 V or less (at 50 mA sink current) 1 V or less (at 16 mA sink current) 		
Output operation		ON under unstable sensing condition		
Short-circuit protection		—		
Response time		1 ms or less		
Test input (emission halt) function		Incorporated		
Operation indicator		Red LED (lights up when the sensing output is ON)		
Stability indicator		Green LED (lights up under stable light received condition or stable dark condition)		
Emitting indicator		Red LED (lights up during beam emission)		
Sensitivity adjuster		Continuously variable adjuster		
Environmental resistance	Protection	IP67 (IEC), IP67g (JEM)		
	Ambient temperature	-25 to +60 °C -13 to +140 °F (No dew condensation or icing allowed), Storage: -30 to +70 °C -22 to +158 °F		
	Ambient humidity	35 to 85 % RH, Storage: 35 to 85 % RH		
	Ambient illuminance	Incandescent light: 3,500 lx at the light-receiving face		
	Voltage withstandability	1,000 V AC for one min. between all supply terminals connected together and enclosure		
	Insulation resistance	20 MΩ, or more, with 250 V DC megger between all supply terminals connected together and enclosure		
	Vibration resistance	10 to 500 Hz frequency, 1.5 mm 0.059 in amplitude (10 G max.) in X, Y and Z directions for two hours each		
Shock resistance		500 m/s ² acceleration (50 G approx.) in X, Y and Z directions for three times each		
Emitting element		Infrared LED (Peak emission wavelength: 880 nm 0.035 mil , modulated)		
Material		Enclosure: Die-cast zinc alloy (Fluorine resin coating), Indicator cover: Polyethersulphone, Lens: Polyallylate, Protective tube sheath: Oil resistant PVC		
Cable		0.15 mm ² 4-core (emitter: 3-core) oil, heat and cold resistant cabtyre cable		
Protective tube length		1 m 3.281 ft	2 m 6.562 ft	4 m 13.123 ft
Cable extension		Extension up to total 100 m 328.084 ft is possible for both emitter and receiver with 0.3 mm ² , or more, cable.		
Net weight		Emitter: 175 g approx., Receiver: 175 g approx.	Emitter: 265 g approx., Receiver: 265 g approx.	Emitter: 495 g approx., Receiver: 495 g approx.
Accessories		MS-RX-2 (Sensor mounting bracket): 1 set for emitter and receiver, Adjusting screwdriver: 1 pc.		

Note: Where measurement conditions have not been specified precisely, the conditions used were an ambient temperature of +23 °C **+73.4 °F**.

FIBER
SENSORSLASER
SENSORSPHOTO-
ELECTRIC
SENSORSAREA
SENSORSLIGHT
CURTAINS/
SAFETY
COMPONENTSPRESSURE /
FLOW
SENSORSINDUCTIVE
PROXIMITY
SENSORSPARTICULAR
USE
SENSORSSENSOR
OPTIONSSIMPLE
WIRESAVING
UNITSWIRESAVING
SYSTEMSMEASURE-
MENT
SENSORSSTATIC
ELECTRICITY
PREVENTION
DEVICESLASER
MARKERS

PLC

HUMAN
MACHINE
INTERFACESENERGY
CONSUMPTION
VISUALIZATION
COMPONENTSFA
COMPONENTSMACHINE
VISION
SYSTEMSUV
CURING
SYSTEMSSelection
GuideAmplifier
Built-inPower Supply
Built-inAmplifier-
separated

CX-400

CY-100

EX-10

EX-20

EX-30

EX-40

CX-440

EQ-30

EQ-500

MQ-W

RX-LS200

RX

RT-610

I/O CIRCUIT AND WIRING DIAGRAMS

RX-□ RX4-□

I/O circuit diagrams

Emitter of thru-beam type sensor

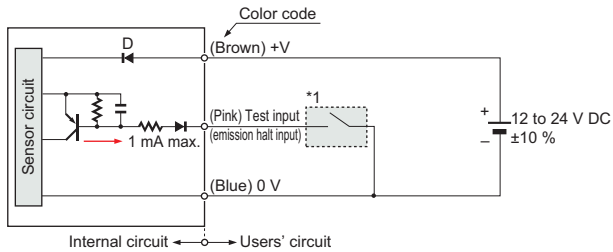

Symbols ... D: Reverse supply polarity protection diode

Wiring diagram

Emitter of thru-beam type sensor

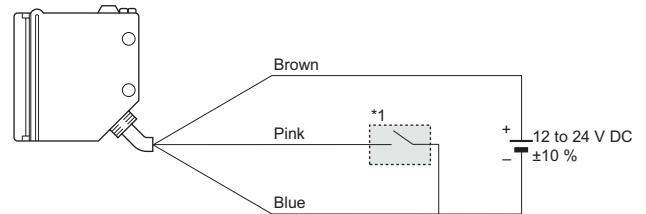

* 1

Non-voltage contact or NPN open-collector transistor

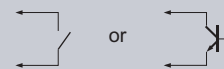

- Test input (emission halt input)
[Supply voltage – 2.5 V] or more: Emission
[Supply voltage – 3.3 V] or less: Emission halt

Receiver of thru-beam type sensor

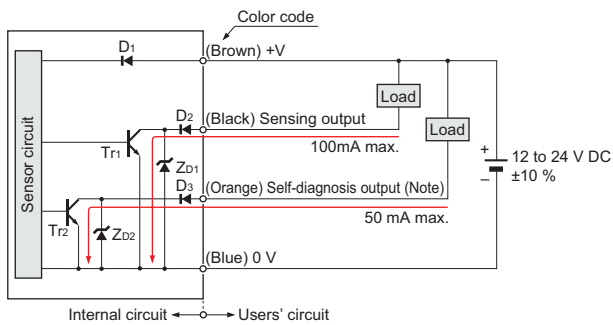

Note: The self-diagnosis output does not incorporate a short-circuit protection circuit. Do not connect it directly to a power supply or a capacitive load.

Symbols ... D1: Reverse supply polarity protection diode
D2, D3 : Reverse output polarity protection diode
ZD1, ZD2: Surge absorption zener diode
Tr1, Tr2 : NPN output transistor

Receiver of thru-beam type sensor

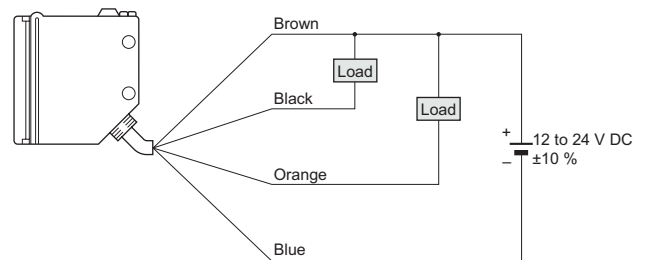

Retroreflective and diffuse reflective type sensors

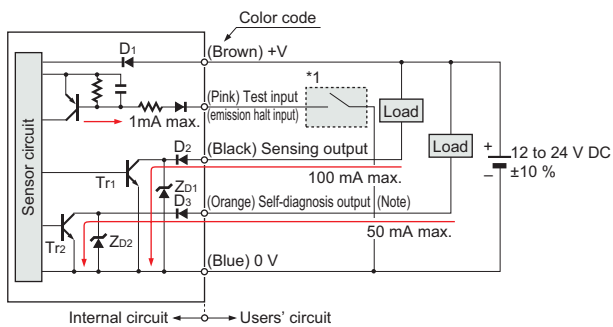

Note: The self-diagnosis output does not incorporate a short-circuit protection circuit. Do not connect it directly to a power supply or a capacitive load.

Symbols ... D1: Reverse supply polarity protection diode
D2, D3 : Reverse output polarity protection diode
ZD1, ZD2: Surge absorption zener diode
Tr1, Tr2 : NPN output transistor

Retroreflective and diffuse reflective type sensors

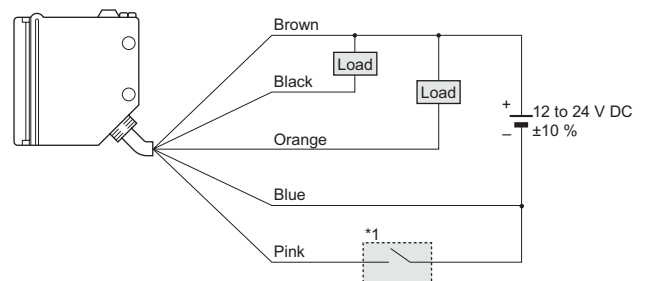

* 1

Non-voltage contact or NPN open-collector transistor

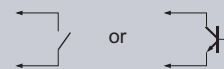

- Test input (emission halt input)
[Supply voltage – 2.5 V] or more: Emission
[Supply voltage – 3.3 V] or less: Emission halt

FIBER SENSORS

LASER SENSORS

PHOTO-ELECTRIC SENSORS

MICRO PHOTO-ELECTRIC SENSORS

AREA SENSORS

LIGHT CURTAINS / SAFETY COMPONENTS

PRESSURE / FLOW SENSORS

INDUCTIVE PROXIMITY SENSORS

PARTICULAR USE SENSORS

SENSOR OPTIONS

SIMPLE WIRE-SAVING UNITS

WIRE-SAVING SYSTEMS

MEASUREMENT SENSORS

STATIC ELECTRICITY PREVENTION DEVICES

LASER MARKERS

PLC

HUMAN MACHINE INTERFACES

ENERGY CONSUMPTION VISUALIZATION COMPONENTS

FA COMPONENTS

MACHINE VISION SYSTEMS

UV CURING SYSTEMS

Selection Guide

Amplifier Built-in

Power Supply Built-in

Amplifier-separated

CX-400

CY-100

EX-10

EX-20

EX-30

EX-40

CX-440

EQ-30

EQ-500

MQ-W

RX-LS200

RX

RT-610

- FIBER SENSORS
- LASER SENSORS
- PHOTO-ELECTRIC SENSORS
- MICRO PHOTO-ELECTRIC SENSORS
- AREA SENSORS
- LIGHT CURTAINS / SAFETY COMPONENTS
- PRESSURE / FLOW SENSORS
- INDUCTIVE PROXIMITY SENSORS
- PARTICULAR USE SENSORS
- SENSOR OPTIONS
- SIMPLE WIRE-SAVING UNITS
- WIRE-SAVING SYSTEMS
- MEASUREMENT SENSORS
- STATIC ELECTRICITY PREVENTION DEVICES
- LASER MARKERS
- PLC
- HUMAN MACHINE INTERFACES
- ENERGY CONSUMPTION VISUALIZATION COMPONENTS
- FA COMPONENTS
- MACHINE VISION SYSTEMS
- UV CURING SYSTEMS

I/O CIRCUIT AND WIRING DIAGRAMS

RX2-□

I/O circuit diagrams

Emitter of thru-beam type sensor

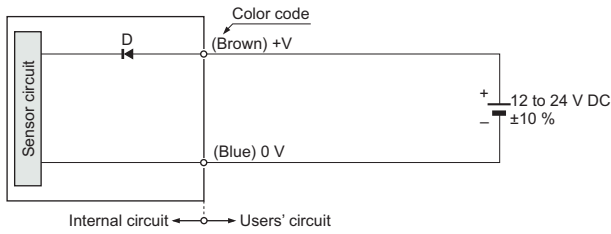

Symbol ... D: Reverse supply polarity protection diode

Receiver of thru-beam type sensor, retroreflective and diffuse reflective type sensors

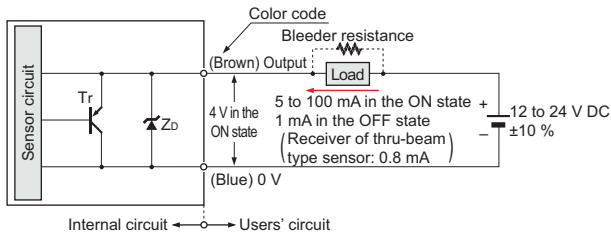

Symbols ... D : Reverse supply polarity protection diode
Zd: Surge absorption zener diode
Tr : PNP output transistor

Conditions for the load

- 1) The load should not be actuated by the leakage current (1 mA; 0.8 mA for receiver of thru-beam type sensor) in the OFF state.
- 2) The load should be actuated by (supply voltage – 4 V) in the ON state.
- 3) The current in the ON state should be between 5 to 100 mA DC.

[In case the current is less than 5 mA, connect a bleeder resistance in parallel to the load (shown in dotted line above) so that a current of 5 mA, or more, flows.]

Wiring diagrams

Emitter of thru-beam type sensor

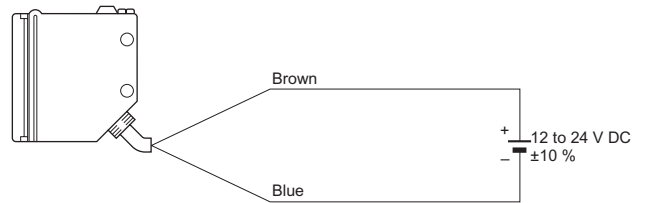

Receiver of thru-beam type sensor, retroreflective and diffuse reflective type sensors

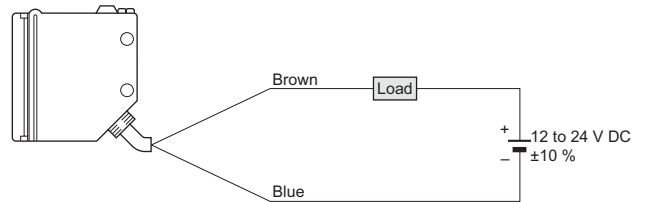

SENSING CHARACTERISTICS (TYPICAL)

RX-□

All models

Correlation between setting distance and excess gain

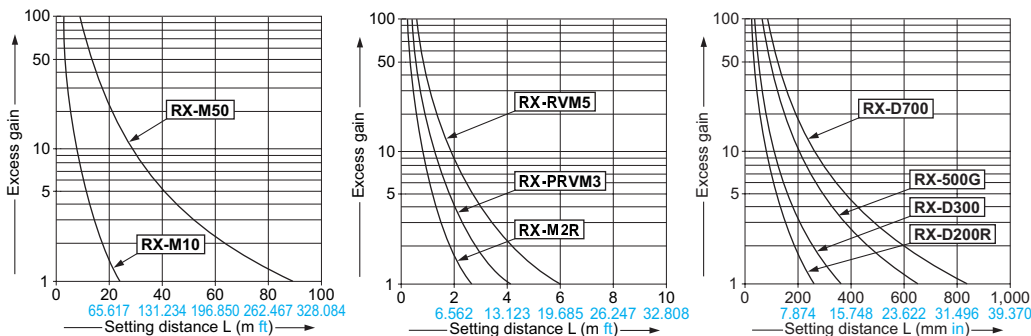

- Selection Guide
- Amplifier Built-in
- Power Supply Built-in
- Amplifier-separated
- CX-400
- CY-100
- EX-10
- EX-20
- EX-30
- EX-40
- CX-440
- EQ-30
- EQ-500
- MQ-W
- RX-LS200
- RX
- RT-610

SENSING CHARACTERISTICS (TYPICAL)

RX-M10

Thru-beam type

Parallel deviation

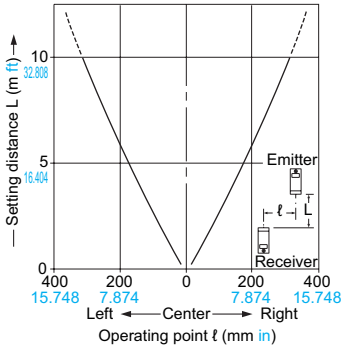

Parallel deviation with slit masks
(0.5 × 5 mm 0.020 × 0.197 in)

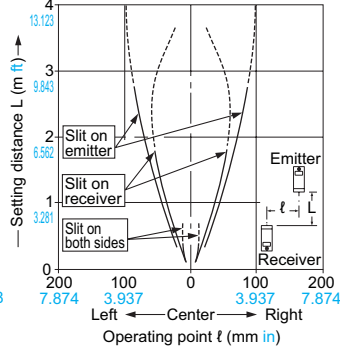

Parallel deviation with slit masks
(1 × 5 mm 0.039 × 0.197 in)

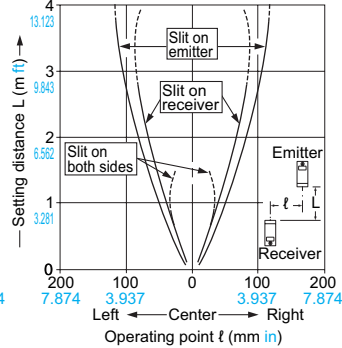

Parallel deviation with slit masks
(3 × 5 mm 0.118 × 0.197 in)

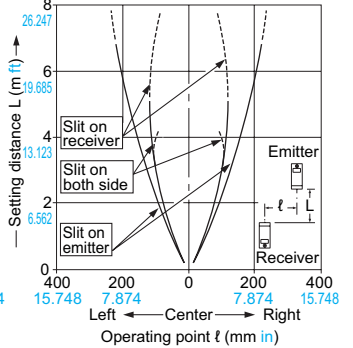

RX-M50

Thru-beam type

Parallel deviation

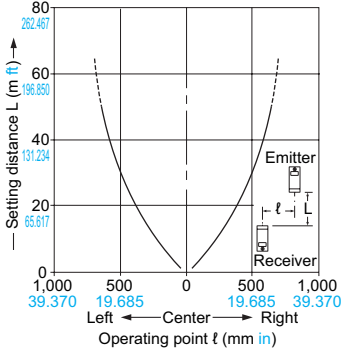

RX-M2R

Thru-beam type

Parallel deviation

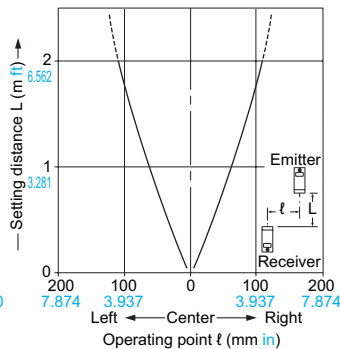

RX-500G

Thru-beam type

Parallel deviation

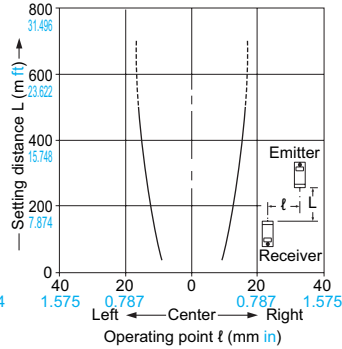

RX4-M5□

Thru-beam type

Parallel deviation

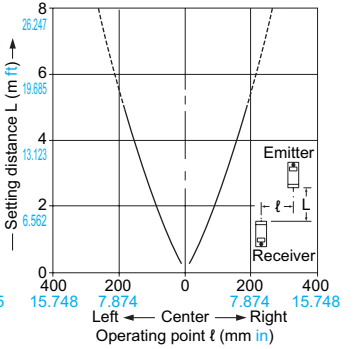

RX2-M5

Thru-beam type

Parallel deviation

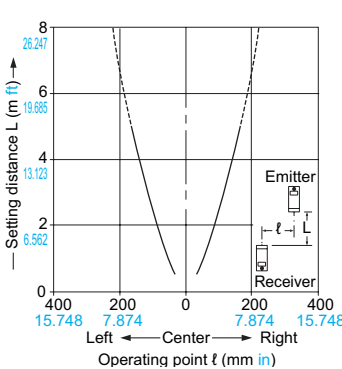

Parallel deviation with slit masks
(0.5 × 5 mm 0.020 × 0.197 in)

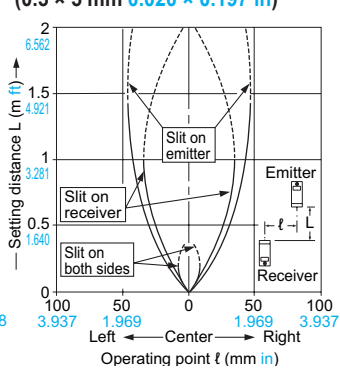

Parallel deviation with slit masks
(1 × 5 mm 0.039 × 0.197 in)

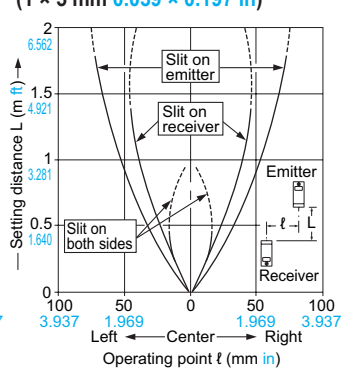

Parallel deviation with slit masks
(3 × 5 mm 0.118 × 0.197 in)

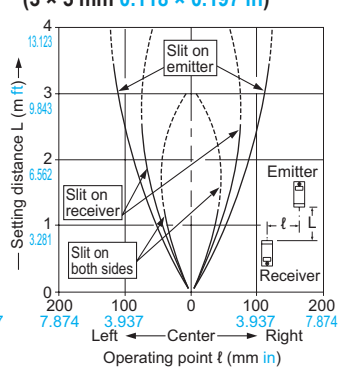

RX-PRVM3

Retroreflective type

Parallel deviation

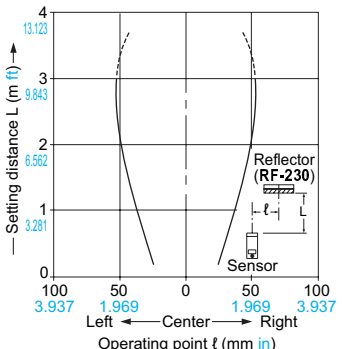

RX-RVM5

Retroreflective type

Parallel deviation

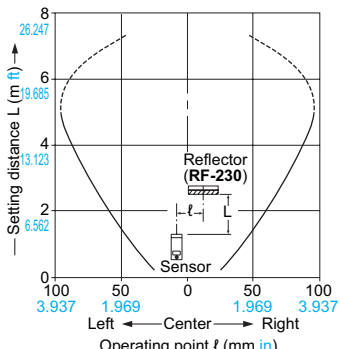

RX2-PRVM2

Retroreflective type

Parallel deviation

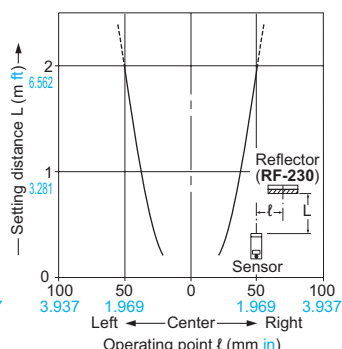

FIBER SENSORS

LASER SENSORS

PHOTO-ELECTRIC SENSORS

MICRO PHOTO-ELECTRIC SENSORS

AREA SENSORS

LIGHT CURTAINS / SAFETY COMPONENTS

PRESSURE / FLOW SENSORS

INDUCTIVE PROXIMITY SENSORS

PARTICULAR USE SENSORS

SENSOR OPTIONS

WIRE-SAVING UNITS

WIRE-SAVING SYSTEMS

MEASUREMENT SENSORS

STATIC ELECTRICITY PREVENTION DEVICES

LASER MARKERS

PLC

HUMAN MACHINE INTERFACES

ENERGY CONSUMPTION VISUALIZATION COMPONENTS

FA COMPONENTS

MACHINE VISION SYSTEMS

UV CURING SYSTEMS

Selection Guide

Amplifier Built-in

Power Supply Built-in

Amplifier-separated

CX-400

CY-100

EX-10

EX-20

EX-30

EX-40

CX-440

EQ-30

EQ-500

MQ-W

RX-LS200

RX

RT-610

SENSING CHARACTERISTICS (TYPICAL)

RX-D700

Diffuse reflective type

Sensing field

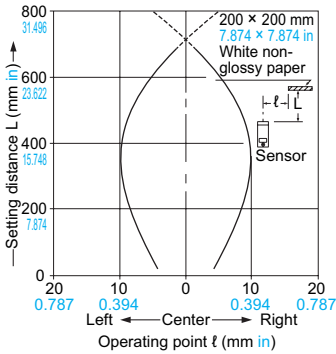

Correlation between sensing object size and sensing range

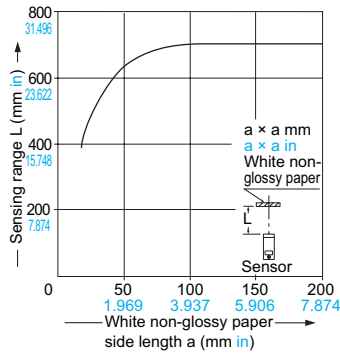

As the sensing object size becomes smaller than the standard size (white non-glossy paper 200 × 200 mm 7.874 × 7.874 in), the sensing range shortens, as shown in the left graph.

(For plotting the left graph, the sensitivity has been set such that a 200 × 200 mm 7.874 × 7.874 in white non-glossy paper is just detectable at a distance of 700 mm 27.559 in.)

RX-D200R

Diffuse reflective type

Sensing field

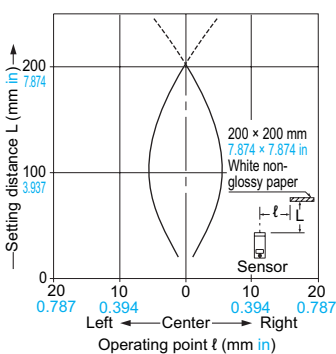

Correlation between sensing object size and sensing range

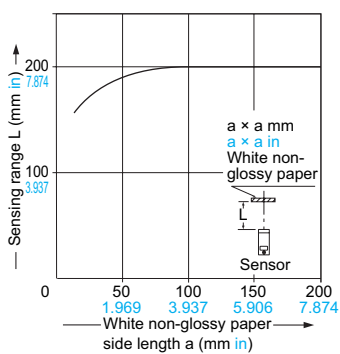

As the sensing object size becomes smaller than the standard size (white non-glossy paper 200 × 200 mm 7.874 × 7.874 in), the sensing range shortens, as shown in the left graph.

(For plotting the left graph, the sensitivity has been set such that a 200 × 200 mm 7.874 × 7.874 in white non-glossy paper is just detectable at a distance of 200 mm 7.874 in.)

RX2-D300

Diffuse reflective type

Sensing field

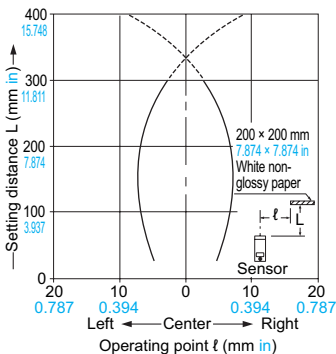

Correlation between sensing object size and sensing range

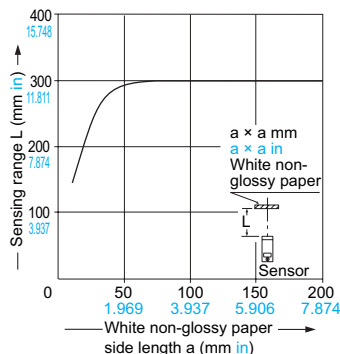

As the sensing object size becomes smaller than the standard size (white non-glossy paper 200 × 200 mm 7.874 × 7.874 in), the sensing range shortens, as shown in the left graph.

(For plotting the left graph, the sensitivity has been set such that a 200 × 200 mm 7.874 × 7.874 in white non-glossy paper is just detectable at a distance of 300 mm 11.811 in.)

PRECAUTIONS FOR PROPER USE

Refer to p.1458~ for general precautions.



- Never use this product as a sensing device for personnel protection.
- In case of using sensing devices for personnel protection, use products which meet laws and standards, such as OSHA, ANSI or IEC etc., for personnel protection applicable in each region or country.

Mounting

- The tightening torque should be 1.17 N·m or less.

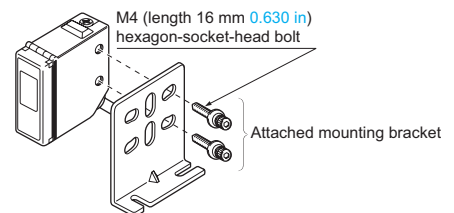

Others

- Do not use during the initial transient time (50 ms) after the power supply is switched on.

Wiring

- The self-diagnosis output does not incorporate a short-circuit protection circuit. Do not connect it directly to a power supply or a capacitive load.

FIBER SENSORS

LASER SENSORS

PHOTO-ELECTRIC SENSORS

MICRO PHOTO-ELECTRIC SENSORS

AREA SENSORS

LIGHT CURTAINS/SAFETY COMPONENTS

PRESSURE / FLOW SENSORS

INDUCTIVE PROXIMITY SENSORS

PARTICULAR USE SENSORS

SENSOR OPTIONS

SIMPLE WIRE-SAVING UNITS

WIRE-SAVING SYSTEMS

MEASUREMENT SENSORS

STATIC ELECTRICITY PREVENTION DEVICES

LASER MARKERS

PLC

HUMAN MACHINE INTERFACES

ENERGY CONSUMPTION VISUALIZATION COMPONENTS

FA COMPONENTS

MACHINE VISION SYSTEMS

UV CURING SYSTEMS

Selection Guide

Amplifier Built-in

Power Supply Built-in

Amplifier-separated

CX-400

CY-100

EX-10

EX-20

EX-30

EX-40

CX-440

EQ-30

EQ-500

MQ-W

RX-LS200

RX

RT-610

PRECAUTIONS FOR PROPER USE

Refer to p.1458~ for general precautions.

RX-RVM5**Glossy object sensing**

- Please take care of the following points when detecting materials having a gloss.
- ① Make L, shown in the diagram, sufficiently long.
- ② Install at an angle of 10 to 30 degrees to the sensing object.

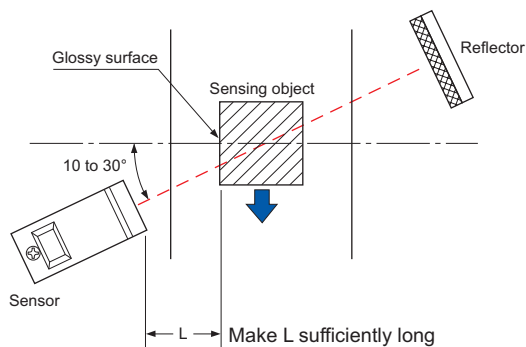
**RX-PRVM3 RX2-PRVM2****Retroreflective type sensor with polarizing filters**

- If a shiny object is covered or wrapped with a transparent film such as those described below, the retroreflective type sensor with polarizing filters may not be able to detect it.
- In that case, follow the steps given below.

Example of sensing objects

- Can wrapped by clear film
- Aluminum sheet covered by plastic film
- Gold or silver color (specular) label or wrapping paper

Steps

- Tilt the sensor with respect to the sensing object while fitting.
- Reduce the sensitivity.
- Increase the distance between the sensor and the sensing object.

RX2-□**Wiring**

- Always connect the sensor to the power supply through a load. If the sensor is connected to the power supply directly, the short-circuit protection makes the sensor inoperable. (The output stays in the OFF state and no indicator lights up.) If this happens, connect the sensor to the power supply through a load. Further, note that the sensor will be damaged if the power supply is connected in reverse without a load.

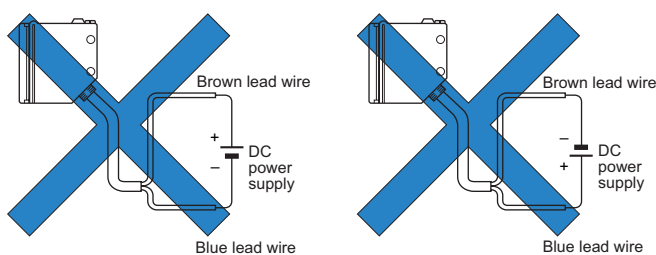

- Do not connect sensors in series (AND circuit).

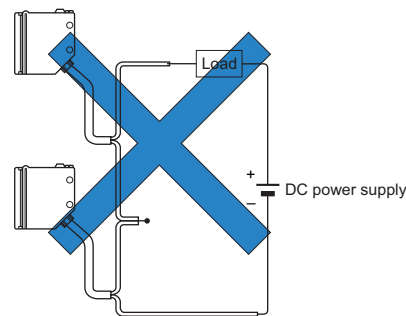

- The residual voltage of the sensor is 4 V. Before connecting to a relay, be aware of the actuation voltage of the relay. (Not all 12 V relays may be connected as the load.)

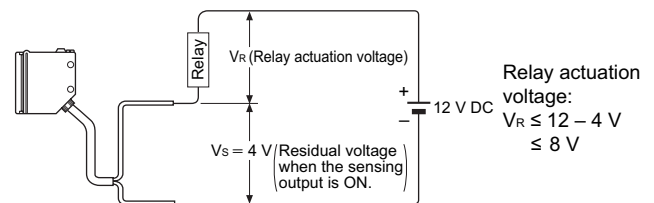
**RX4-□****Connection of protective tube connector**

- Connect the junction connector securely as shown below. The tightening torque should be 0.98 N·m or less.

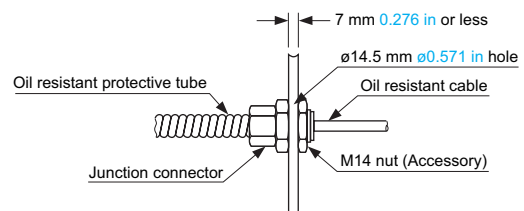
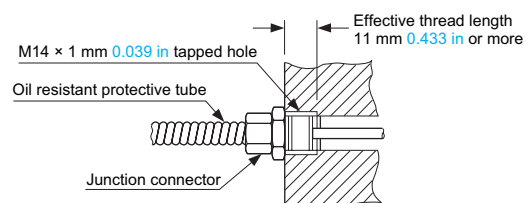
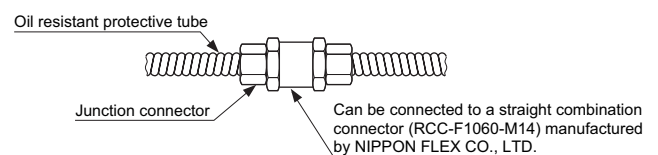
When mounted on a plate**When mounted with a female screw****When connected to another protective tube**

FIBER SENSORS

LASER SENSORS

PHOTO-ELECTRIC SENSORS

MICRO PHOTO-ELECTRIC SENSORS

AREA SENSORS

LIGHT CURTAINS / SAFETY COMPONENTS

PRESSURE / FLOW SENSORS

INDUCTIVE PROXIMITY SENSORS

PARTICULAR USE SENSORS

SENSOR OPTIONS

SIMPLE WIRE-SAVING UNITS

WIRE-SAVING SYSTEMS

MEASUREMENT SENSORS

STATIC ELECTRICITY PREVENTION DEVICES

LASER MARKERS

PLC

HUMAN MACHINE INTERFACES

ENERGY CONSUMPTION VISUALIZATION COMPONENTS

FA COMPONENTS

MACHINE VISION SYSTEMS

UV CURING SYSTEMS

Selection Guide

Amplifier Built-in

Power Supply Built-in

Amplifier-separated

CX-400

CY-100

EX-10

EX-20

EX-30

EX-40

CX-440

EQ-30

EQ-500

MQ-W

RX-LS200

RX

RT-610

The CAD data in the dimensions can be downloaded from our website. Refer to **CX-400** series pages (p.301~) for dimensions of the reflector or the reflector mounting bracket.

- FIBER SENSORS
- LASER SENSORS
- PHOTO-ELECTRIC SENSORS
- MICRO PHOTO-ELECTRIC SENSORS
- AREA SENSORS
- LIGHT CURTAINS/ SAFETY COMPONENTS
- PRESSURE / FLOW SENSORS
- INDUCTIVE PROXIMITY SENSORS
- PARTICULAR USE SENSORS
- SENSOR OPTIONS
- SIMPLE WIRE-SAVING UNITS
- WIRE-SAVING SYSTEMS
- MEASURE-MENT SENSORS
- STATIC ELECTRICITY PREVENTION DEVICES
- LASER MARKERS
- PLC
- HUMAN MACHINE INTERFACES
- ENERGY CONSUMPTION VISUALIZATION COMPONENTS
- FA COMPONENTS
- MACHINE VISION SYSTEMS
- UV CURING SYSTEMS
- Selection Guide
- Amplifier Built-in
- Power Supply Built-in
- Amplifier-separated
- CX-400
- CY-100
- EX-10
- EX-20
- EX-30
- EX-40
- CX-440
- EQ-30
- EQ-500
- MQ-W
- RX-LS200
- RX**
- RT-610

DIMENSIONS (Unit: mm in) **RX-M10 RX-M2R RX-500G RX2-M5** Sensor

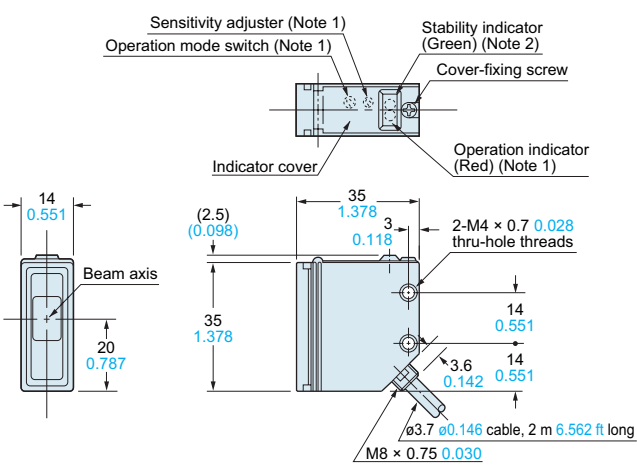

Notes: 1) Not incorporated on the emitter.
2) It is the emitting indicator (red) on the emitter.

RX-M50 Sensor

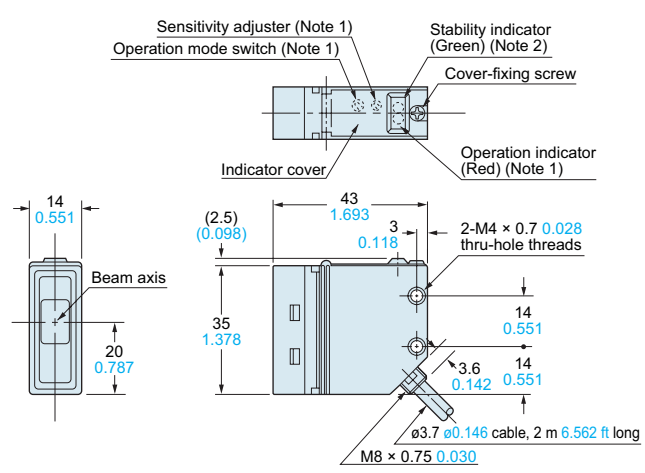

Notes: 1) Not incorporated on the emitter.
2) It is the emitting indicator (red) on the emitter.

RX4-M5□ Sensor

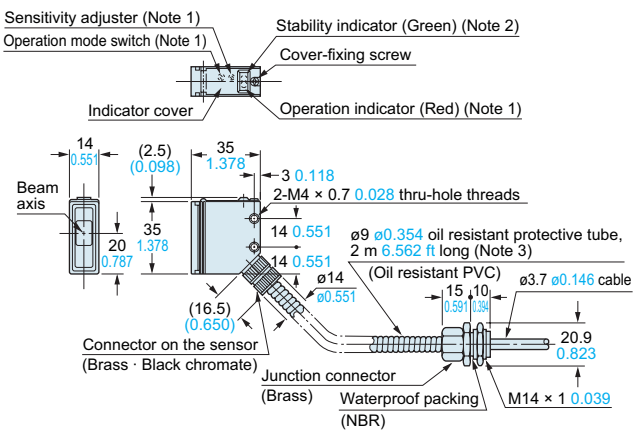

Notes: 1) Not incorporated on the emitter.
2) It is the emitting indicator (red) on the emitter.
3) The given length of the protective tube is for **RX4-M5-C3**.
(**RX4-M5**: 1 m 3.281 ft, **RX4-M5-C5**: 4 m 13.123 ft)

RX-PRVM3 RX-RVM5 RX2-PRVM2 Sensor

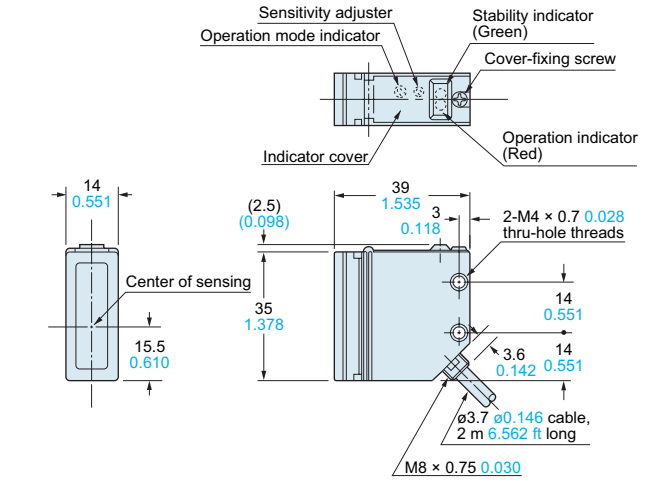

RX-D700 RX-D200R RX2-D300 Sensor

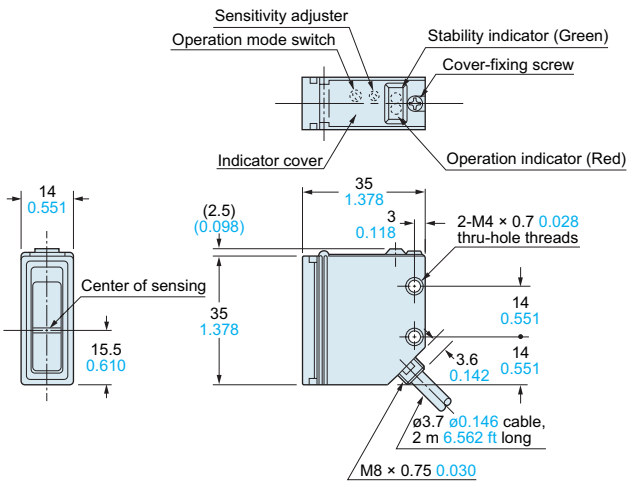

DIMENSIONS (Unit: mm in) The CAD data in the dimensions can be downloaded from our website. Refer to **CX-400** series pages (p.301~) for dimensions of the reflector or the reflector mounting bracket.

MS-RX-1 Sensor mounting bracket (Accessory for **RX-□, RX2-□**)

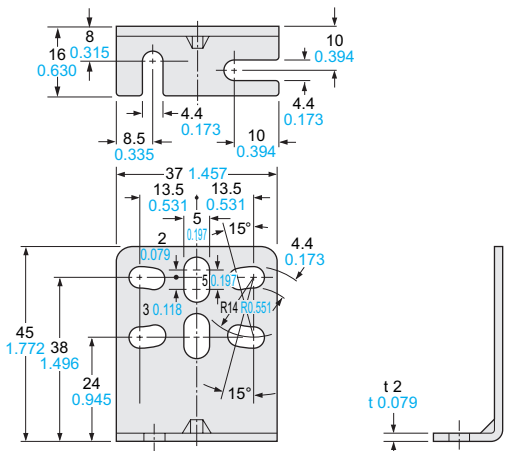

Material: Cold rolled carbon steel (SPCC)
Two M4 (length 16 mm 0.630 in) hexagon-socket-head bolts are attached.

Assembly dimensions

Mounting drawing with **RX-D700**

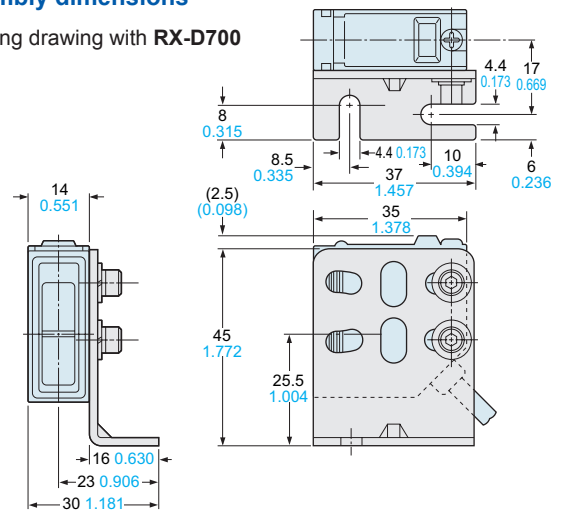

MS-RX-2 Sensor mounting bracket (Accessory for **RX4-□**)

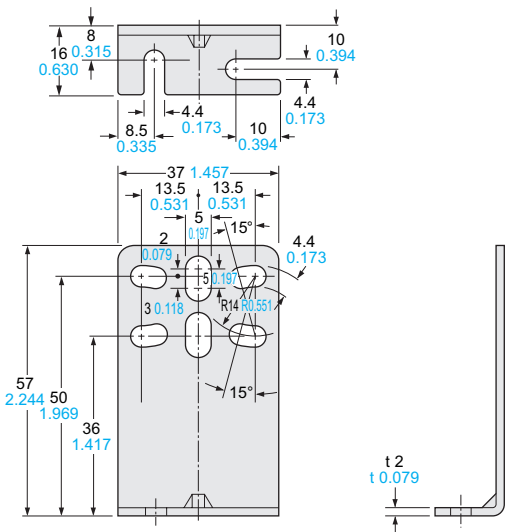

Material: Cold rolled carbon steel (SPCC)
Two M4 (length 16 mm 0.630 in) hexagon-socket-head bolts are attached.

Assembly dimensions

Mounting drawing with **RX4-M5**

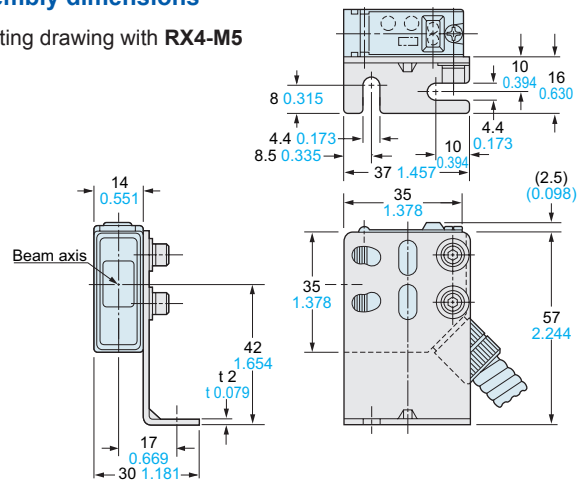

PT-RX500 PT-RX1000 Protective tube (Optional)

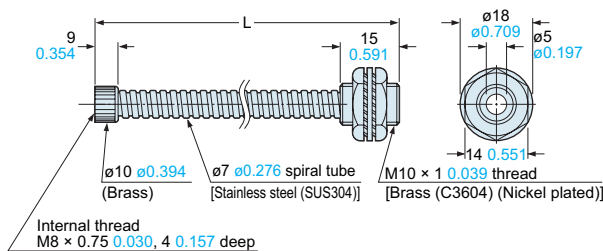

• Length L

Model No.	Length L
PT-RX500	500 + 10 ₀ 19.685 + 0.394
PT-RX1000	1,000 + 10 ₀ 39.370 + 0.394

- FIBER SENSORS
- LASER SENSORS
- PHOTO-ELECTRIC SENSORS
- MICRO PHOTO-ELECTRIC SENSORS
- AREA SENSORS
- LIGHT CURTAINS / SAFETY COMPONENTS
- PRESSURE / FLOW SENSORS
- INDUCTIVE PROXIMITY SENSORS
- PARTICULAR USE SENSORS
- SENSOR OPTIONS
- SMILE WIRE-SAVING UNITS
- WIRE-SAVING SYSTEMS
- MEASURE-MENT SENSORS
- STATIC ELECTRICITY PREVENTION DEVICES
- LASER MARKERS
- PLC
- HUMAN MACHINE INTERFACES
- ENERGY CONSUMPTION VISUALIZATION COMPONENTS
- FA COMPONENTS
- MACHINE VISION SYSTEMS
- UV CURING SYSTEMS
- Selection Guide
- Amplifier Built-in
- Power Supply Built-in
- Amplifier-separated
- CX-400
- CY-100
- EX-10
- EX-20
- EX-30
- EX-40
- CX-440
- EQ-30
- EQ-500
- MQ-W
- RX-LS200
- RX
- RT-610