



Chipsmall Limited consists of a professional team with an average of over 10 year of expertise in the distribution of electronic components. Based in Hongkong, we have already established firm and mutual-benefit business relationships with customers from,Europe,America and south Asia,supplying obsolete and hard-to-find components to meet their specific needs.

With the principle of “Quality Parts,Customers Priority,Honest Operation,and Considerate Service”,our business mainly focus on the distribution of electronic components. Line cards we deal with include Microchip,ALPS,ROHM,Xilinx,Pulse,ON,Everlight and Freescale. Main products comprise IC,Modules,Potentiometer,IC Socket,Relay,Connector.Our parts cover such applications as commercial,industrial, and automotives areas.

We are looking forward to setting up business relationship with you and hope to provide you with the best service and solution. Let us make a better world for our industry!



Contact us

Tel: +86-755-8981 8866 Fax: +86-755-8427 6832

Email & Skype: info@chipsmall.com Web: www.chipsmall.com

Address: A1208, Overseas Decoration Building, #122 Zhenhua RD., Futian, Shenzhen, China



PTC Thermistors, Mini Chips for Over-Temperature Protection



FEATURES

- Well-defined protection temperature levels
- Fast reaction time (< 6 s in still air)
- Accurate resistance for ease of circuit design
- Excellent long term behavior (< 1 °C or 5 % after 1000 h at $T_n + 15$ °C)
- Wide range of protection temperatures (70 °C to 170 °C)
- No need to reset supply after overtemperature switch
- Small size and rugged
- Coated leaded and naked devices available
- Compliant to RoHS directive 2002/95/EC and in accordance to WEEE 2002/96/EC



RoHS
COMPLIANT

QUICK REFERENCE DATA

PARAMETER	VALUE	UNIT
Maximum resistance at 25 °C	100	Ω
Minimum resistance at ($T_n + 15$) °C	4000	Ω
Maximum (DC) voltage	30	V
Temperature range	- 20 to ($T_n + 15$)	°C
Weight	≈ 0.006	g
Climatic category	25/125/56	

APPLICATIONS

Over-temperature protection and control in:

- Industrial electronics
- Power supplies
- Electronic data processing
- Motor protection

DESCRIPTION

These directly heated thermistors have a positive temperature coefficient and are primarily intended for sensing.

NOMINAL WORKING TEMPERATURES AND ORDERING INFORMATION

NOMINAL WORKING TEMPERATURE				CATALOG NUMBER 2381 671
T_n (°C)	RESISTANCE from - 20 °C to $T_n - 20$ °C (Ω)	RESISTANCE at $T_n - 5$ °C (Ω)	RESISTANCE at $T_n + 5$ °C (kΩ)	NAKED CHIP ⁽¹⁾
				1.7 x 1.7 (mm)
70	30 to 250	50 to 570	0.57 to 50	91002
80	30 to 250	50 to 550	1.33 to 50	91003
90	30 to 250	50 to 550	1.33 to 50	91004
100	30 to 250	50 to 550	1.33 to 50	91005
110	30 to 250	50 to 550	1.33 to 50	91006
120	30 to 250	50 to 550	1.33 to 50	91007
130	30 to 250	50 to 550	1.33 to 50	91009
140	30 to 250	50 to 550	1.33 to 50	91012
150	30 to 250	50 to 550	1.33 to 50	91014
155	30 to 250	50 to 550	1.33 to 50	91015
160	30 to 250	50 to 550	1.33 to 50	91016
170	30 to 250	50 to 550	1.33 to 50	91017

Note

⁽¹⁾ Naked chips are packed in a hermetically-sealed alu-plastic bag



ELECTRICAL CHARACTERISTICS	
PARAMETER	VALUES
Maximum resistance at 25 °C	100 Ω
Maximum resistance at $(T_n - 5)$ °C	See Nominal Working Temperatures and Ordering Information table
Minimum resistance at $(T_n + 15)$ °C	4000 Ω
Minimum resistance at $(T_n + 5)$ °C	See Nominal Working Temperatures and Ordering Information table
Maximum voltage	30 V (AC or DC)

CATALOG NUMBERS AND PACKAGING		
12NC	SAP	SPQ
2381 671 91002	PTCSC17T071DBE	5000
2381 671 91003	PTCSC17T081DBE	5000
2381 671 91004	PTCSC17T091DBE	5000
2381 671 91005	PTCSC17T101DBE	5000
2381 671 91006	PTCSC17T111DBE	5000
2381 671 91007	PTCSC17T121DBE	5000
2381 671 91009	PTCSC17T131DBE	5000
2381 671 91012	PTCSC17T141DBE	5000
2381 671 91014	PTCSC17T151DBE	5000
2381 671 91015	PTCSC17T155DBE	5000
2381 671 91016	PTCSC17T161DBE	5000
2381 671 91017	PTCSC17T171DBE	5000

COMPONENT OUTLINES DIMENSIONS in millimeters

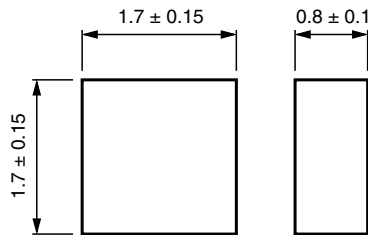

Component outline for 91002 to 91017

For clamping, reflow or hand soldering. Not intended for either wave or ultrasonic soldering and not for spot welding. All standard solder alloys with low activated halogene-free fluxes are acceptable, for example: 62Sn/36Pb/2Ag.

TYPICAL RESISTANCE/TEMPERATURE CHARACTERISTIC FOR 2381 671 91002, 2381 671 91003 and 2381 671 91004

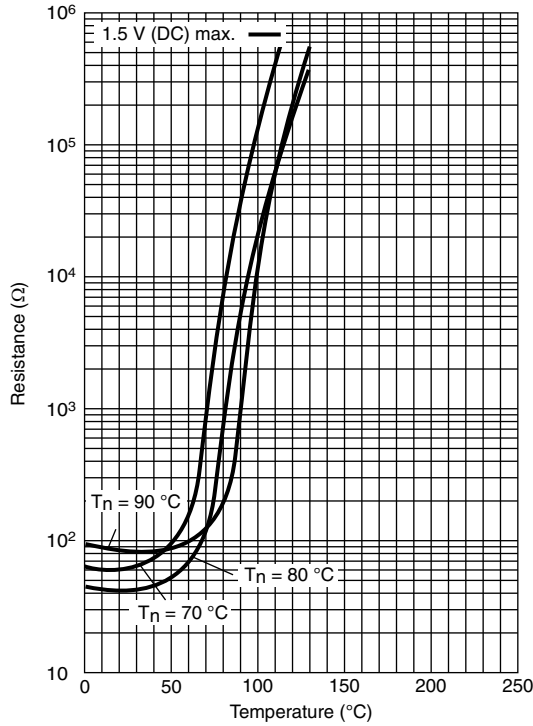

TYPICAL RESISTANCE/TEMPERATURE CHARACTERISTIC FOR 2381 671 91005, 2381 671 91006 and 2381 671 91007

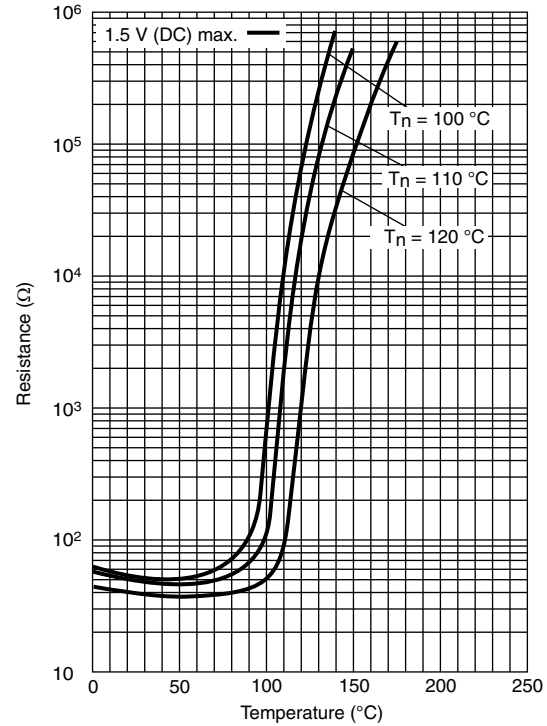

TYPICAL RESISTANCE/TEMPERATURE CHARACTERISTIC FOR 2381 671 91009, 2381 671 91012 and 2381 671 91014

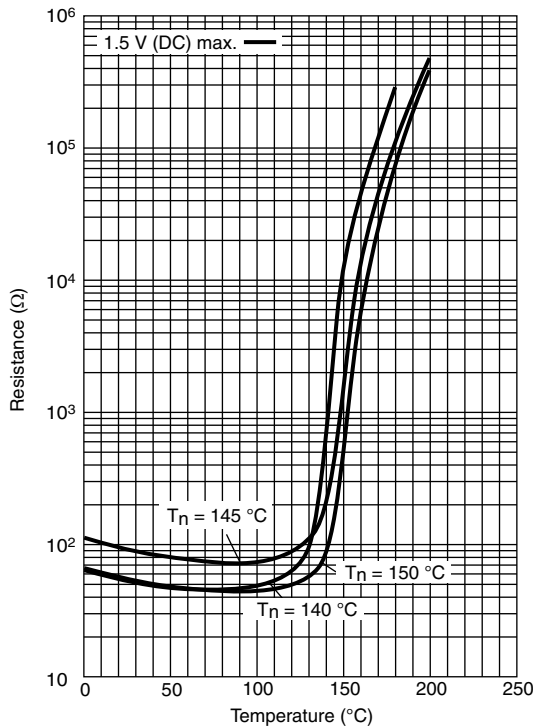

TYPICAL RESISTANCE/TEMPERATURE CHARACTERISTIC FOR 2381 671 91015, 2381 671 91016 and 2381 671 91017

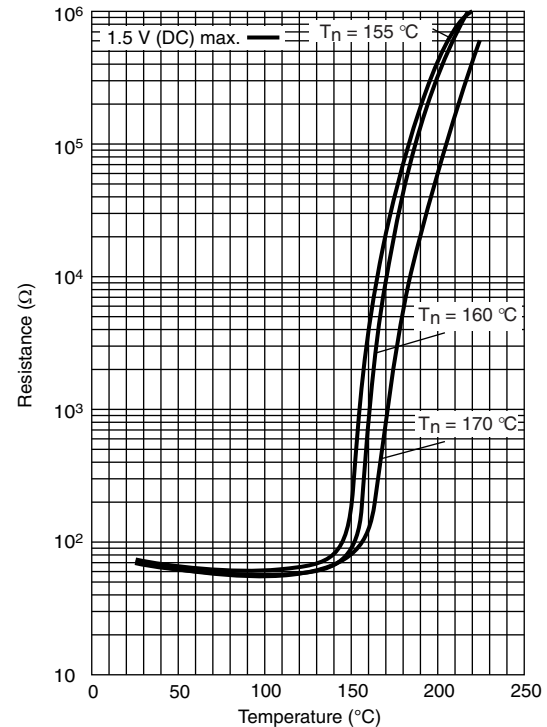

APPLICATION SPECIFIC DATA

Negative Temperature Coefficient (NTC) thermistors are well known for temperature sensing. What is not well known, however, is that Positive Temperature Coefficient (PTC) thermistors can be used for thermal protection. Although their operating principles are similar, the applications are very different; whereas NTC thermistors sense and measure temperature over a defined range, PTC thermistors switch at one particular temperature.

Just like thermostats they protect such equipment and components as motors, transformers, power transistors and thyristors against overtemperature. A PTC thermistor is less expensive than a thermostat, and its switch temperature can be more accurately specified. It is also smaller and easier to design-in to electronic circuitry.

The PTC thermistor is mounted in thermal contact with the equipment to be protected, and connected into the bridge arm of a comparator circuit, such as shown in Fig. 1. At normal temperature, the PTC thermistor resistance (R_p) is lower than R_s (see Fig. 2), so the comparator's output voltage V_o will be low. If an equipment overtemperature occurs, the PTC thermistor will quickly heat up to its trigger or nominal reference temperature T_n , whereupon its resistance will increase to a value much higher than R_s , causing V_o to switch to a high level sufficient to activate an alarm, relay or power shutdown circuit.

APPLICATION EXAMPLES

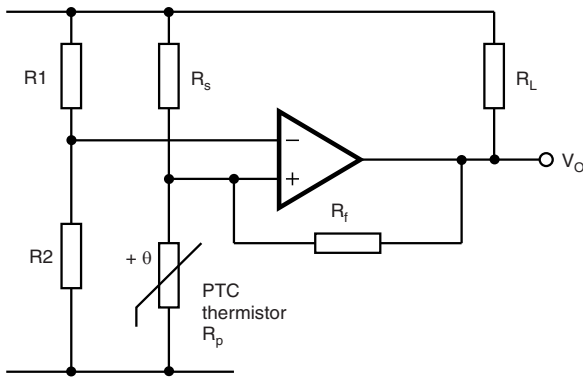

Fig. 1 Typical comparator circuit

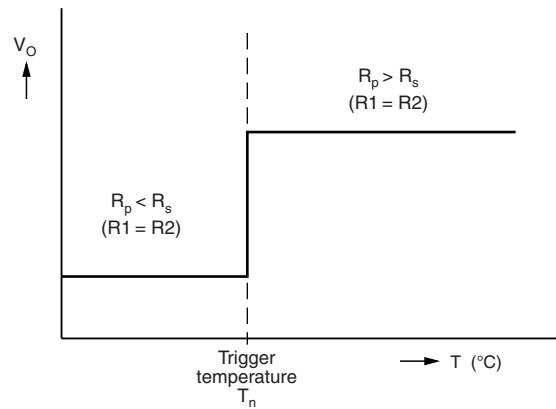
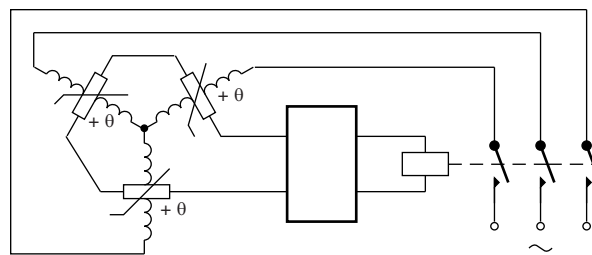

Fig. 2 Typical switch characteristic



As soon as one or more of the windings becomes too hot, the motor is switched off.

Fig. 3 Temperature protection of electric motors



Disclaimer

ALL PRODUCT, PRODUCT SPECIFICATIONS AND DATA ARE SUBJECT TO CHANGE WITHOUT NOTICE TO IMPROVE RELIABILITY, FUNCTION OR DESIGN OR OTHERWISE.

Vishay Intertechnology, Inc., its affiliates, agents, and employees, and all persons acting on its or their behalf (collectively, "Vishay"), disclaim any and all liability for any errors, inaccuracies or incompleteness contained in any datasheet or in any other disclosure relating to any product.

Vishay makes no warranty, representation or guarantee regarding the suitability of the products for any particular purpose or the continuing production of any product. To the maximum extent permitted by applicable law, Vishay disclaims (i) any and all liability arising out of the application or use of any product, (ii) any and all liability, including without limitation special, consequential or incidental damages, and (iii) any and all implied warranties, including warranties of fitness for particular purpose, non-infringement and merchantability.

Statements regarding the suitability of products for certain types of applications are based on Vishay's knowledge of typical requirements that are often placed on Vishay products in generic applications. Such statements are not binding statements about the suitability of products for a particular application. It is the customer's responsibility to validate that a particular product with the properties described in the product specification is suitable for use in a particular application. Parameters provided in datasheets and/or specifications may vary in different applications and performance may vary over time. All operating parameters, including typical parameters, must be validated for each customer application by the customer's technical experts. Product specifications do not expand or otherwise modify Vishay's terms and conditions of purchase, including but not limited to the warranty expressed therein.

Except as expressly indicated in writing, Vishay products are not designed for use in medical, life-saving, or life-sustaining applications or for any other application in which the failure of the Vishay product could result in personal injury or death. Customers using or selling Vishay products not expressly indicated for use in such applications do so at their own risk. Please contact authorized Vishay personnel to obtain written terms and conditions regarding products designed for such applications.

No license, express or implied, by estoppel or otherwise, to any intellectual property rights is granted by this document or by any conduct of Vishay. Product names and markings noted herein may be trademarks of their respective owners.

Material Category Policy

Vishay Intertechnology, Inc. hereby certifies that all its products that are identified as RoHS-Compliant fulfill the definitions and restrictions defined under Directive 2011/65/EU of The European Parliament and of the Council of June 8, 2011 on the restriction of the use of certain hazardous substances in electrical and electronic equipment (EEE) - recast, unless otherwise specified as non-compliant.

Please note that some Vishay documentation may still make reference to RoHS Directive 2002/95/EC. We confirm that all the products identified as being compliant to Directive 2002/95/EC conform to Directive 2011/65/EU.

Vishay Intertechnology, Inc. hereby certifies that all its products that are identified as Halogen-Free follow Halogen-Free requirements as per JEDEC JS709A standards. Please note that some Vishay documentation may still make reference to the IEC 61249-2-21 definition. We confirm that all the products identified as being compliant to IEC 61249-2-21 conform to JEDEC JS709A standards.