



Chipsmall Limited consists of a professional team with an average of over 10 year of expertise in the distribution of electronic components. Based in Hongkong, we have already established firm and mutual-benefit business relationships with customers from,Europe,America and south Asia,supplying obsolete and hard-to-find components to meet their specific needs.

With the principle of “Quality Parts,Customers Priority,Honest Operation,and Considerate Service”,our business mainly focus on the distribution of electronic components. Line cards we deal with include Microchip,ALPS,ROHM,Xilinx,Pulse,ON,Everlight and Freescale. Main products comprise IC,Modules,Potentiometer,IC Socket,Relay,Connector.Our parts cover such applications as commercial,industrial, and automotives areas.

We are looking forward to setting up business relationship with you and hope to provide you with the best service and solution. Let us make a better world for our industry!



Contact us

Tel: +86-755-8981 8866 Fax: +86-755-8427 6832

Email & Skype: info@chipsmall.com Web: www.chipsmall.com

Address: A1208, Overseas Decoration Building, #122 Zhenhua RD., Futian, Shenzhen, China



Thermally-Enhanced High Power RF LDMOS FETs 150 W, 420 – 500 MHz

Description

The PTFA041501E and PTFA041501F are 150-watt LDMOS FETs designed for ultra-linear CDMA power amplifier applications. They are available in thermally-enhanced ceramic open-cavity packages. Manufactured with Infineon's advanced LDMOS process, these devices provide excellent thermal performance and superior reliability.

PTFA041501E
Package H-36248-2



PTFA041501F
Package H-37248-2

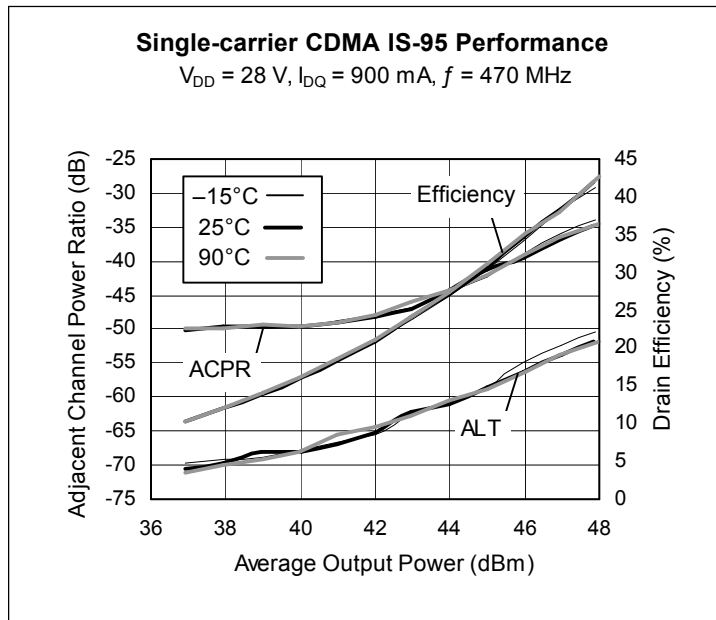

Features

- Broadband internal matching
- Typical CDMA performance at 470 MHz, 28 V
 - Average output power = 60 W
 - Linear Gain = 21 dB
 - Efficiency = 41%
- Typical CW performance, 470 MHz, 28 V
 - Output power at P-1dB = 175 W
 - Efficiency = 62%
- Integrated ESD protection: Human Body Model, Class 1 (minimum)
- Excellent thermal stability
- Low HCI drift
- Capable of handling 10:1 VSWR @ 28 V, 150 W (CW) output power
- Pb-free and RoHS-compliant

RF Characteristics

Single-carrier CDMA IS-95 Measurements (not subject to production test—verified by design/characterization in Infineon test fixture)

$V_{DD} = 28\text{ V}$, $I_{DQ} = 900\text{ mA}$, $P_{OUT} = 60\text{ W}$ average, $f = 470\text{ MHz}$

Characteristic	Symbol	Min	Typ	Max	Unit
Gain	G_{ps}	—	21	—	dB
Drain Efficiency	η_D	—	41	—	%
Adjacent Channel Power Ratio	ACPR	—	-33	—	dB

All published data at $T_{CASE} = 25^\circ\text{C}$ unless otherwise indicated

ESD: Electrostatic discharge sensitive device—observe handling precautions!

RF Characteristics (cont.)

Two-tone Measurements (tested in Infineon test fixture)

$V_{DD} = 28\text{ V}$, $I_{DQ} = 900\text{ mA}$, $P_{OUT} = 150\text{ W PEP}$, $f = 470\text{ MHz}$, tone spacing = 1 MHz

Characteristic	Symbol	Min	Typ	Max	Unit
Gain	G_{ps}	20.0	21.0	—	dB
Drain Efficiency	η_D	45.0	46.5	—	%
Intermodulation Distortion	IMD	—	-29	-28	dBc

DC Characteristics

Characteristic	Conditions	Symbol	Min	Typ	Max	Unit
Drain-Source Breakdown Voltage	$V_{GS} = 0\text{ V}$, $I_{DS} = 10\text{ }\mu\text{A}$	$V_{(BR)DSS}$	65	—	—	V
Drain Leakage Current	$V_{DS} = 28\text{ V}$, $V_{GS} = 0\text{ V}$	I_{DSS}	—	—	1.0	μA
On-State Resistance	$V_{GS} = 10\text{ V}$, $V_{DS} = 0.1\text{ V}$	$R_{DS(on)}$	—	0.07	—	Ω
Operating Gate Voltage	$V_{DS} = 28\text{ V}$, $I_{DQ} = 900\text{ mA}$	V_{GS}	2	2.48	3	V
Gate Leakage Current	$V_{GS} = 10\text{ V}$, $V_{DS} = 0\text{ V}$	I_{GSS}	—	—	1.0	μA

Maximum Ratings

Parameter	Symbol	Value	Unit
Drain-Source Voltage	V_{DSS}	65	V
Gate-Source Voltage	V_{GS}	-0.5 to +12	V
Junction Temperature	T_J	200	$^{\circ}\text{C}$
Storage Temperature Range	T_{STG}	-40 to +150	$^{\circ}\text{C}$
Thermal Resistance ($T_{CASE} = 70^{\circ}\text{C}$, 150 W CW)	$R_{\theta JC}$	0.42	$^{\circ}\text{C/W}$

Ordering Information

Type and Version	Package Type	Package Description	Shipping
PTFA041501E V4	H-36248-2	Thermally-enhanced slotted flange, single-ended	Tray
PTFA041501E V4 R250	H-36248-2	Thermally-enhanced slotted flange, single-ended	Tape & Reel, 250 pcs
PTFA041501F V4	H-37248-2	Thermally-enhanced earless flange, single-ended	Tray
PTFA041501F V4 R250	H-37248-2	Thermally-enhanced earless flange, single-ended	Tape & Reel, 250 pcs

Typical Performance (data taken in a production test fixture)

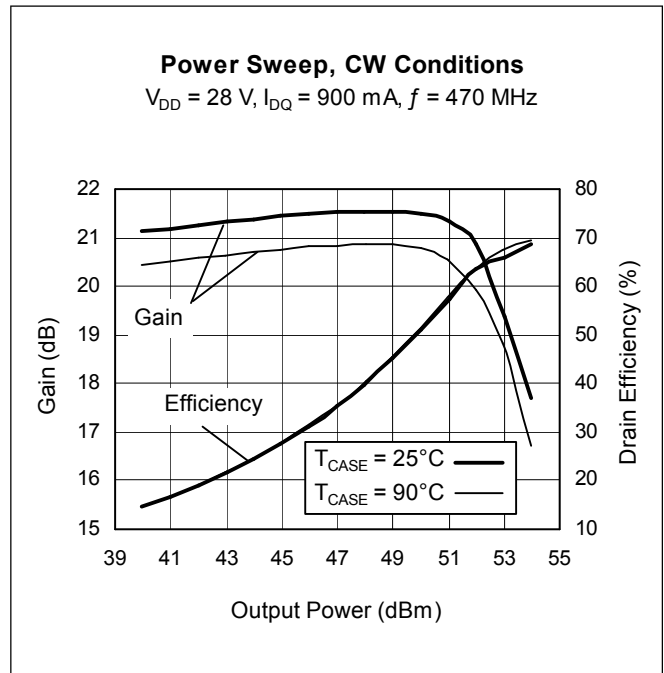
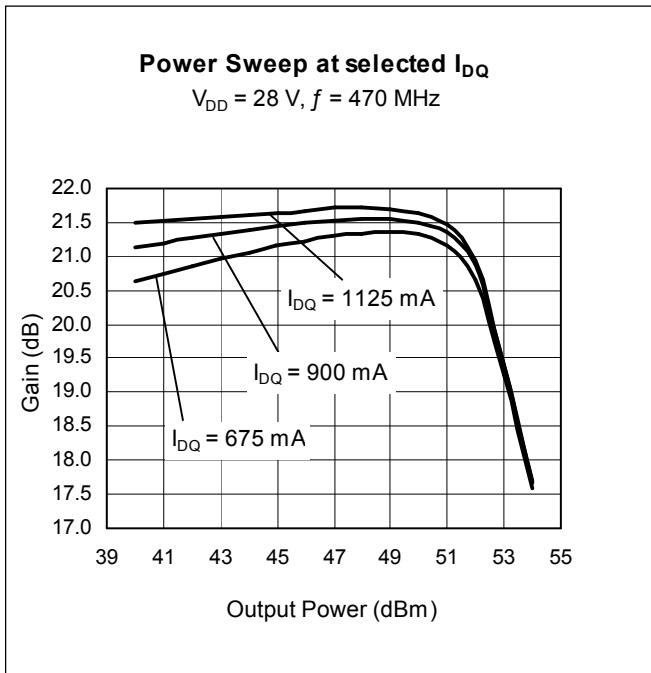
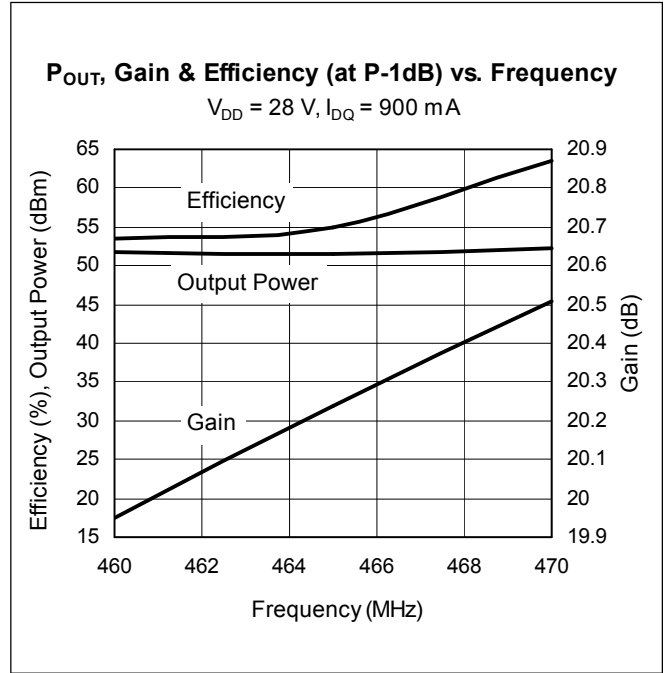
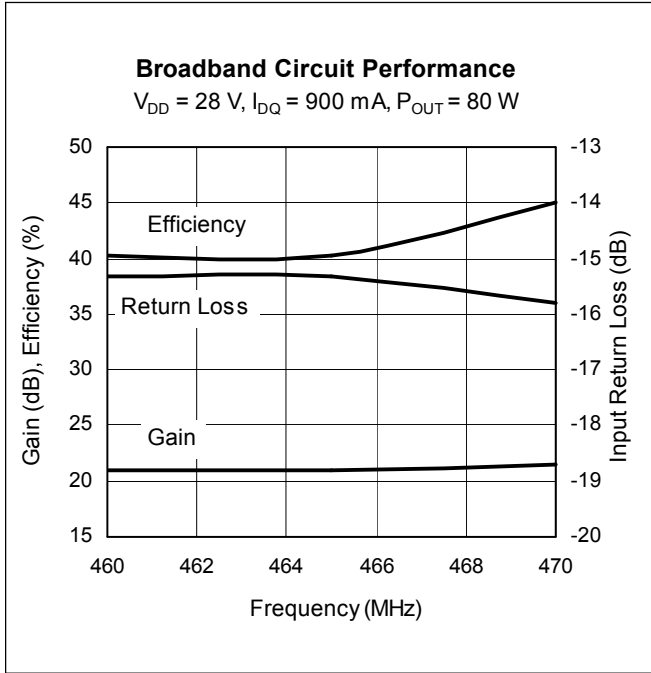

Typical Performance (cont.)

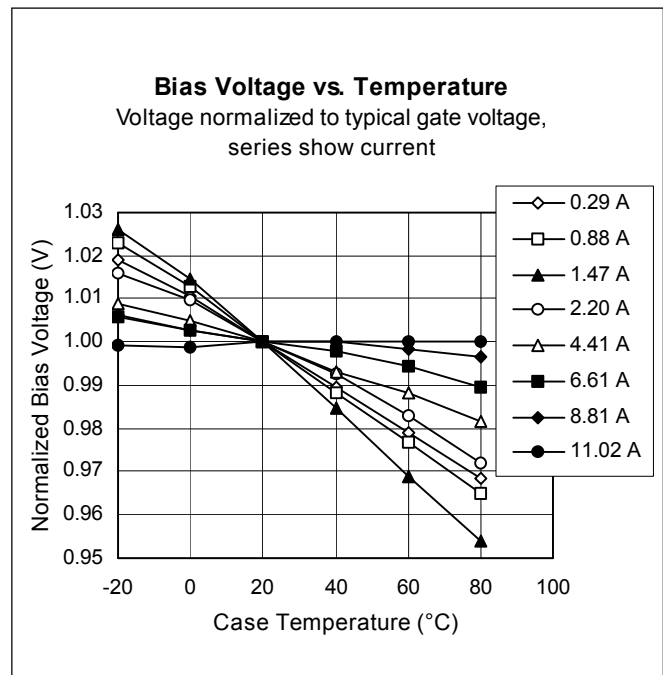
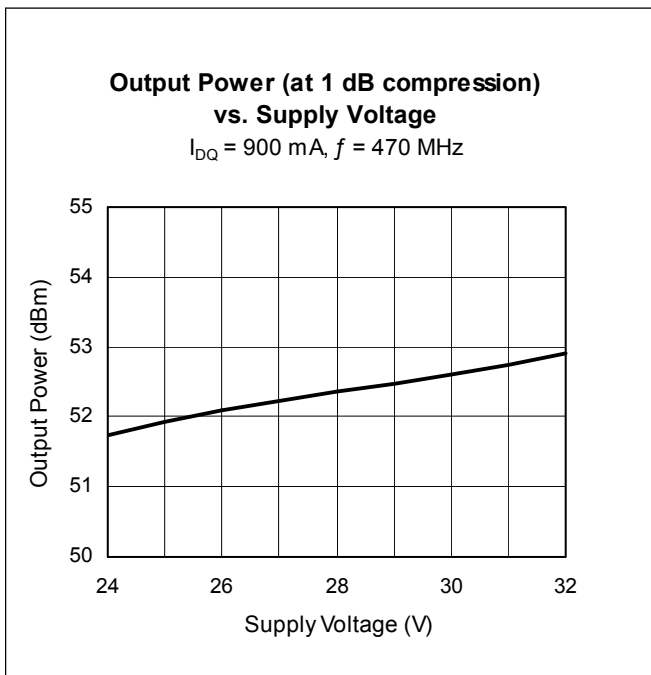
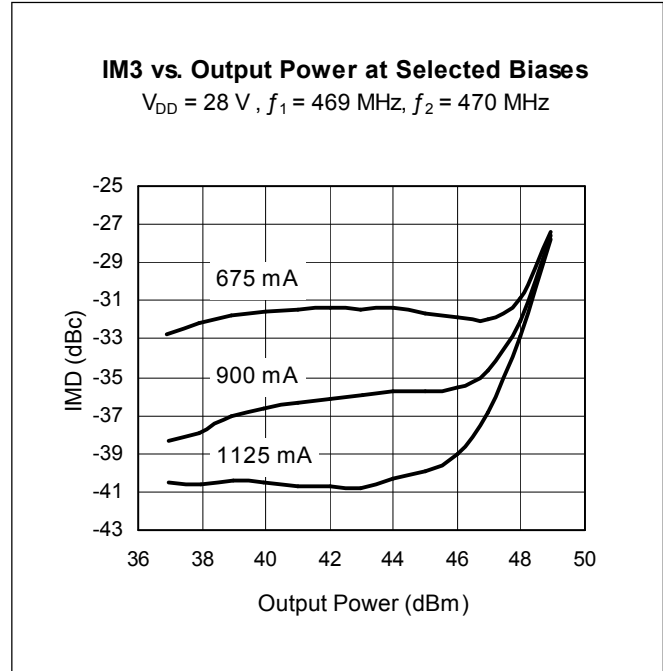
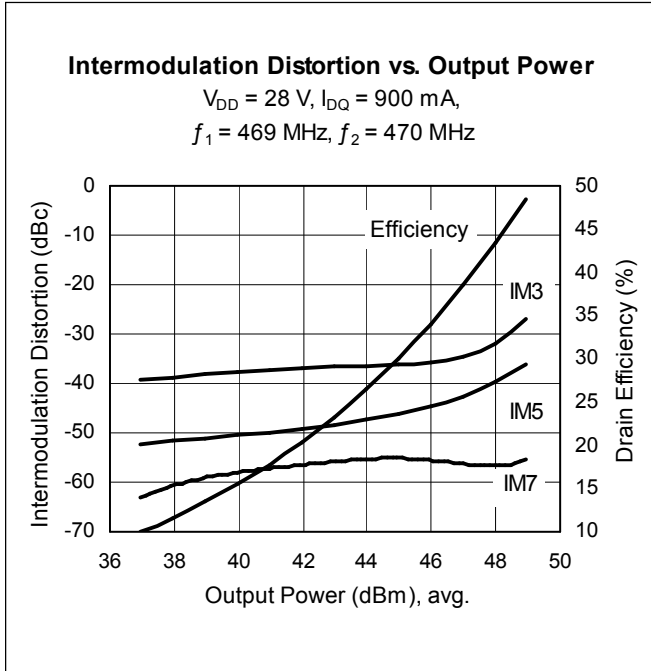

Broadband Circuit Impedance

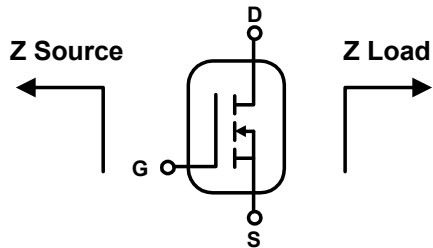

Frequency MHz	Z Source Ω		Z Load Ω	
	R	jX	R	jX
450	0.88	-3.20	1.33	0.22
455	0.84	-3.20	1.35	0.31
460	0.84	-3.10	1.40	0.38
465	0.84	-3.00	1.41	0.47
470	0.83	-2.90	1.44	0.57

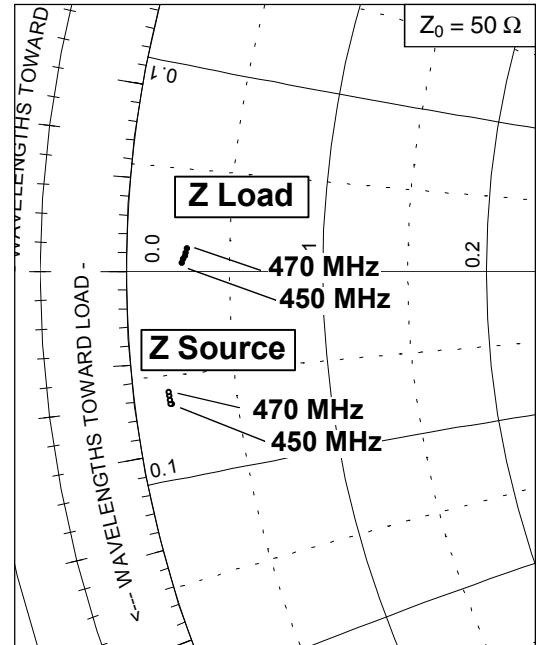

See next page for circuit information

Reference Circuit

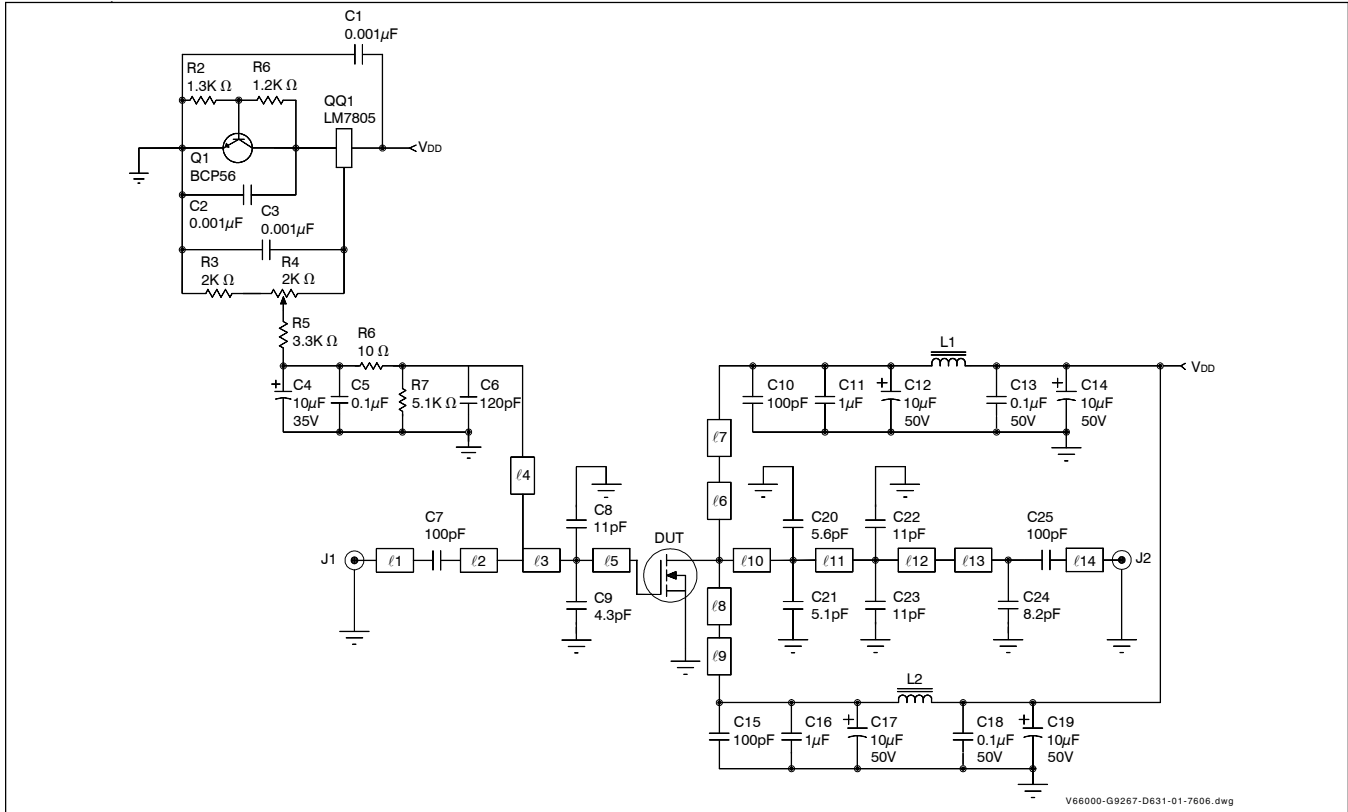

Reference circuit schematic for $f = 460 \text{ MHz}$

Circuit Assembly Information

DUT	PTFA041501E or PTFA041501F	LDMOS Transistor		
PCB	LTN/PTFA041501EF	0.76 mm [.030"] thick, $\epsilon_r = 9.2$	Rogers TMM10	2 oz. copper

Microstrip	Electrical Characteristics at 460 MHz	Dimensions L x W (mm)	Dimensions L x W (in.)
l 1	0.016 λ , 50.69 Ω	4.32 x 0.71	0.170 x 0.028
l 2	0.058 λ , 24.34 Ω	14.22 x 2.54	0.560 x 0.100
l 3	0.097 λ , 4.85 Ω	21.59 x 17.78	0.850 x 0.700
l 4	0.081 λ , 50.69 Ω	21.59 x 0.71	0.850 x 0.280
l 5	0.040 λ , 4.85 Ω	8.89 x 17.78	0.350 x 0.700
l 6	0.158 λ , 37.73 Ω	40.64 x 1.27	1.600 x 0.050
l 7	0.030 λ , 10.94 Ω	5.59 x 7.11	0.220 x 0.280
l 8	0.158 λ , 37.73 Ω	40.64 x 1.27	1.600 x 0.050
l 9	0.030 λ , 10.94 Ω	5.59 x 7.11	0.220 x 0.280
l 10	0.025 λ , 5.58 Ω	5.59 x 15.24	0.220 x 0.600
l 11	0.105 λ , 5.58 Ω	23.62 x 15.24	0.930 x 0.600
l 12	0.006 λ , 5.58 Ω	1.27 x 15.24	0.050 x 0.600
l 13	0.104 λ , 21.37 Ω	25.4 x 3.05	1.000 x 0.120
l 14	0.014 λ , 50.69 Ω	3.81 x 0.71	0.150 x 0.028

Reference Circuit (cont.)

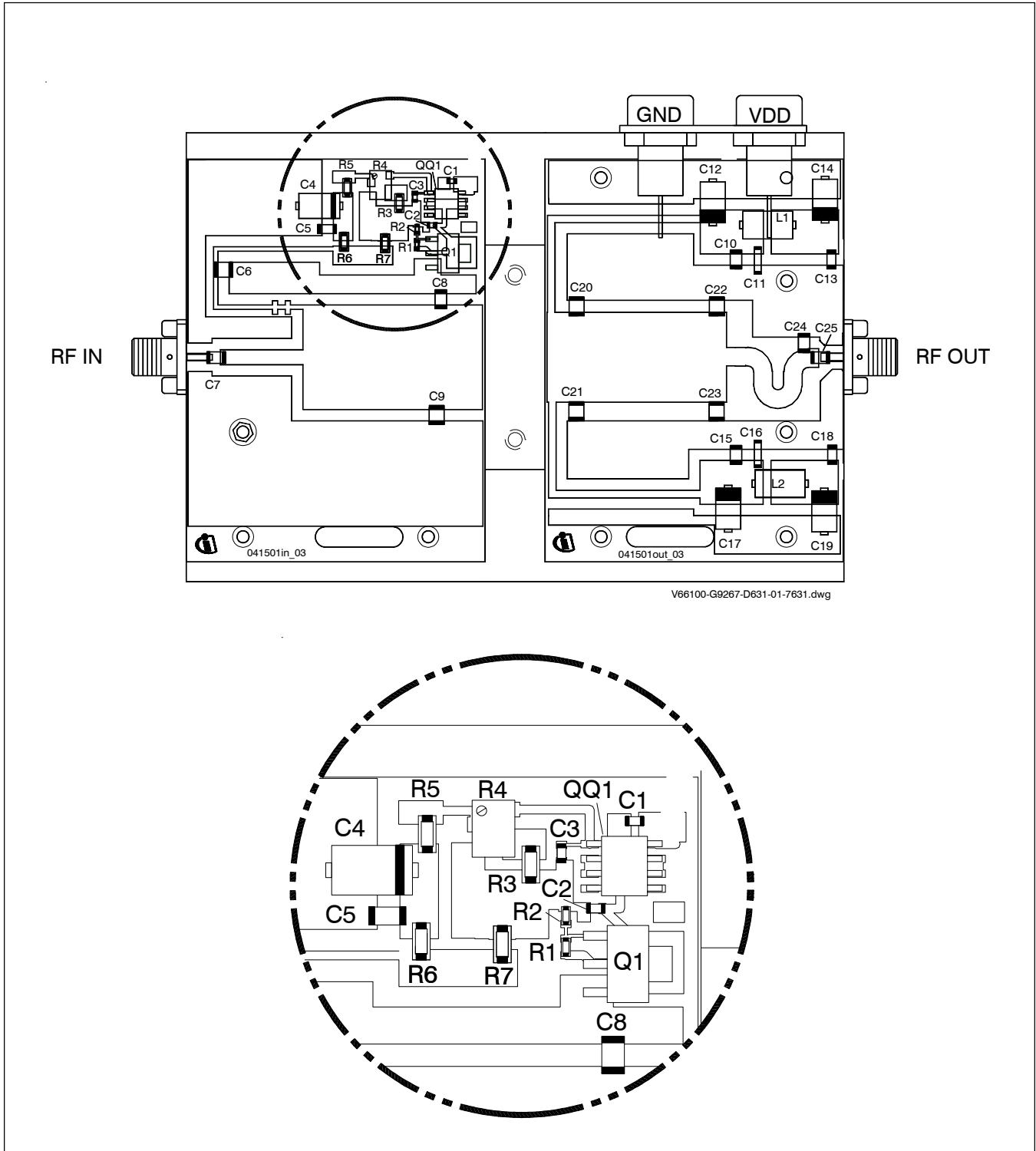

Reference circuit assembly diagram (not to scale). Gerber files for this circuit available on request.

Reference Circuit (cont.)

Component	Description	Suggested Manufacturer	P/N or Comment
C1, C2, C3	Capacitor, 0.001 μ F	Digi-Key	PCC1772CT-ND
C4	Tantalum capacitor, 10 μ F, 35 V	Digi-Key	PCS6106TR-ND
C5, C13, C18	Capacitor, 0.1 μ F	Digi-Key	P4525-ND
C6	Ceramic capacitor, 120 pF	ATC	100B 121
C7, C10, C15, C25	Ceramic capacitor, 100 pF	ATC	100B 101
C8, C22, C23	Ceramic capacitor, 11 pF	ATC	100B 110
C9	Ceramic capacitor, 4.3 pF	ATC	100B 4R3
C11, C16	Capacitor, 1.0 μ F	ATC	920C105
C12, C14, C17, C19	Capacitor, 10 μ F, 50 V	Garrett Electronics	TPS106K050R0400
C20	Ceramic capacitor, 5.6 pF	ATC	100B 5R6
C21	Ceramic capacitor, 5.1 pF	ATC	100B 5R1
C24	Ceramic capacitor, 8.2 pF	ATC	100B 8R2
L1, L2	Ferrite, 6 mm	Ferroxcube	53/3/4.6-452
Q1	Transistor	Infineon Technologies	BCP56
QQ1	Voltage regulator	National Semiconductor	LM7805
R1	Chip resistor, 1.2k ohms	Digi-Key	P1.2KGCT-ND
R2	Chip resistor, 1.3k ohms	Digi-Key	P1.3KGCT-ND
R3	Chip resistor, 2k ohms	Digi-Key	P2.0KECT-ND
R4	Potentiometer, 2k ohms	Digi-Key	3224W-202ETR-ND
R5	Chip resistor, 3.3k ohms	Digi-Key	P3.3KECT-ND
R6	Chip resistor, 10 ohms	Digi-Key	P10ECT-ND
R7	Chip resistor, 5.1k ohms	Digi-Key	P5.1KECT-ND

Package Outline Specifications

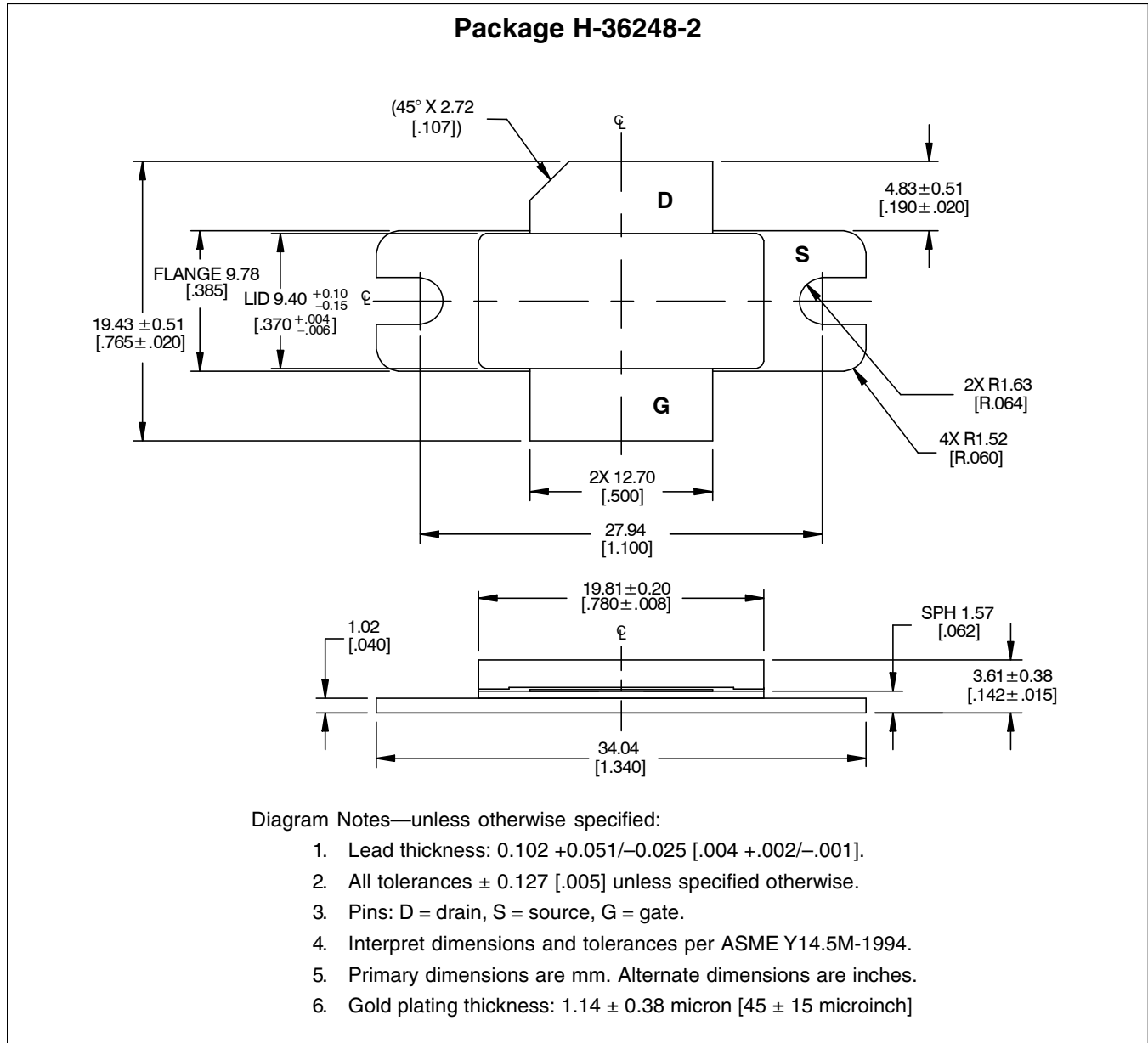

Package Outline Specifications (cont.)

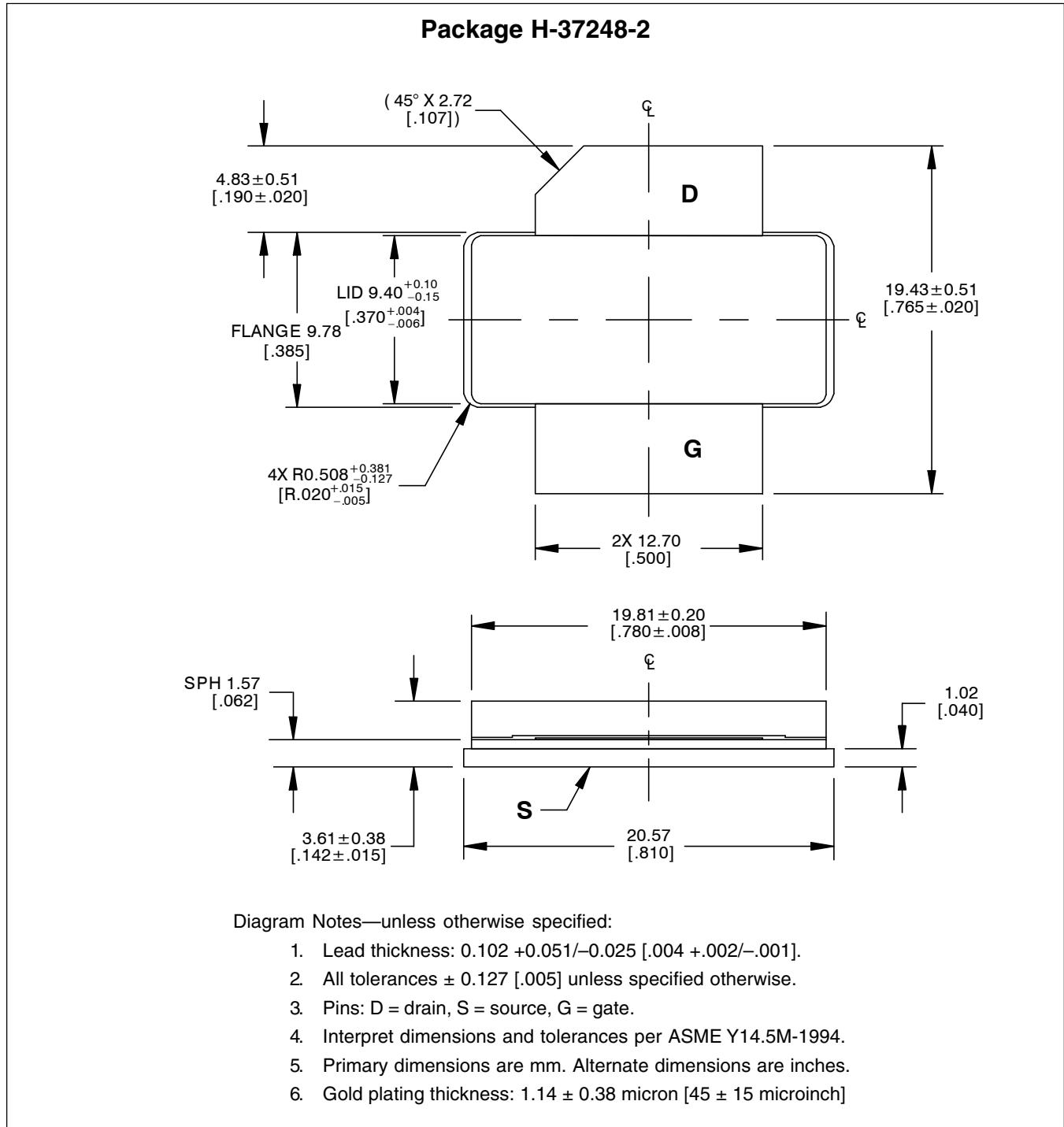

Find the latest and most complete information about products and packaging at the Infineon Internet page
<http://www.infineon.com/rfpower>

Revision History: 2010-01-20

Data Sheet

Previous Version: none

Page	Subjects (major changes since last revision)
6, 9, 10	Minor cosmetic changes only

We Listen to Your Comments

Any information within this document that you feel is wrong, unclear or missing at all?
 Your feedback will help us to continuously improve the quality of this document.
 Please send your proposal (including a reference to this document) to:

highpowerRF@infineon.com

To request other information, contact us at:
 +1 877 465 3667 (1-877-GO-LDMOS) USA
 or +1 408 776 0600 International

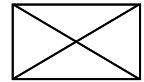
**Edition 2010-01-20**

Published by
Infineon Technologies AG
81726 Munich, Germany

© 2009 Infineon Technologies AG
All Rights Reserved.

Legal Disclaimer

The information given in this document shall in no event be regarded as a guarantee of conditions or characteristics. With respect to any examples or hints given herein, any typical values stated herein and/or any information regarding the application of the device, Infineon Technologies hereby disclaims any and all warranties and liabilities of any kind, including without limitation, warranties of non-infringement of intellectual property rights of any third party.

Information

For further information on technology, delivery terms and conditions and prices, please contact the nearest Infineon Technologies Office (www.infineon.com/rfpower).

Warnings

Due to technical requirements, components may contain dangerous substances. For information on the types in question, please contact the nearest Infineon Technologies Office.

Infineon Technologies components may be used in life-support devices or systems only with the express written approval of Infineon Technologies, if a failure of such components can reasonably be expected to cause the failure of that life-support device or system or to affect the safety or effectiveness of that device or system. Life support devices or systems are intended to be implanted in the human body or to support and/or maintain and sustain and/or protect human life. If they fail, it is reasonable to assume that the health of the user or other persons may be endangered.