



Chipsmall Limited consists of a professional team with an average of over 10 year of expertise in the distribution of electronic components. Based in Hongkong, we have already established firm and mutual-benefit business relationships with customers from,Europe,America and south Asia,supplying obsolete and hard-to-find components to meet their specific needs.

With the principle of “Quality Parts,Customers Priority,Honest Operation,and Considerate Service”,our business mainly focus on the distribution of electronic components. Line cards we deal with include Microchip,ALPS,ROHM,Xilinx,Pulse,ON,Everlight and Freescale. Main products comprise IC,Modules,Potentiometer,IC Socket,Relay,Connector.Our parts cover such applications as commercial,industrial, and automotives areas.

We are looking forward to setting up business relationship with you and hope to provide you with the best service and solution. Let us make a better world for our industry!



Contact us

Tel: +86-755-8981 8866 Fax: +86-755-8427 6832

Email & Skype: info@chipsmall.com Web: www.chipsmall.com

Address: A1208, Overseas Decoration Building, #122 Zhenhua RD., Futian, Shenzhen, China



Thermally-Enhanced High Power RF LDMOS FETs 150 W, 1930 – 1990 MHz

Description

The PTFB191501E and PTFB191501F are 150-watt LDMOS FETs designed for single- and two-carrier WCDMA and CDMA applications from 1930 to 1990 MHz. Features include input and output matching, and thermally-enhanced, RoHS-compliant package with slotted and earless flanges. Manufactured with Infineon's advanced LDMOS process, these devices provide excellent thermal performance and superior reliability.

PTFB191501E
Package H-36248-2

PTFB191501F
Package H-37248-2

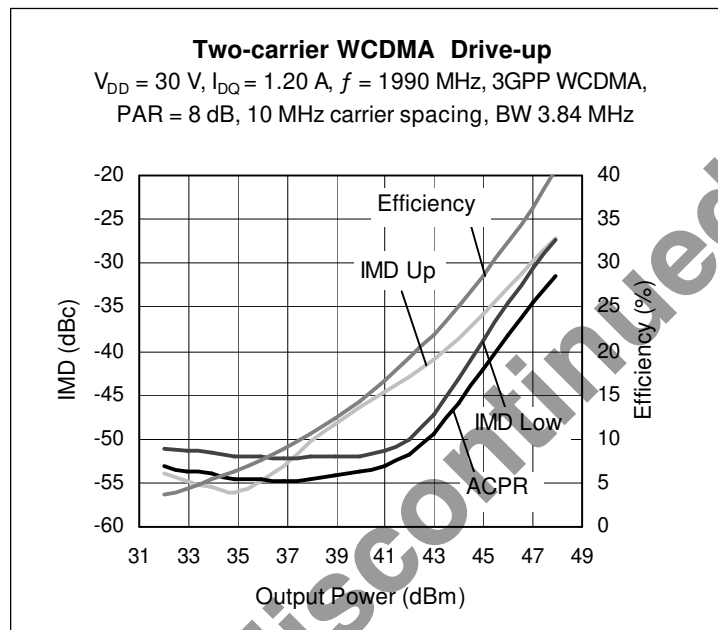
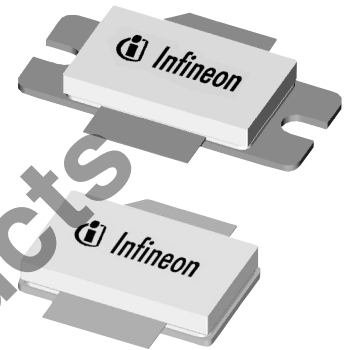

Features

- Broadband internal matching
- Typical two-carrier WCDMA performance at 1990 MHz, 30 V
 - Average output power = 35 W
 - Linear gain = 18 dB
 - Efficiency = 30%
 - Intermodulation distortion = -35 dBc
- Typical CW performance, 1990 MHz, 30 V
 - Output power at P-1dB = 150 W
 - Efficiency = 55%
- Increased negative gate-source voltage range for improved performance in Doherty peaking amplifiers
- Integrated ESD protection: Human Body Model, Class 2 (minimum)
- Excellent thermal stability, low HCI drift
- Capable of handling 10:1 VSWR @ 30 V, 150 W (CW) output power
- Pb-free, RoHS-compliant

RF Characteristics

Two-carrier WCDMA Measurements (not subject to production test—verified by design/characterization in Infineon test fixture)
 $V_{DD} = 30\text{ V}$, $I_{DQ} = 1.2\text{ A}$, $P_{OUT} = 35\text{ W}$ average, $f_1 = 1985\text{ MHz}$, $f_2 = 1995\text{ MHz}$, 3GPP signal, channel bandwidth = 3.84 MHz, peak/average = 8 dB @ 0.01% CCDF

Characteristic	Symbol	Min	Typ	Max	Unit
Gain	G_{ps}	—	18	—	dB
Drain Efficiency	η_D	—	30	—	%
Intermodulation Distortion	IMD	—	-35	—	dBc

All published data at $T_{CASE} = 25^\circ\text{C}$ unless otherwise indicated

ESD: Electrostatic discharge sensitive device—observe handling precautions!

RF Characteristics (cont.)

Two-tone Measurements (tested in Infineon test fixture)

$V_{DD} = 30\text{ V}$, $I_{DQ} = 1.2\text{ A}$, $P_{OUT} = 150\text{ W PEP}$, $f = 1990\text{ MHz}$, tone spacing = 1 MHz

Characteristic	Symbol	Min	Typ	Max	Unit
Gain	G_{ps}	17	18	—	dB
Drain Efficiency	η_D	42	44	—	%
Intermodulation Distortion	IMD	—	-30	-28	dBc

DC Characteristics

Characteristic	Conditions	Symbol	Min	Typ	Max	Unit
Drain-Source Breakdown Voltage	$V_{GS} = 0\text{ V}$, $I_{DS} = 10\text{ mA}$	$V_{(BR)DSS}$	65	—	—	V
Drain Leakage Current	$V_{DS} = 28\text{ V}$, $V_{GS} = 0\text{ V}$	I_{DSS}	—	—	1.0	μA
Drain Leakage Current	$V_{DS} = 63\text{ V}$, $V_{GS} = 0\text{ V}$	I_{DSS}	—	—	10.0	μA
On-State Resistance	$V_{GS} = 10\text{ V}$, $V_{DS} = 0.1\text{ V}$	$R_{DS(on)}$	—	0.08	—	Ω
Operating Gate Voltage	$V_{DS} = 28\text{ V}$, $I_{DQ} = 1.2\text{ A}$	V_{GS}	2.4	2.9	3.4	V
Gate Leakage Current	$V_{GS} = 10\text{ V}$, $V_{DS} = 0\text{ V}$	I_{GSS}	—	—	1.0	μA

Maximum Ratings

Parameter	Symbol	Value	Unit
Drain-Source Voltage	V_{DSS}	65	V
Gate-Source Voltage	V_{GS}	-6 to +10	V
Junction Temperature	T_J	200	$^{\circ}\text{C}$
Storage Temperature Range	T_{STG}	-40 to +150	$^{\circ}\text{C}$
Thermal Resistance ($T_{CASE} = 70^{\circ}\text{C}$, 200 W CW)	$R_{\theta JC}$	0.29	$^{\circ}\text{C/W}$

Ordering Information

Type and Version	Package Type	Package Description	Shipping
PTFB191501E V1	H-36248-2	Thermally-enhanced slotted flange, single-ended	Tray
PTFB191501E V1 R250	H-36248-2	Thermally-enhanced slotted flange, single-ended	Tape & Reel 250 pcs
PTFB191501F V1	H-37248-2	Thermally-enhanced earless flange, single-ended	Tray
PTFB191501F V1 R250	H-37248-2	Thermally-enhanced earless flange, single-ended	Tape & Reel 250 pcs

Typical Performance (data taken in a production test fixture)

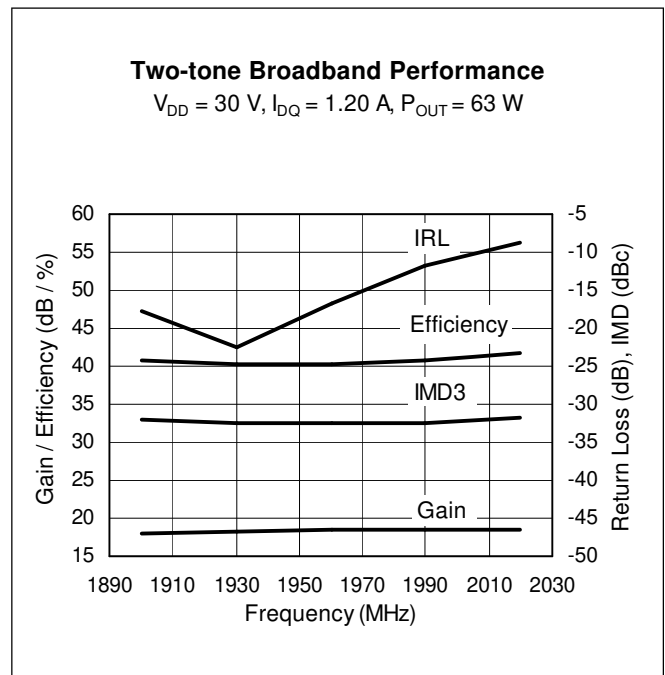
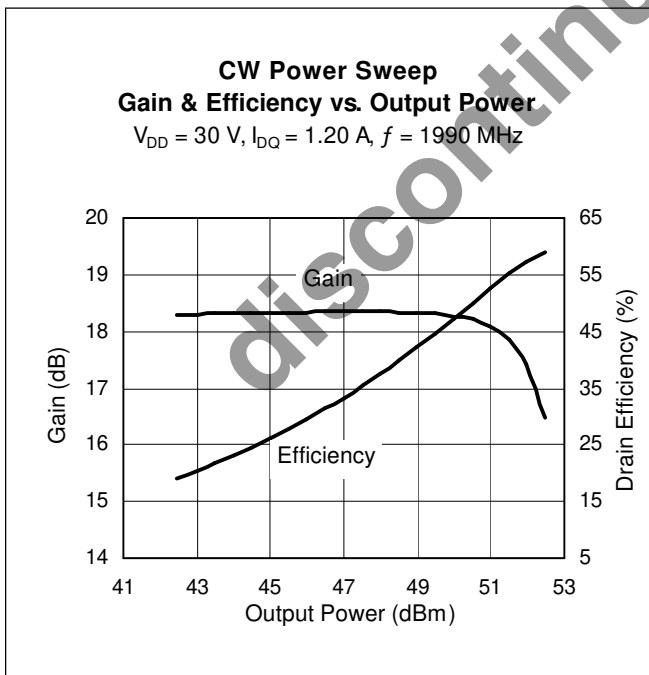
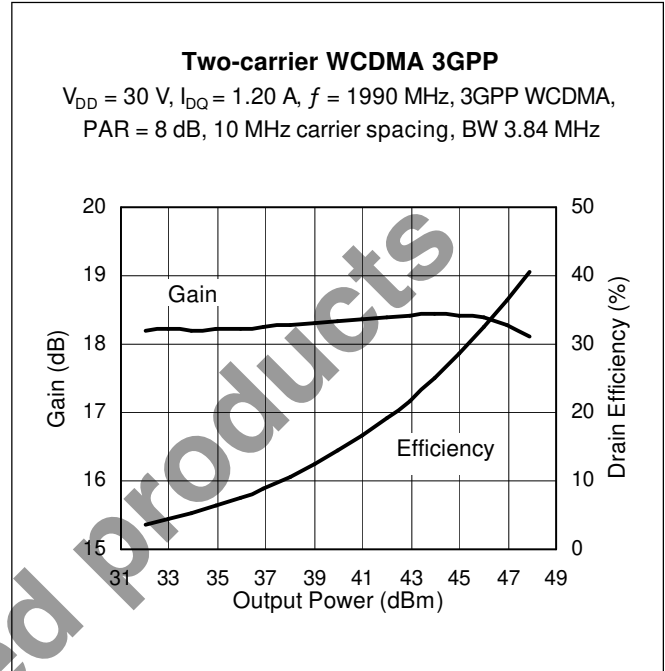
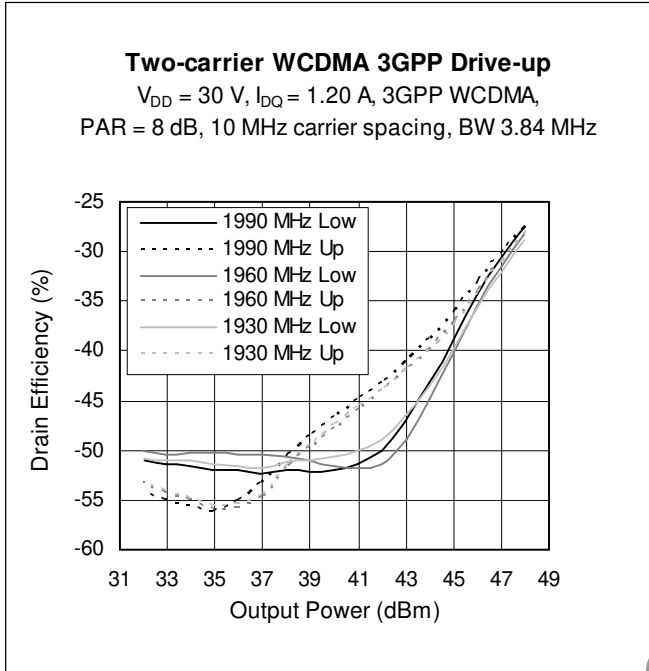

Typical Performance (cont.)

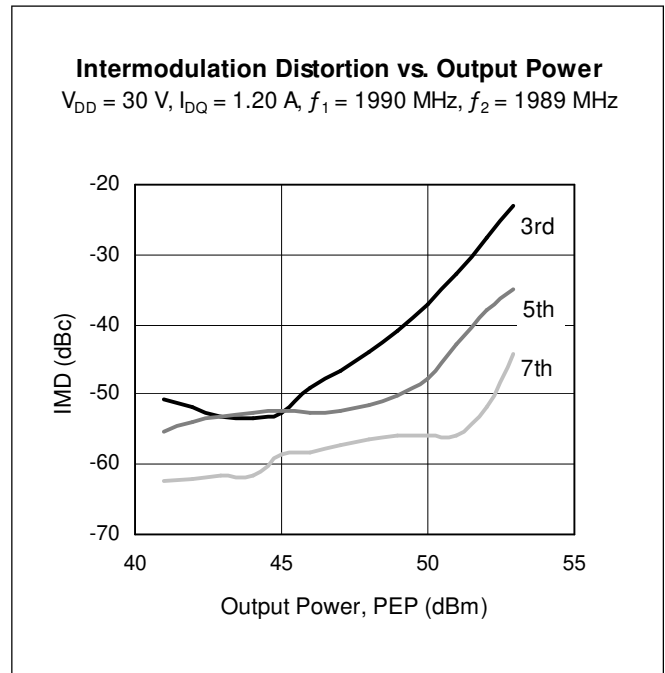
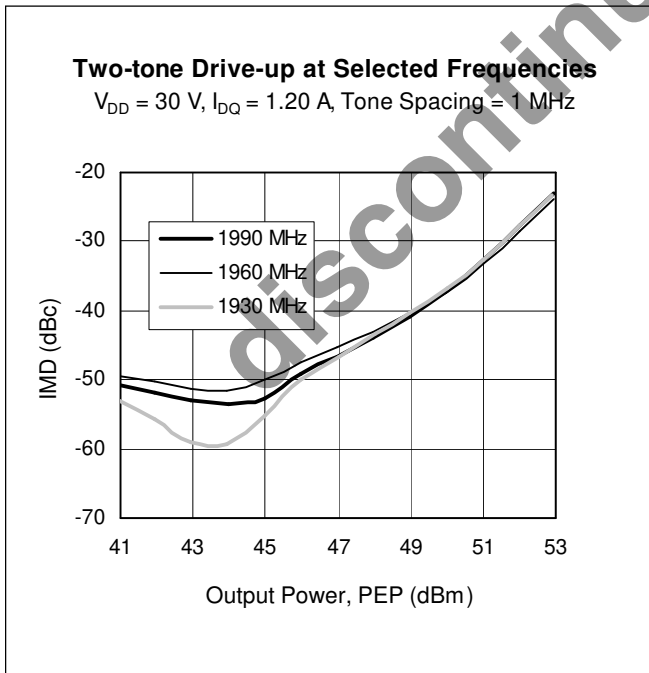
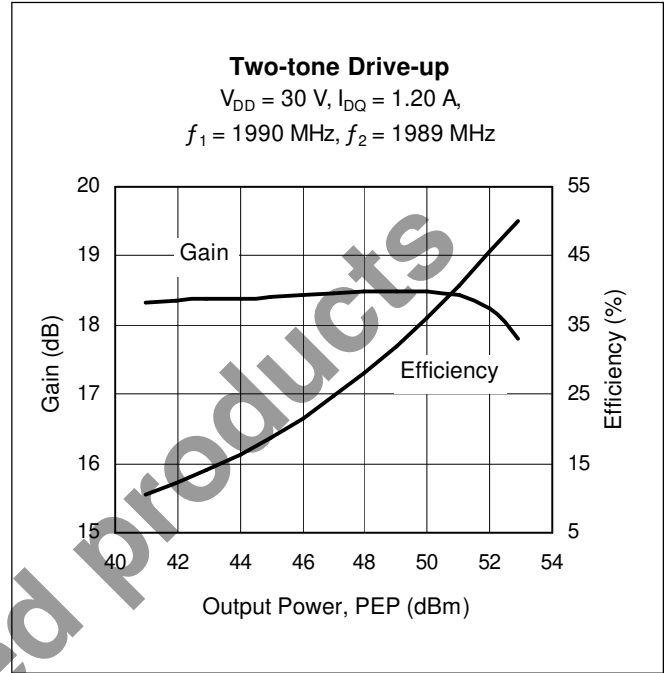
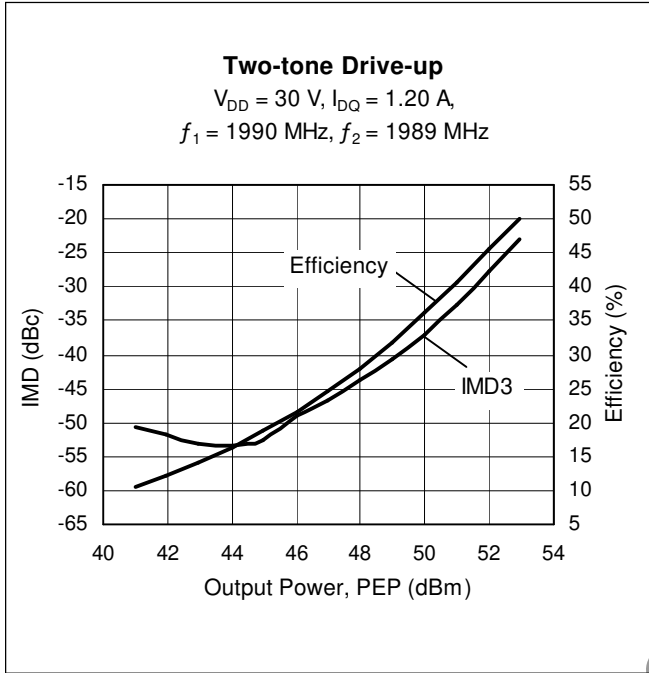

Typical Performance (cont.)

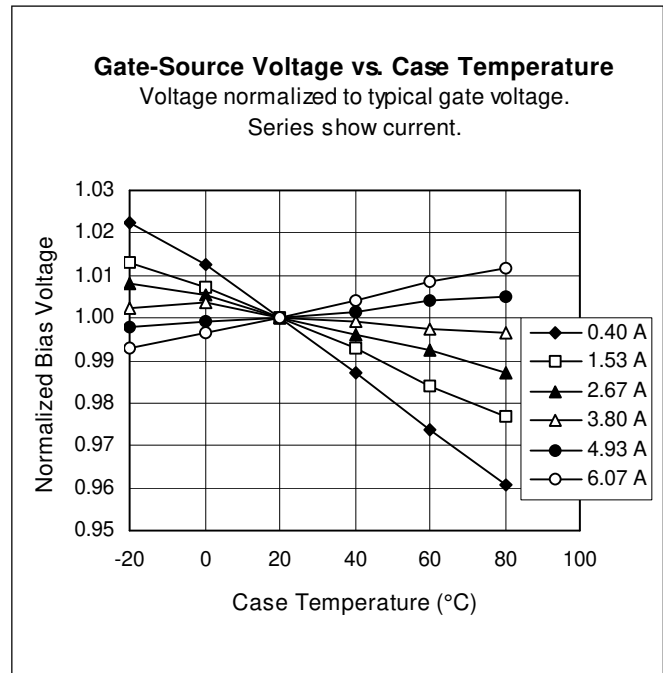
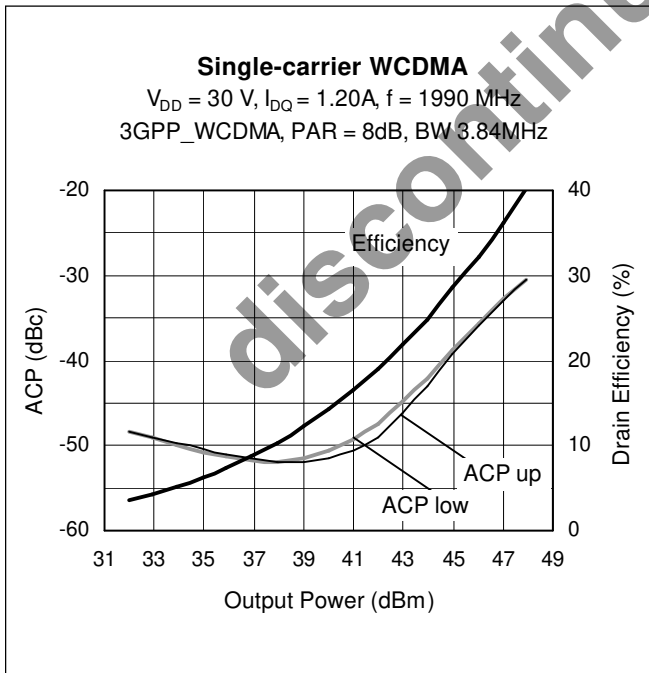
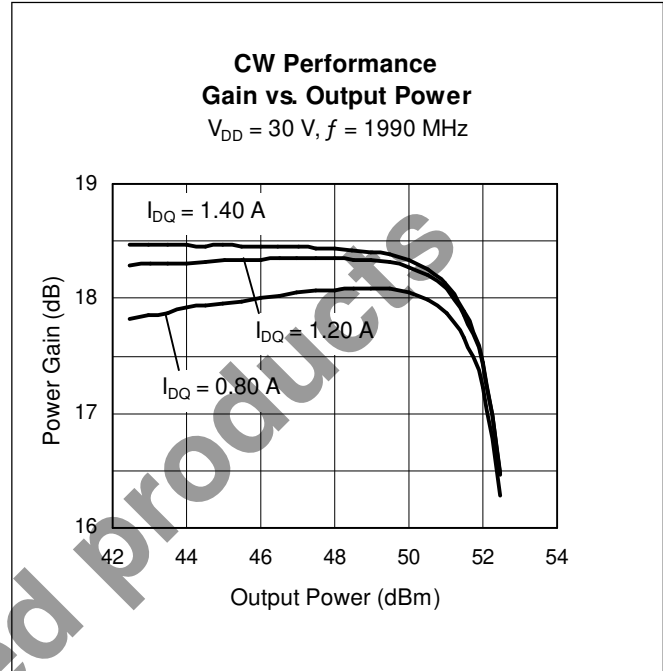
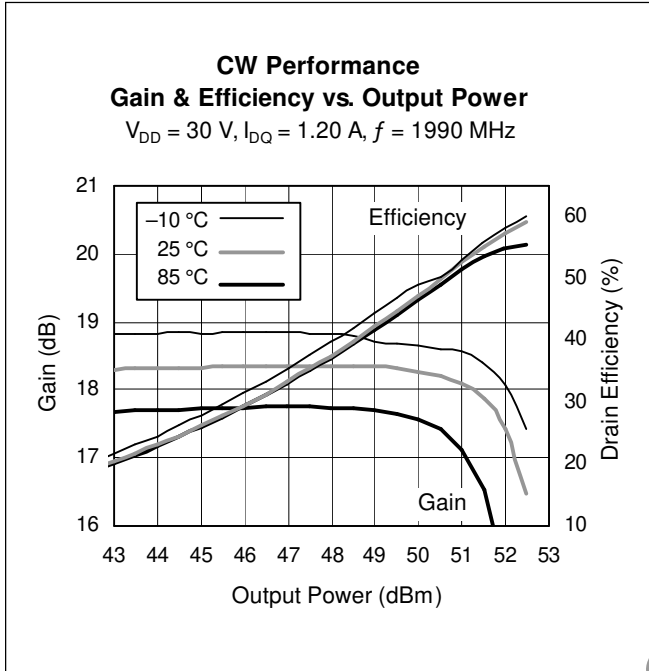

Broadband Circuit Impedance

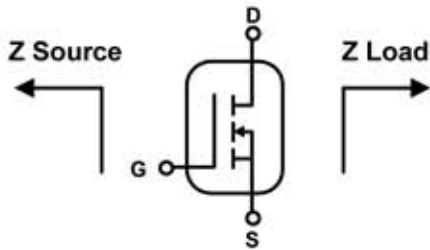

Frequency MHz	Z Source Ω		Z Load Ω	
	R	jX	R	jX
2020	3.91	-8.14	1.01	-3.97
1990	4.03	-8.30	1.01	-4.13
1960	4.15	-8.46	1.03	-4.29
1930	4.28	-8.62	1.04	-4.45
1900	4.42	-8.79	1.06	-4.62

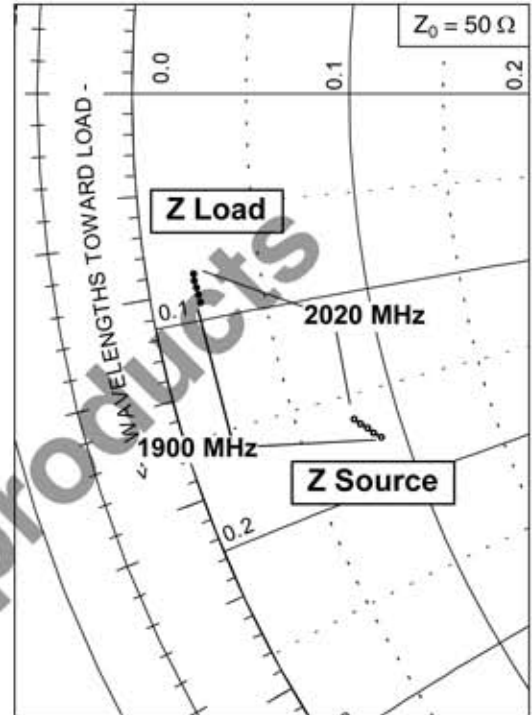

See next page for Reference Circuit information

discontinued products

Reference Circuit

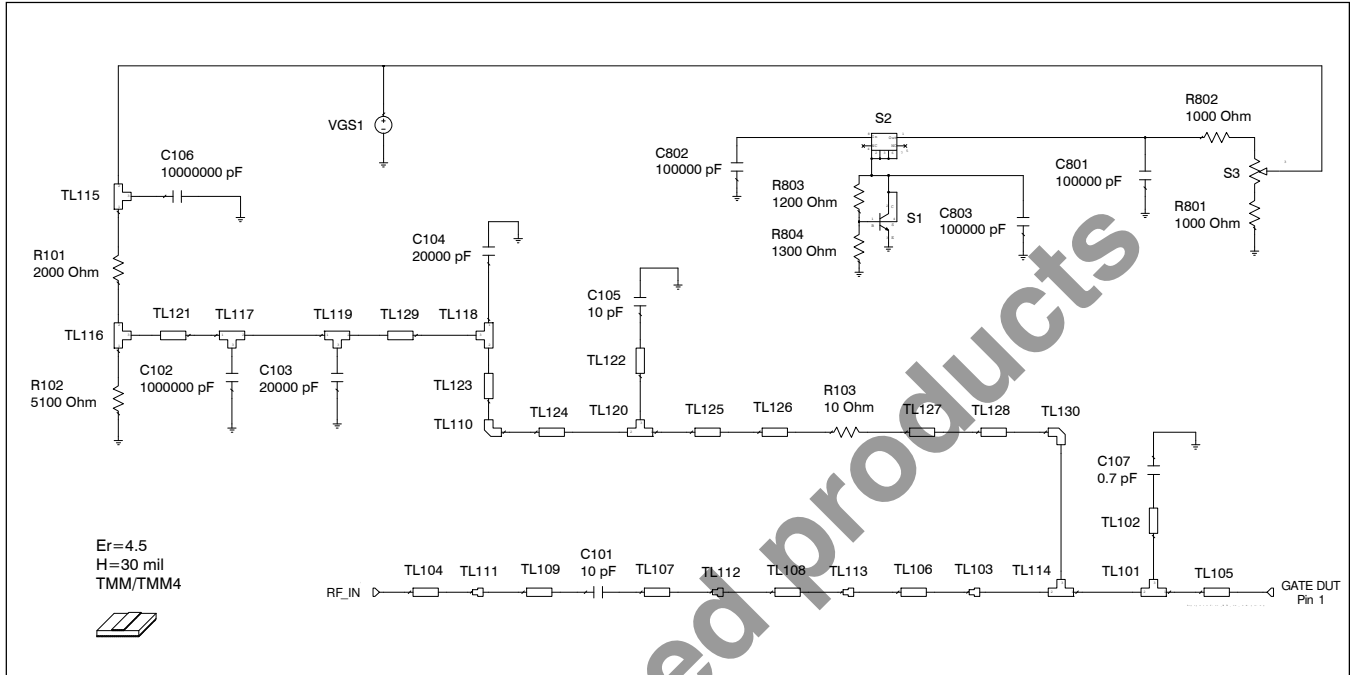

Reference circuit input schematic for $f = 1990$ MHz

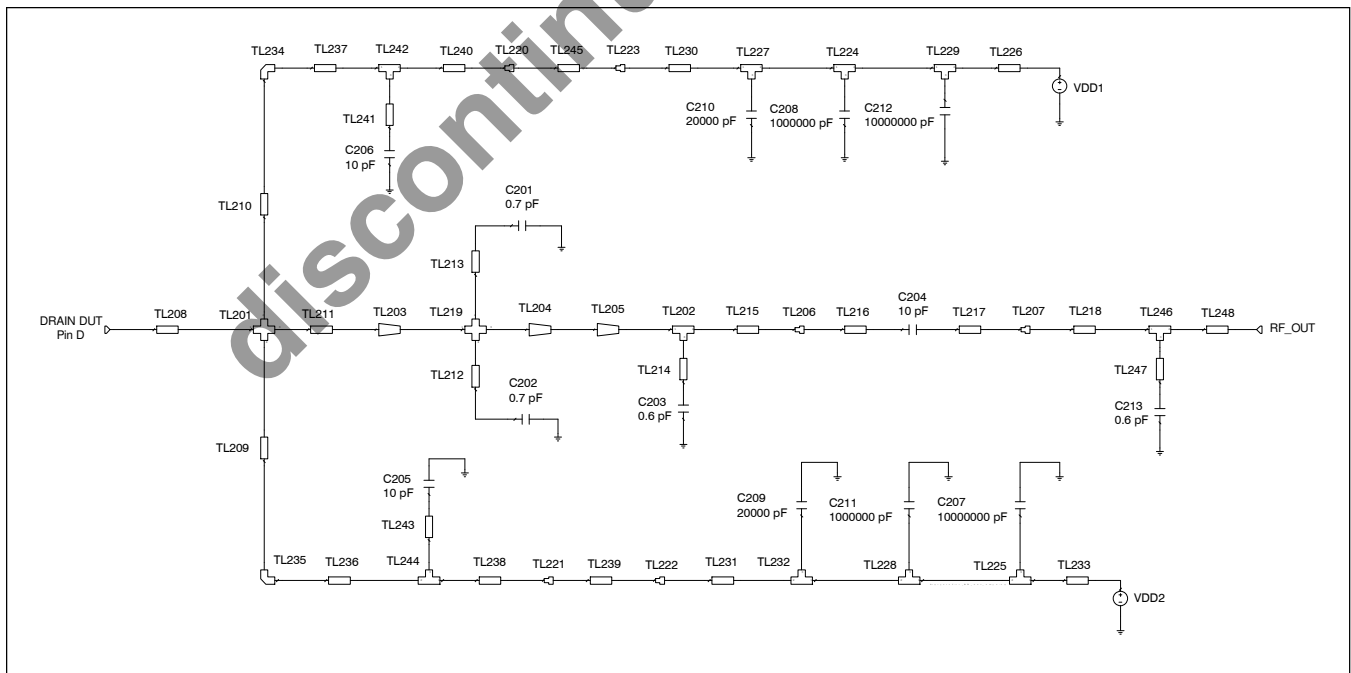

Reference circuit output schematic for $f = 1990$ MHz

Reference Circuit (cont.)

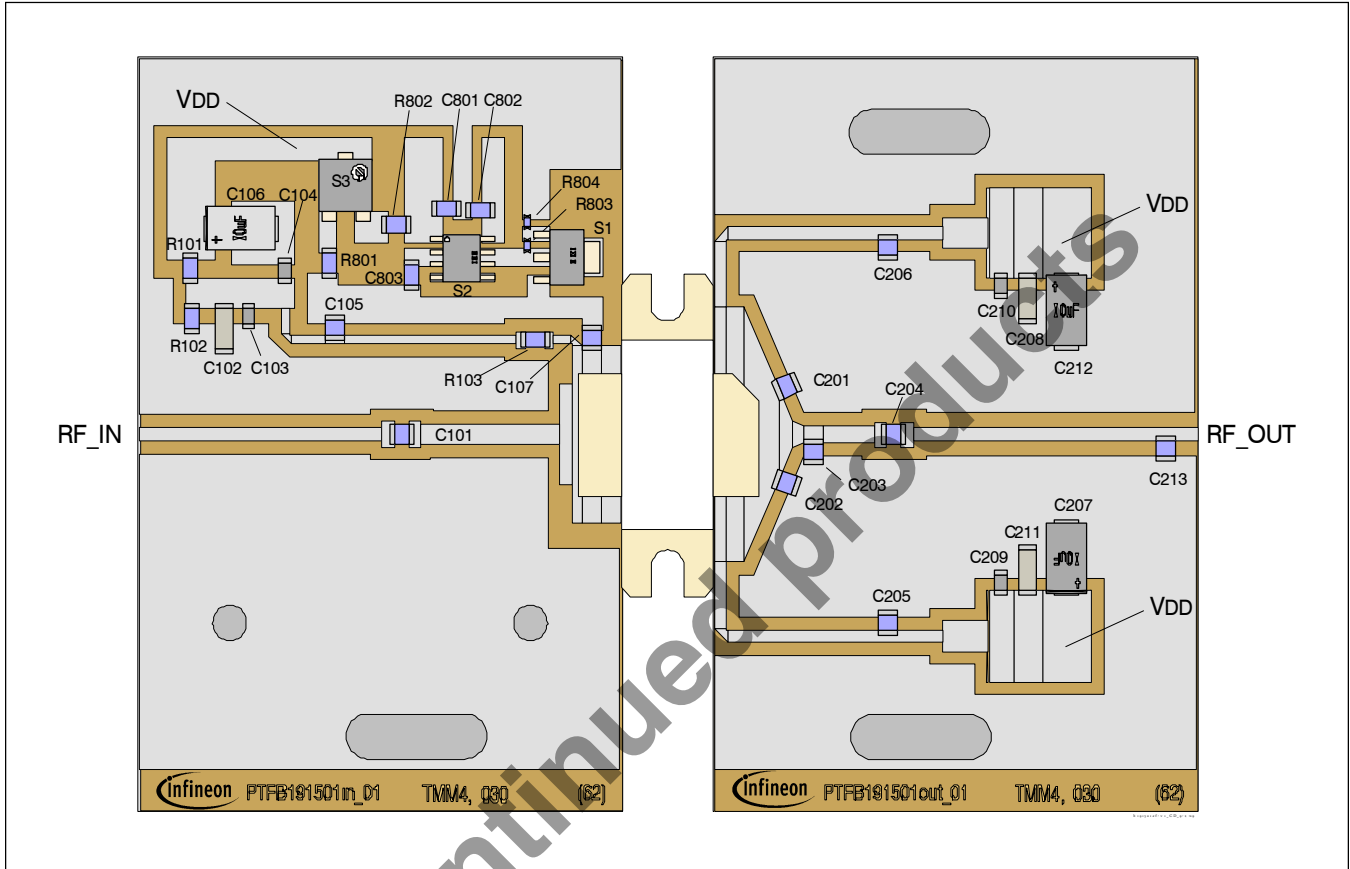

Reference circuit assembly diagram (not to scale)*

Circuit Assembly Information

DUT	PTFB191501E or PTFB191501F	LDMOS Transistor	
INPUT PCB	0.762 mm [.030"] thick, $\epsilon_r = 4.5$	TMM 4	2 oz. copper
OUTPUT PCB	0.762 mm [.030"] thick, $\epsilon_r = 4.5$	TMM 4	2 oz. copper

*Gerber files for this circuit available on request

Reference Circuit (cont.)

Components List

Schematic ID	Component Type	Value	Suggested Manufacturer	Part Number	Comment
Input					
C101	Chip capacitor	10 pF	ATC	ATC100B100FW500XB	
C102	Chip capacitor	1000000 pF	ATC	445-1411-2-ND	
C103, C104	Chip capacitor	20000 pF	ATC	ATC100B102FW500XB	
C105	Chip capacitor	10 pF	ATC	ATC100B100FW500XB	
C106	Capacitor, 10 μ F, 35 V	10000000 pF	Digi-Key	399-1655-2-ND	Tantalum
C107	Chip capacitor	0.7 pF	ATC	ATC100B0R7BW500XB	
C801, C802, C803	Chip capacitor	100000 pF	ATC	PGC104BCT-ND	
R101	Resistor	2000 ohm	Digi-Key	P2.0KECT-ND	
R102	Resistor	5100 ohm	Digi-Key	P5.1KECT-ND	
R103	Resistor	10 ohm	Digi-Key	P100ECT	
R801, R802	Resistor	1000 ohm	Digi-Key	P1.0KECT-ND	
R803	Resistor	1200 ohm	Digi-Key	P1.2KGECT-ND	
R804	Resistor	1300 ohm	Digi-Key	P1.3KGECT-ND	
S1	Transistor		Infineon	BCP56	
S2	Voltage regulator		National Semiconductor	LM7805	
S3	Potentiometer	2k ohms	Digi-Key	3224W-202ECT-ND	
Output					
C201	Chip capacitor	0.7 pF	ATC	100B0R7BW500XB	
C202	Chip capacitor	0.7 pF	ATC	100B0R7BW500XB	
C203	Chip capacitor	0.6 pF	ATC	100B0R6BW500XB	
C204	Chip capacitor	10 pF	ATC	100B100FW500XB	
C205	Chip capacitor	10 pF	ATC	100B100FW500XB	
C206	Chip capacitor	10 pF	ATC	100B100FW500XB	
C207	Capacitor, 10 μ F, 35 V	10000000 pF	Garrett Electronics	TPSE106K050R0400	Tantalum
C208	Chip capacitor	1000000 pF	ATC	445-1411-2-ND	
C209	Chip capacitor	20000 pF	ATC	100B102FW500XB	
C210	Chip capacitor	20000 pF	ATC	100B102FW500XB	
C211	Chip capacitor	1000000 pF	ATC	445-1411-2-ND	
C212	Capacitor, 10 μ F, 35 V	10000000 pF	Garrett Electronics	TPSE106K050R0400	Tantalum
C213	Chip capacitor	0.6 pF	ATC	100B0R6BW500XB	

Reference Circuit (cont.)

Electrical Characteristics at 1990 MHz

Schematic ID	Electrical	1st/4th Dimension	2nd Dimension	3rd Dimension
TL101 MTEE	6.87 Ω 0.241 λ	W1 17.780 mm 700 mils	W2 17.780 mm 700 mils	W3 2.032 mm 80 mils
TL102 MLIN	132.58 Ω 0.000 λ	W 0.025 mm 1 mils	L 0.025 mm 1 mils	
TL103 MSTEP		W1 10.160 mm 400 mils	W2 17.780 mm 700 mils	
TL104 MLIN	50.98 Ω 0.312 λ	W 1.397 mm 55 mils	L 25.527 mm 1005 mils	
TL105 MLIN	6.87 Ω 0.029 λ	W 17.780 mm 700 mils	L 2.159 mm 85 mils	
TL106 MLIN	11.38 Ω 0.019 λ	W 10.160 mm 400 mils	L 1.397 mm 55 mils	
TL107 MLIN	34.60 Ω 0.016 λ	W 2.540 mm 100 mils	L 1.270 mm 50 mils	
TL108 MLIN	40.30 Ω 0.180 λ	W 2.032 mm 80 mils	L 14.478 mm 570 mils	
TL109 MLIN	34.60 Ω 0.016 λ	W 2.540 mm 100 mils	L 1.270 mm 50 mils	
TL110 MBENDAS		W 0.889 mm 35 mils		
TL111 MSTEP		W1 1.397 mm 55 mils	W2 2.540 mm 100 mils	
TL112 MSTEP		W1 2.540 mm 100 mils	W2 2.032 mm 80 mils	
TL113 MSTEP		W1 2.032 mm 80 mils	W2 10.160 mm 400 mils	
TL114 MTEE	6.87 Ω 0.241 λ	W1 17.780 mm 700 mils	W2 17.780 mm 700 mils	W3 0.889 mm 35 mils
TL115 MTEE	20.46 Ω 0.066 λ	W1 5.080 mm 200 mils	W2 5.080 mm 200 mils	W3 6.350 mm 250 mils
TL116 MTEE	53.88 Ω 0.015 λ	W1 1.270 mm 50 mils	W2 1.270 mm 50 mils	W3 3.048 mm 120 mils
TL117 MTEE	30.35 Ω 0.038 λ	W1 3.048 mm 120 mils	W2 3.048 mm 120 mils	W3 2.540 mm 100 mils
TL118 MTEE	40.30 Ω 0.025 λ	W1 2.032 mm 80 mils	W2 2.032 mm 80 mils	W3 3.048 mm 120 mils
TL119 MTEE	30.35 Ω 0.038 λ	W1 3.048 mm 120 mils	W2 3.048 mm 120 mils	W3 2.540 mm 100 mils
TL120 MTEES	65.15 Ω 0.011 λ	W1 0.889 mm 35 mils	W2 0.889 mm 35 mils	W3 2.032 mm 80 mils
TL121 MLIN	30.35 Ω 0.019 λ	W 3.048 mm 120 mils	L 1.524 mm 60 mils	
TL122 MLIN	40.30 Ω 0.000 λ	W 2.032 mm 80 mils	L 0.025 mm 1 mils	
TL123 MLIN	65.15 Ω 0.030 λ	W 0.889 mm 35 mils	L 2.540 mm 100 mils	
TL124 MLIN	65.15 Ω 0.043 λ	W 0.889 mm 35 mils	L 3.556 mm 140 mils	
TL125 MLIN	65.15 Ω 0.216 λ	W 0.889 mm 35 mils	L 18.034 mm 710 mils	
TL126 MLIN	46.07 Ω 0.011 λ	W 1.651 mm 65 mils	L 0.889 mm 35 mils	
TL127 MLIN	46.07 Ω 0.011 λ	W 1.651 mm 65 mils	L 0.889 mm 35 mils	
TL128 MLIN	65.15 Ω 0.023 λ	W 0.889 mm 35 mils	L 1.905 mm 75 mils	
TL129 MLIN	30.35 Ω 0.019 λ	W 3.048 mm 120 mils	L 1.524 mm 60 mils	
TL130 MBENDA		W 0.889 mm 35 mils		

Reference Circuit (cont.)

Electrical Characteristics at 1990 MHz

Schematic ID	Electrical	1st/4th Dimension	2nd Dimension	3rd Dimension
TL201 MCROSS		W1 25.654 mm 1010 mils W4 1.270 mm 50 mils	W2 1.270 mm 50 mils	W3 25.654 mm 1010 mils
TL202 MTEE	132.58 Ω 0.000 λ	W1 1.778 mm 70 mils	W2 1.778 mm 70 mils	W3 2.032 mm 80 mils
TL203 MTAPER	4.88 Ω 0.026 λ 5.388 Ω	W1 25.654 mm 1010 mils	W2 9.144 mm 360 mils	L 3.683 mm 145 mils
TL204 MTAPER	53.88 Ω 0.082 λ 53.88 Ω	W1 9.144 mm 360 mils	W2 2.794 mm 110 mils	L 1.270 mm 50 mils
TL205 MTAPER	53.88 Ω 0.082 λ 132.58 Ω	W1 2.794 mm 110 mils	W2 1.778 mm 70 mils	L 1.270 mm 50 mils
TL206 MSTEP		W1 1.778 mm 70 mils	W2 2.540 mm 100 mils	
TL207 MSTEP		W1 2.540 mm 100 mils	W2 1.397 mm 55 mils	
TL208 MLIN	43.96 Ω 0.031 λ	W 25.654 mm 1010 mils	L 0.025 mm 1 mils	
TL209 MLIN	32.33 Ω 0.022 λ	W 1.270 mm 50 mils	L 6.731 mm 265 mils	
TL210 MLIN	12.48 Ω 0.037 λ	W 1.270 mm 50 mils	L 6.731 mm 265 mils	
TL211 MLIN	4.88 Ω 0.125 λ	W 25.654 mm 1010 mils	L 1.905 mm 75 mils	
TL212 MLIN	43.96 Ω 0.022 λ	W 0.025 mm 1 mils	L 0.025 mm 1 mils	
TL213 MLIN	132.58 Ω 0.000 λ	W 0.025 mm 1 mils	L 0.025 mm 1 mils	
TL214 MLIN	40.30 Ω 0.000 λ	W 2.032 mm 80 mils	L 0.025 mm 1 mils	
TL215 MLIN	43.96 Ω 0.066 λ	W 1.778 mm 70 mils	L 5.334 mm 210 mils	
TL216 MLIN	34.60 Ω 0.016 λ	W 2.540 mm 100 mils	L 1.270 mm 50 mils	
TL217 MLIN	34.60 Ω 0.016 λ	W 2.540 mm 100 mils	L 1.270 mm 50 mils	
TL218 MLIN	50.98 Ω 0.310 λ	W 1.397 mm 55 mils	L 25.400 mm 1000 mils	
TL219 MCROSS		W1 9.144 mm 360 mils W4 0.025 mm 1 mils	W2 0.025 mm 1 mils	W3 9.144 mm 360 mils
TL220 MSTEP\$		W1 1.270 mm 50 mils	W2 3.048 mm 120 mils	
TL221 MSTEP\$		W1 1.270 mm 50 mils	W2 3.048 mm 120 mils	
TL222 MSTEP\$		W1 3.048 mm 120 mils	W2 9.144 mm 360 mils	
TL223 MSTEP\$		W1 3.048 mm 120 mils	W2 9.144 mm 360 mils	
TL224 MTEE	30.35 Ω 0.059 λ	W1 9.144 mm 360 mils	W2 9.144 mm 360 mils	W3 3.048 mm 120 mils
TL225 MTEE	53.88 Ω 0.057 λ	W1 9.144 mm 360 mils	W2 9.144 mm 360 mils	W3 5.080 mm 200 mils
TL226 MLIN	40.30 Ω 0.000 λ	W 9.144 mm 360 mils	L 0.127 mm 5 mils	
TL227 MTEE	40.30 Ω 0.000 λ	W1 9.144 mm 360 mils	W2 9.144 mm 360 mils	W3 2.540 mm 100 mils
TL228 MTEE	30.35 Ω 0.059 λ	W1 9.144 mm 360 mils	W2 9.144 mm 360 mils	W3 3.048 mm 120 mils
TL229 MTEE	12.48 Ω 0.002 λ	W1 9.144 mm 360 mils	W2 9.144 mm 360 mils	W3 5.080 mm 200 mils
TL230 MLIN	12.48 Ω 0.002 λ	W 9.144 mm 360 mils	L 0.127 mm 5 mils	
TL231 MLIN	12.48 Ω 0.002 λ	W 9.144 mm 360 mils	L 0.127 mm 5 mils	
TL232 MTEE	12.48 Ω 0.002 λ	W1 9.144 mm 360 mils	W2 9.144 mm 360 mils	W3 2.540 mm 100 mils
TL233 MLIN	53.88 Ω 0.037 λ	W 9.144 mm 360 mils	L 0.127 mm 5 mils	

Reference Circuit (cont.)

Electrical Characteristics at 1990 MHz

Schematic ID	Electrical	1st/4th Dimension	2nd Dimension	3rd Dimension
TL234 MBENDAS		W 1.270 mm 50 mils		
TL235 MBENDAS		W 1.270 mm 50 mils		
TL236 MLIN	53.88 Ω 0.015 λ	W 1.270 mm 50 mils	L 15.748 mm 620 mils	
TL237 MLIN	53.88 Ω 0.015 λ	W 1.270 mm 50 mils	L 15.748 mm 620 mils	
TL238 MLIN	12.48 Ω 0.121 λ	W 1.270 mm 50 mils	L 4.699 mm 185 mils	
TL239 MLIN	12.48 Ω 0.121 λ	W 3.048 mm 120 mils	L 4.699 mm 185 mils	
TL240 MLIN	12.48 Ω 0.121 λ	W 1.270 mm 50 mils	L 4.699 mm 185 mils	
TL241 MLIN	12.48 Ω 0.121 λ	W 2.032 mm 80 mils	L 0.025 mm 1 mils	
TL242 MTEES	12.48 Ω 0.121 λ	W1 1.270 mm 50 mils	W2 1.270 mm 50 mils	W3 2.032 mm 80 mils
TL243 MLIN	12.48 Ω 0.121 λ	W 2.032 mm 80 mils	L 0.025 mm 1 mils	
TL244 MTEES	30.35 Ω 0.115 λ	W1 1.270 mm 50 mils	W2 1.270 mm 50 mils	W3 2.032 mm 80 mils
TL245 MLIN	40.30 Ω 0.000 λ	W 3.048 mm 120 mils	L 4.699 mm 185 mils	
TL246 MTEE	50.98 Ω 0.017 λ	W1 1.397 mm 55 mils	W2 1.397 mm 55 mils	W3 2.032 mm 80 mils
TL247 MLIN	50.98 Ω 0.028 λ	W 2.032 mm 80 mils	L 0.025 mm 1 mils	
TL248 MLIN	50.98 Ω 0.028 λ	W 1.397 mm 55 mils	L 2.261 mm 89 mils	

See next page for Package Outline Specifications

discontinued products

Package Outline Specifications

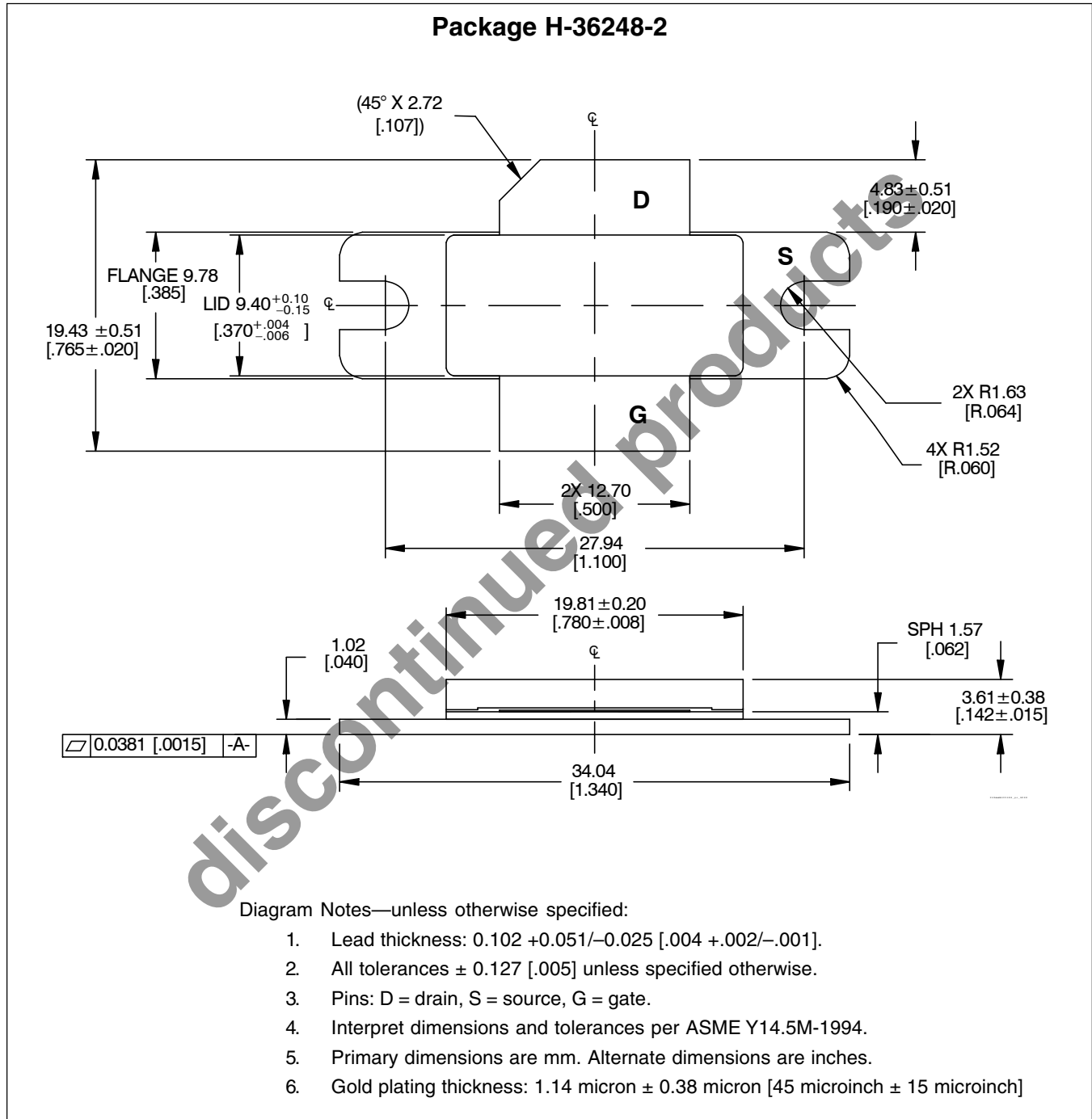

Package Outline Specifications (cont.)

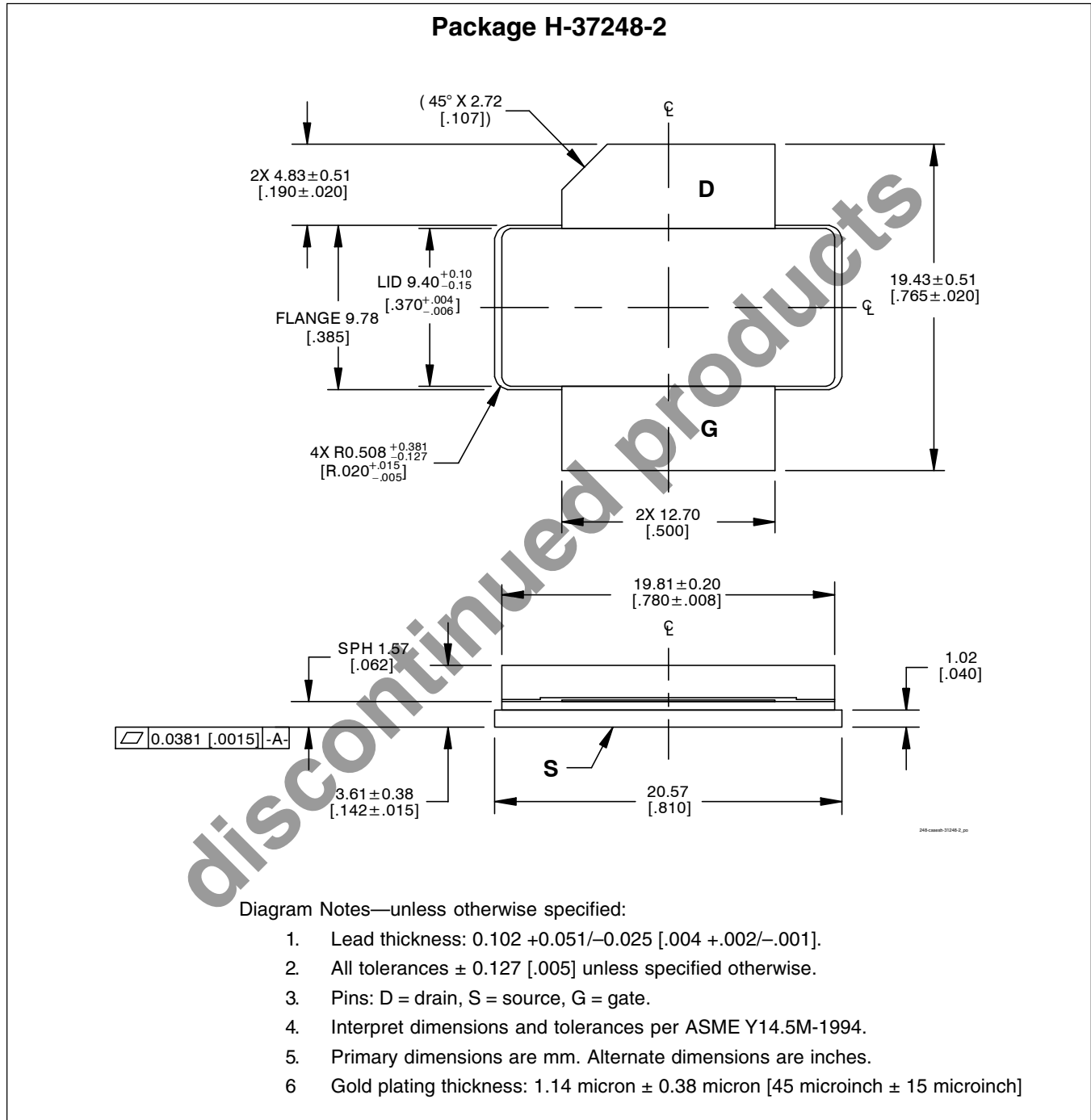

Find the latest and most complete information about products and packaging at the Infineon Internet page
<http://www.infineon.com/rfpower>

Revision History: 2015-01-14

Data Sheet

Previous Version: 2009-09-09, Data Sheet

Page	Subjects (major changes since last revision)
All	Products discontinued. Please see PD Notes : PD_215_14.

We Listen to Your Comments

Any information within this document that you feel is wrong, unclear or missing at all?
Your feedback will help us to continuously improve the quality of this document.
Please send your proposal (including a reference to this document) to:

highpowerRF@infineon.com

To request other information, contact us at:
+1 877 465 3667 (1-877-GO-LDMOS) USA
or +1 408 776 0600 International

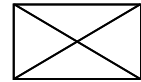

Edition 2015-01-14

Published by

Infineon Technologies AG
81726 Munich, Germany

© 2009 Infineon Technologies AG
All Rights Reserved.

Legal Disclaimer

The information given in this document shall in no event be regarded as a guarantee of conditions or characteristics. With respect to any examples or hints given herein, any typical values stated herein and/or any information regarding the application of the device, Infineon Technologies hereby disclaims any and all warranties and liabilities of any kind, including without limitation, warranties of non-infringement of intellectual property rights of any third party.

Information

For further information on technology, delivery terms and conditions and prices, please contact the nearest Infineon Technologies Office (www.infineon.com/rfpower).

Warnings

Due to technical requirements, components may contain dangerous substances. For information on the types in question, please contact the nearest Infineon Technologies Office.

Infineon Technologies components may be used in life-support devices or systems only with the express written approval of Infineon Technologies, if a failure of such components can reasonably be expected to cause the failure of that life-support device or system or to affect the safety or effectiveness of that device or system. Life support devices or systems are intended to be implanted in the human body or to support and/or maintain and sustain and/or protect human life. If they fail, it is reasonable to assume that the health of the user or other persons may be endangered.