



Chipsmall Limited consists of a professional team with an average of over 10 year of expertise in the distribution of electronic components. Based in Hongkong, we have already established firm and mutual-benefit business relationships with customers from,Europe,America and south Asia,supplying obsolete and hard-to-find components to meet their specific needs.

With the principle of “Quality Parts,Customers Priority,Honest Operation,and Considerate Service”,our business mainly focus on the distribution of electronic components. Line cards we deal with include Microchip,ALPS,ROHM,Xilinx,Pulse,ON,Everlight and Freescale. Main products comprise IC,Modules,Potentiometer,IC Socket,Relay,Connector.Our parts cover such applications as commercial,industrial, and automotives areas.

We are looking forward to setting up business relationship with you and hope to provide you with the best service and solution. Let us make a better world for our industry!



Contact us

Tel: +86-755-8981 8866 Fax: +86-755-8427 6832

Email & Skype: info@chipsmall.com Web: www.chipsmall.com

Address: A1208, Overseas Decoration Building, #122 Zhenhua RD., Futian, Shenzhen, China



16V PicoTLynx™ 4A: Non-Isolated DC-DC Power Modules

8Vdc –16Vdc input; 0.6Vdc to 8.0Vdc output; 4A Output Current

**TUNABLE
LOOP™**
A LINEAGE POWER TRADEMARK



RoHS Compliant

Applications

- Distributed power architectures
- Intermediate bus voltage applications
- Telecommunications equipment
- Servers and storage applications
- Networking equipment
- Industrial equipment

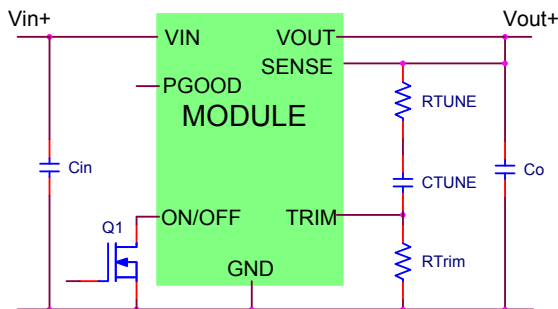

Description

The 16V PicoTLynx™ 4A power modules are non-isolated dc-dc converters that can deliver up to 4A of output current. These modules operate over a wide range of input voltage ($V_{IN} = 8\text{Vdc}-16\text{Vdc}$) and provide a precisely regulated output voltage from 0.59Vdc to 8.0Vdc, programmable via an external resistor. Features include remote On/Off, adjustable output voltage, over current and over temperature protection. A new feature, the Tunable Loop™, allows the user to optimize the dynamic response of the converter to match the load with reduced amount of output capacitance leading to savings on cost and PWB area.

* UL is a registered trademark of Underwriters Laboratories, Inc.

† CSA is a registered trademark of Canadian Standards Association.

‡ VDE is a trademark of Verband Deutscher Elektrotechniker e.V.

** ISO is a registered trademark of the International Organization of Standards

Features

- Compliant to RoHS EU Directive 2002/95/EC
- Compatible in a Pb-free or SnPb reflow environment
- Wide Input voltage range (8Vdc-16Vdc)
- Output voltage programmable from 0.59Vdc to 8.0Vdc via external resistor
- Tunable Loop™ to optimize dynamic output voltage response
- Remote sense
- Power Good signal
- Fixed switching frequency
- Output overcurrent protection (non-latching)
- Overtemperature protection
- Remote On/Off
- Ability to sink and source current
- Cost efficient open frame design
- Small size: 12.2 mm x 12.2 mm x 7.25 mm (0.48 in x 0.48 in x 0.29 in)
- Wide operating temperature range (-40°C to 85°C)
- UL* Recognized to UL60950-1, CAN/CSA† C22.2 No. 60950-1-03, and EN60950-1(VDE‡ 0805-1) Licensed
- ISO** 9001 and ISO 14001 certified manufacturing facilities

16V PicoTLynx™ 4A: Non-Isolated DC-DC Power Modules

8Vdc –16Vdc input; 0.6Vdc to 8.0Vdc output; 4A Output Current

Absolute Maximum Ratings

Stresses in excess of the absolute maximum ratings can cause permanent damage to the device. These are absolute stress ratings only, functional operation of the device is not implied at these or any other conditions in excess of those given in the operations sections of the data sheet. Exposure to absolute maximum ratings for extended periods can adversely affect the device reliability.

Parameter	Device	Symbol	Min	Max	Unit
Input Voltage Up to 10 seconds	All	V_{IN}	-0.3	18	Vdc
Operating Ambient Temperature (see Thermal Considerations section)	All	T_A	-40	85	°C
Storage Temperature	All	T_{stg}	-55	125	°C

Electrical Specifications

Unless otherwise indicated, specifications apply over all operating input voltage, resistive load, and temperature conditions.

Parameter	Device	Symbol	Min	Typ	Max	Unit
Operating Input Voltage	All	V_{IN}	8.0	—	16.0	Vdc
Maximum Input Current ($V_{IN}=8V$ to 16V, $I_O=I_{O,max}$)	All	$I_{IN,max}$			6.5	Adc
Input No Load Current ($V_{IN} = 16.0Vdc$, $I_O = 0$, module enabled)	$V_{O,set} = 0.6 Vdc$	$I_{IN,No load}$		18		mA
	$V_{O,set} = 8.0Vdc$	$I_{IN,No load}$		96.1		mA
Input Stand-by Current ($V_{IN} = 16.0Vdc$, module disabled)	All	$I_{IN,stand-by}$		1.2		mA
Inrush Transient	All	I^2t			1	A ² s
Input Reflected Ripple Current, peak-to-peak (5Hz to 20MHz, 1 μ H source impedance; $V_{IN} = 0$ to 16V, $I_O = I_{O,max}$; See Test Configurations)	All			50		mAp-p
Input Ripple Rejection (120Hz)	All			-46		dB

CAUTION: This power module is not internally fused. An input line fuse must always be used.

This power module can be used in a wide variety of applications, ranging from simple standalone operation to an integrated part of sophisticated power architecture. To preserve maximum flexibility, internal fusing is not included; however, to achieve maximum safety and system protection, always use an input line fuse. The safety agencies require a fast-acting fuse with a maximum rating of 6 A (see Safety Considerations section). Based on the information provided in this data sheet on inrush energy and maximum dc input current, the same type of fuse with a lower rating can be used. Refer to the fuse manufacturer's data sheet for further information.

16V PicoTLynx™ 4A: Non-Isolated DC-DC Power Modules

8Vdc –16Vdc input; 0.6Vdc to 8.0Vdc output; 4A Output Current

Electrical Specifications (continued)

Parameter	Device	Symbol	Min	Typ	Max	Unit
Output Voltage Set-point (with 0.5% tolerance for external resistor used to set output voltage)	All	$V_{O,set}$	-1.5		+1.5	% $V_{O,set}$
Output Voltage (Over all operating input voltage, resistive load, and temperature conditions until end of life)	All	$V_{O,set}$	-2.5	—	+2.5	% $V_{O,set}$
Adjustment Range (selected by an external resistor) (Some output voltages may not be possible depending on the input voltage – see Feature Descriptions Section)	All	V_O	0.59		8.0	Vdc
Remote Sense Range	All				0.5	Vdc
Output Regulation (for $V_O \geq 2.5Vdc$)						
Line ($V_{IN}=V_{IN,min}$ to $V_{IN,max}$)	All			—	+0.4	% $V_{O,set}$
Load ($I_O=I_{O,min}$ to $I_{O,max}$)	All			—	10mV	% $V_{O,set}$
Output Regulation (for $V_O < 2.5Vdc$)						
Line ($V_{IN}=V_{IN,min}$ to $V_{IN,max}$)	All			—	10	mV
Load ($I_O=I_{O,min}$ to $I_{O,max}$)	All			—	5	mV
Temperature ($T_{ref}=T_{A,min}$ to $T_{A,max}$)	All			—	0.4	% $V_{O,set}$
Remote Sense Range	All				0.5	V
Output Ripple and Noise on nominal output ($V_{IN}=V_{IN,nom}$ and $I_O=I_{O,min}$ to $I_{O,max}$, $C_o = 0.1\mu F // 10\mu F$ ceramic capacitors)						
Peak-to-Peak (5Hz to 20MHz bandwidth)	All		—	90	100	mV _{pk-pk}
RMS (5Hz to 20MHz bandwidth)	All			36	38	mV _{rms}
External Capacitance ¹						
Without the Tunable Loop™						
ESR $\geq 1\text{ m}\Omega$	All	$C_{O,max}$	0	—	22	μF
With the Tunable Loop™						
ESR $\geq 0.15\text{ m}\Omega$	All	$C_{O,max}$	0	—	470	μF
ESR $\geq 10\text{ m}\Omega$	All	$C_{O,max}$	0	—	3000	μF
Output Current (in either sink or source mode)	All	I_O	0		4	A _{dc}
Output Current Limit Inception (Hiccup Mode) (current limit does not operate in sink mode)	All	$I_{O,lim}$		200		% $I_{O,max}$
Output Short-Circuit Current ($V_O \leq 250\text{mV}$) (Hiccup Mode)	All	$I_{O,s/c}$		200		mA _{rms}
Efficiency $V_{IN}=12Vdc$, $T_A=25^\circ C$ $I_O=I_{O,max}$, $V_O=V_{O,set}$						
	$V_{O,set}=0.6Vdc$	η		74.2		%
	$V_{O,set}=1.2Vdc$	η		83.7		%
	$V_{O,set}=1.8Vdc$	η		87.7		%
	$V_{O,set}=2.5Vdc$	η		90.2		%
	$V_{O,set}=3.3Vdc$	η		91.7		%
	$V_{O,set}=5.0Vdc$	η		93.7		%
	$V_{O,set}=6.5Vdc$	η		94.9		%
	$V_{O,set}=8.0Vdc$	η		96.1		%
Switching Frequency	All	f_{sw}	—	600	—	kHz

¹External capacitors may require using the new Tunable Loop™ feature to ensure that the module is stable as well as getting the best transient response. See the Tunable Loop™ section for details.

16V PicoTLynx™ 4A: Non-Isolated DC-DC Power Modules

8Vdc –16Vdc input; 0.6Vdc to 8.0Vdc output; 4A Output Current

General Specifications

Parameter	Min	Typ	Max	Unit
Calculated MTBF ($I_o=0.8I_{o,max}$, $T_A=40^\circ\text{C}$) Telcordia Issue 2 Method 1 Case 3		14,353,850		Hours
Weight	—	1.92 (0.0677)	—	g (oz.)

Feature Specifications

Unless otherwise indicated, specifications apply over all operating input voltage, resistive load, and temperature conditions. See Feature Descriptions for additional information.

Parameter	Device	Symbol	Min	Typ	Max	Unit
On/Off Signal Interface ($V_{IN}=V_{IN,min}$ to $V_{IN,max}$; open collector or equivalent, Signal referenced to GND) Device is with suffix "4" – Positive Logic (See Ordering Information)						
Logic High (Module ON)						
Input High Current	All	I_{IH}	—	—	10	μA
Input High Voltage	All	V_{IH}	3.5	—	$V_{IN,max}$	V
Logic Low (Module OFF)						
Input Low Current	All	I_{IL}	—	—	1	mA
Input Low Voltage	All	V_{IL}	-0.3	—	0.8	V
Device Code with no suffix – Negative Logic (See Ordering Information) (On/OFF pin is open collector/drain logic input with external pull-up resistor; signal referenced to GND)						
Logic High (Module OFF)						
Input High Current	All	I_{IH}	—	—	1	mA
Input High Voltage	All	V_{IH}	3.5	—	$V_{IN,max}$	Vdc
Logic Low (Module ON)						
Input low Current	All	I_{IL}	—	—	10	μA
Input Low Voltage	All	V_{IL}	-0.2	—	0.3	Vdc
Turn-On Delay and Rise Times ($V_{IN}=V_{IN,nom}$, $I_o=I_{o,max}$, V_o to within $\pm 1\%$ of steady state)						
Case 1: On/Off input is enabled and then input power is applied (delay from instant at which $V_{IN} = V_{IN,min}$ until $V_o = 10\%$ of $V_{o,set}$)	All	T_{delay}	—	2	—	msec
Case 2: Input power is applied for at least one second and then the On/Off input is enabled (delay from instant at which On/Off is enabled until $V_o = 10\%$ of $V_{o,set}$)	All	T_{delay}	—	2	—	msec
Output voltage Rise time (time for V_o to rise from 10% of $V_{o,set}$ to 90% of $V_{o,set}$)	All	T_{rise}	—	4	—	msec
Output voltage overshoot ($T_A = 25^\circ\text{C}$ $V_{IN} = V_{IN,min}$ to $V_{IN,max}$, $I_o = I_{o,min}$ to $I_{o,max}$) With or without maximum external capacitance					3	% $V_{o,set}$
Over Temperature Protection (See Thermal Considerations section)	All	T_{ref}		140		$^\circ\text{C}$

16V PicoTLynx™ 4A: Non-Isolated DC-DC Power Modules

8Vdc –16Vdc input; 0.6Vdc to 8.0Vdc output; 4A Output Current

Feature Specifications (cont.)

Parameter	Device	Symbol	Min	Typ	Max	Units
Input Undervoltage Lockout						
Turn-on Threshold	All				4.0	Vdc
Turn-off Threshold	All		3.6			Vdc
Hysteresis	All		0.4			Vdc
PGOOD (Power Good)						
Signal Interface Open Drain, $V_{\text{supply}} \leq 5\text{VDC}$						
Output Voltage Limit for PGOOD	All		90%		110%	$V_{\text{O, set}}$
Pull-down resistance of PGOOD pin	All			7	50	Ω

16V PicoTLynx™ 4A: Non-Isolated DC-DC Power Modules

8Vdc –16Vdc input; 0.6Vdc to 8.0Vdc output; 4A Output Current

Characteristic Curves

The following figures provide typical characteristics for the 16V PicoTLynx™ 4A at 0.6Vo and at 25°C.

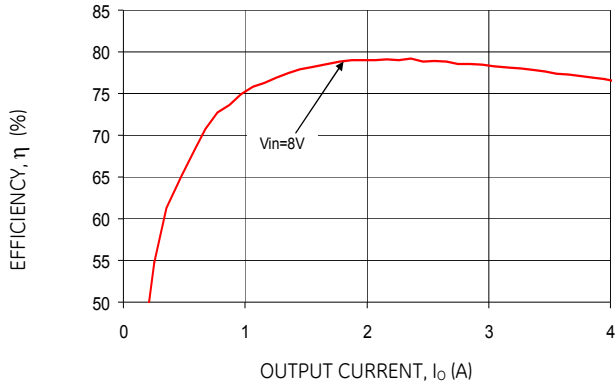

Figure 1. Converter Efficiency versus Output Current.

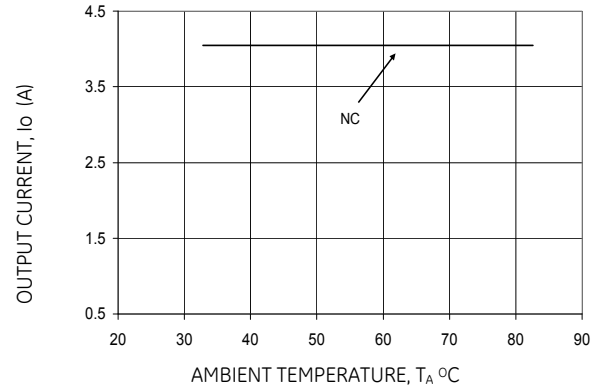

Figure 2. Derating Output Current versus Ambient Temperature and Airflow.

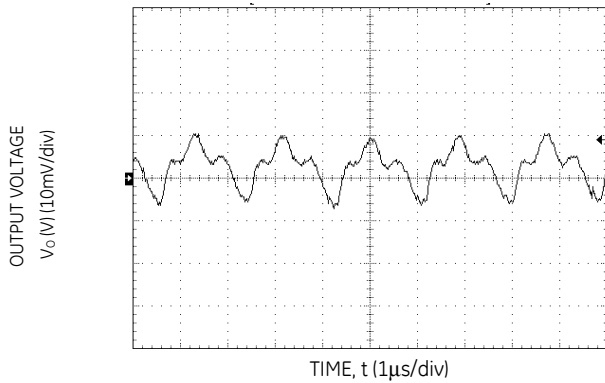

Figure 3. Typical output ripple and noise ($V_{IN} = 8V$, $I_o = I_{o,max}$).

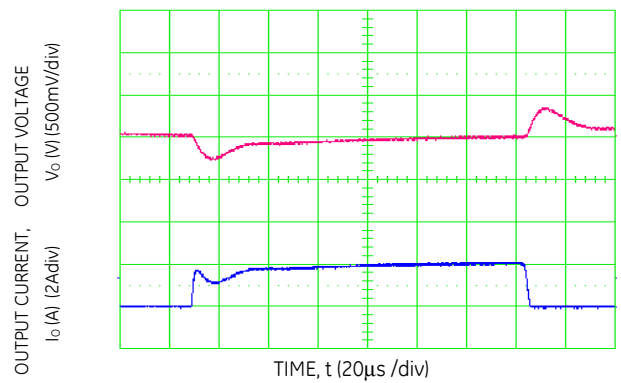

Figure 4. Transient Response to Dynamic Load Change from 0% to 50% to 0% .

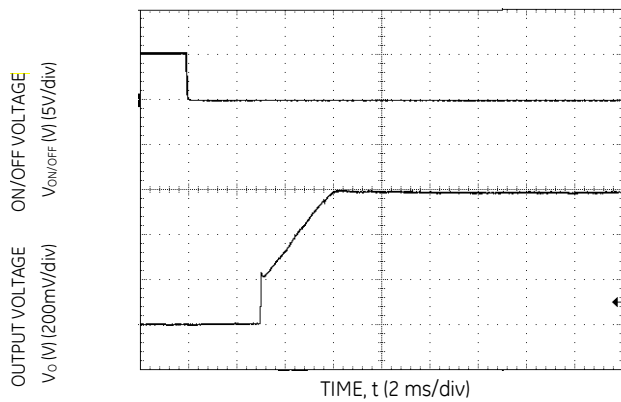

Figure 5. Typical Start-up Using On/Off Voltage ($I_o = I_{o,max}$, $V_{IN} = 8V$)

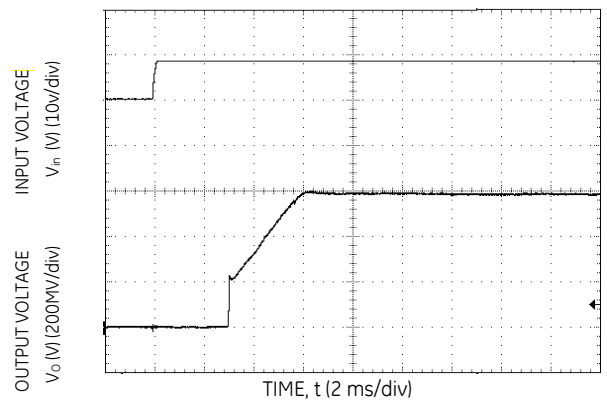

Figure 6. Typical Start-up Using Input Voltage ($V_{IN} = 8V$, $I_o = I_{o,max}$).

16V PicoTLynx™ 4A: Non-Isolated DC-DC Power Modules

8Vdc –16Vdc input; 0.6Vdc to 8.0Vdc output; 4A Output Current

Characteristic Curves

The following figures provide typical characteristics for the 16V PicoTLynx™ 4A at 1.2Vo and at 25°C.

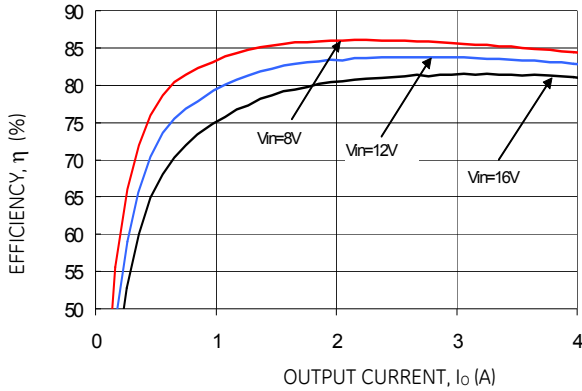

Figure 7. Converter Efficiency versus Output Current.

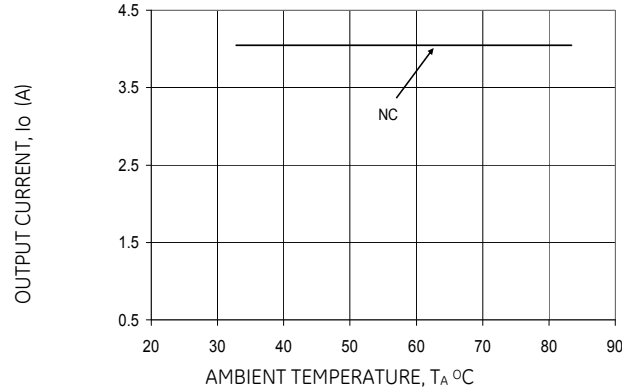

Figure 8. Derating Output Current versus Ambient Temperature and Airflow.

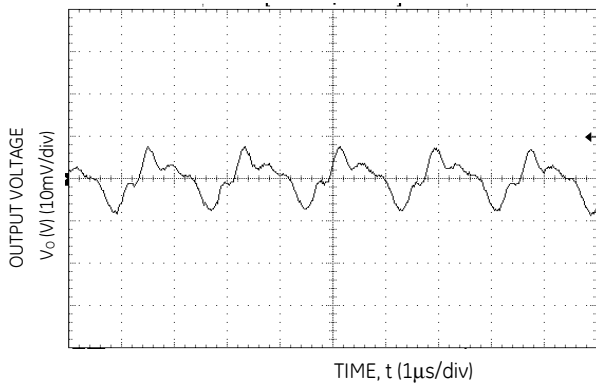

Figure 9. Typical output ripple and noise ($V_{IN} = 12V, I_o = I_{o,max}$).

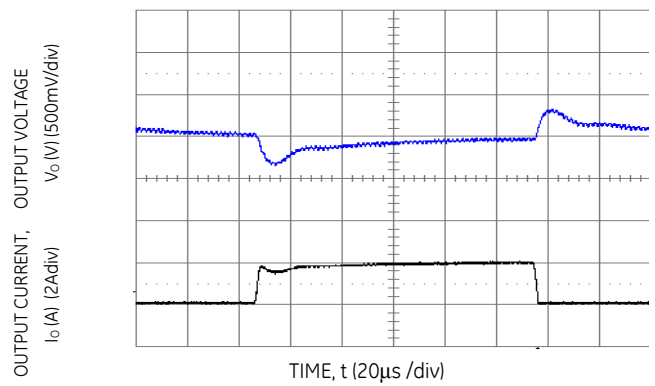

Figure 10. Transient Response to Dynamic Load Change from 0% to 50% to 0%.

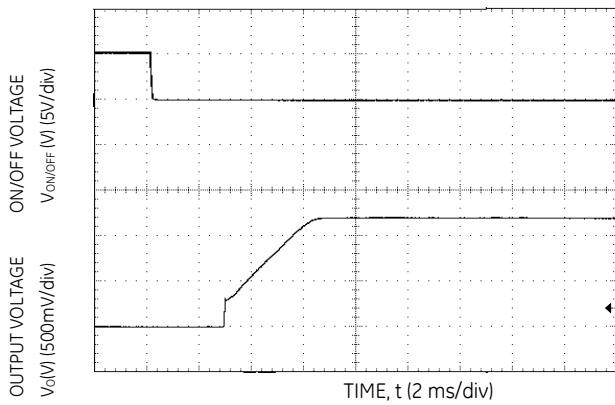

Figure 11. Typical Start-up Using On/Off Voltage ($I_o = I_{o,max}, V_{IN} = 8V$).

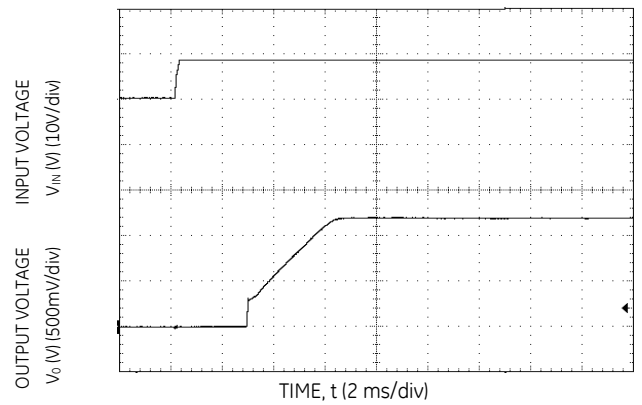

Figure 12. Typical Start-up Using Input Voltage ($V_{IN} = 8V, I_o = I_{o,max}$).

16V PicoTLynx™ 4A: Non-Isolated DC-DC Power Modules

8Vdc – 16Vdc input; 0.6Vdc to 8.0Vdc output; 4A Output Current

Characteristic Curves

The following figures provide typical characteristics for the 16V PicoTLynx™ 4A at 1.8V_o and at 25°C.

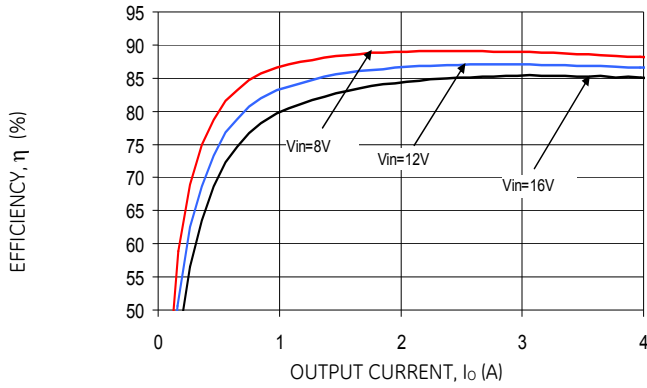

Figure 13. Converter Efficiency versus Output Current.

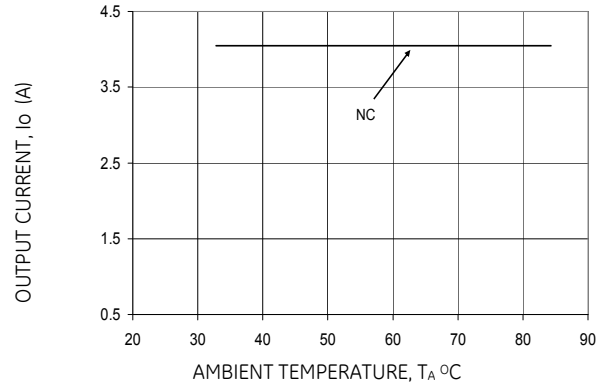

Figure 14. Derating Output Current versus Ambient Temperature and Airflow.

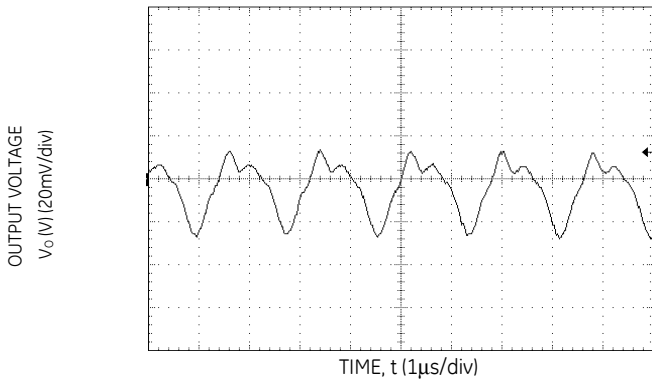

Figure 15. Typical output ripple and noise ($V_{IN} = 12V, I_o = I_{o,max}$).

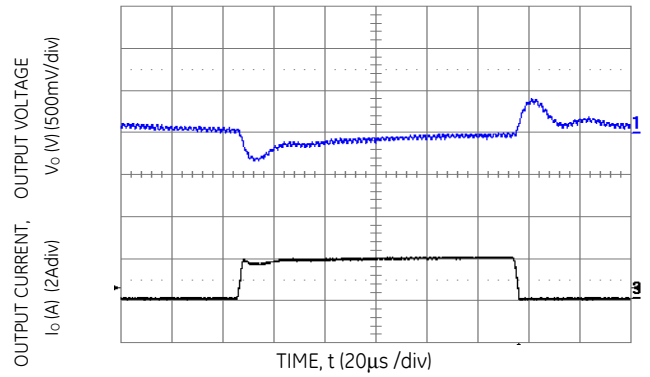

Figure 16. Transient Response to Dynamic Load Change from 0% to 50% to 0%.

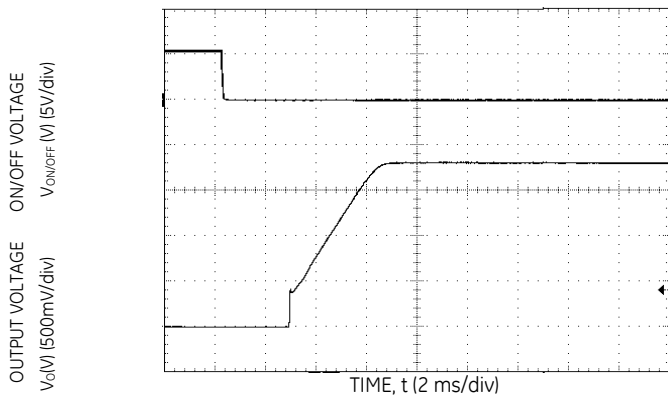

Figure 17. Typical Start-up Using On/Off Voltage ($I_o = I_{o,max}$).

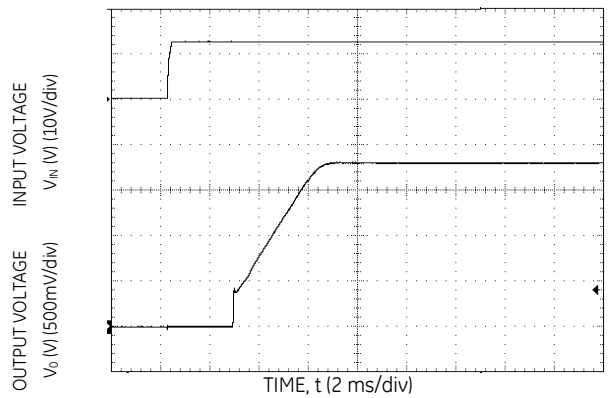

Figure 18. Typical Start-up Using Input Voltage ($V_{IN} = 12V, I_o = I_{o,max}$).

16V PicoTLynx™ 4A: Non-Isolated DC-DC Power Modules

8Vdc – 16Vdc input; 0.6Vdc to 8.0Vdc output; 4A Output Current

Characteristic Curves

The following figures provide typical characteristics for the 16V PicoTLynx™ 4A at 2.5Vo and at 25°C.

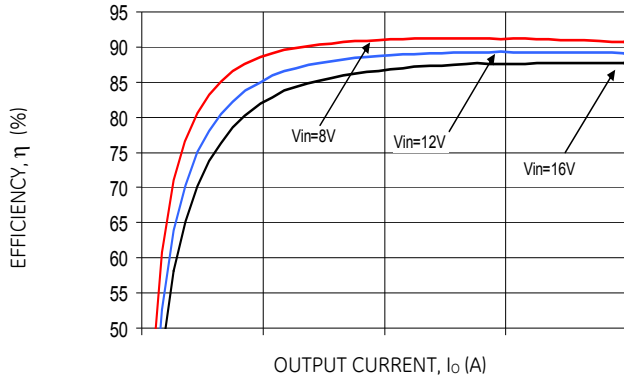

Figure 19. Converter Efficiency versus Output Current.

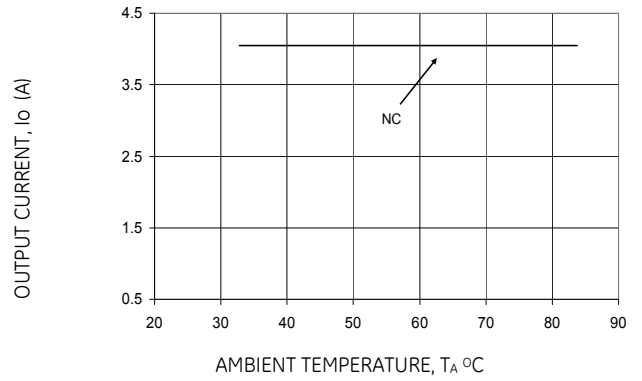

Figure 20. Derating Output Current versus Ambient Temperature and Airflow.

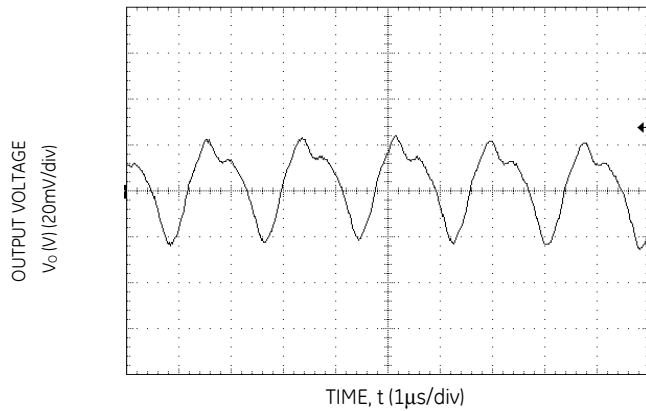

Figure 21. Typical output ripple and noise ($V_{IN} = 12V$, $I_o = I_{o,max}$).

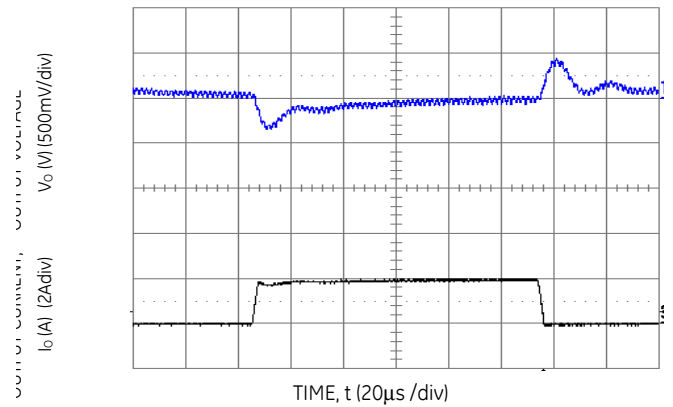

Figure 22. Transient Response to Dynamic Load Change from 0% to 50% to 0%.

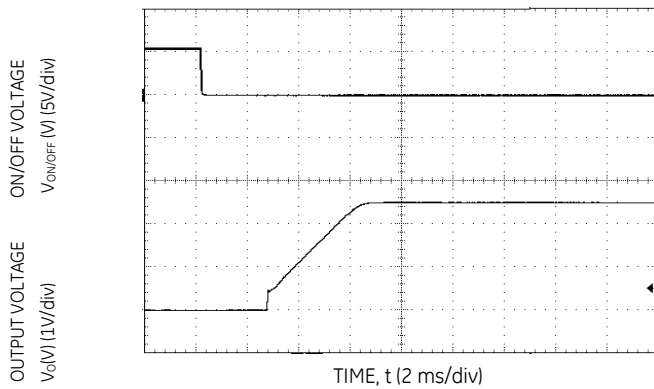

Figure 23. Typical Start-up Using On/Off Voltage ($I_o = I_{o,max}$).

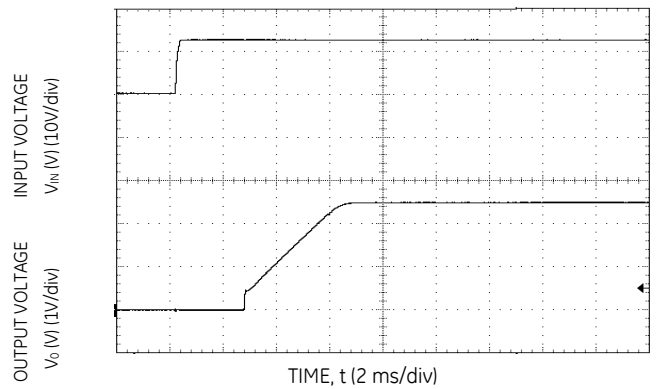

Figure 24. Typical Start-up Using Input Voltage ($V_{IN} = 12V$, $I_o = I_{o,max}$).

16V PicoTLynx™ 4A: Non-Isolated DC-DC Power Modules

8Vdc – 16Vdc input; 0.6Vdc to 8.0Vdc output; 4A Output Current

Characteristic Curves

The following figures provide typical characteristics for the 16V PicoTLynx™ 4A at 3.3V_o and at 25°C.

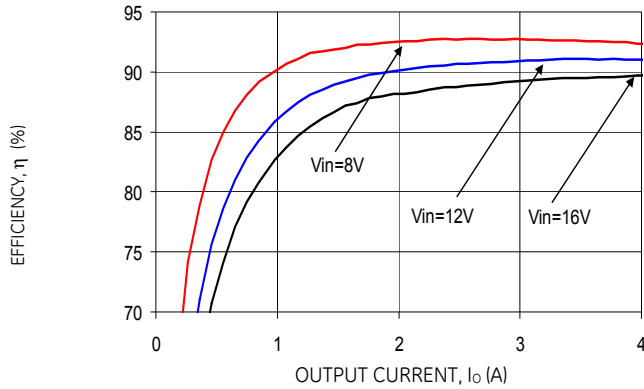

Figure 25. Converter Efficiency versus Output Current.

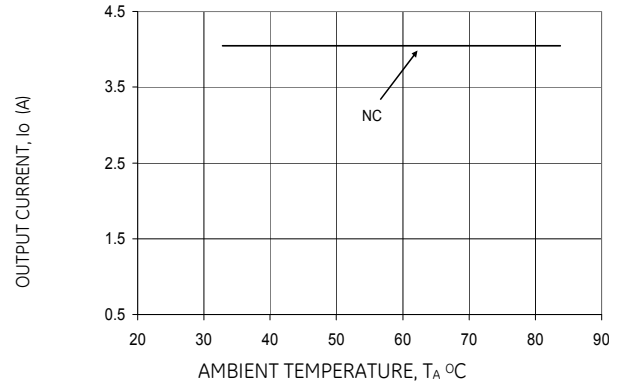

Figure 26. Derating Output Current versus Ambient Temperature and Airflow.

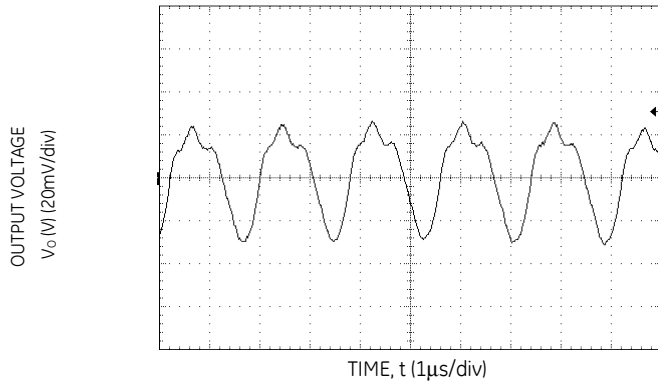

Figure 27. Typical output ripple and noise (VIN = 12V, Io = Io,max).

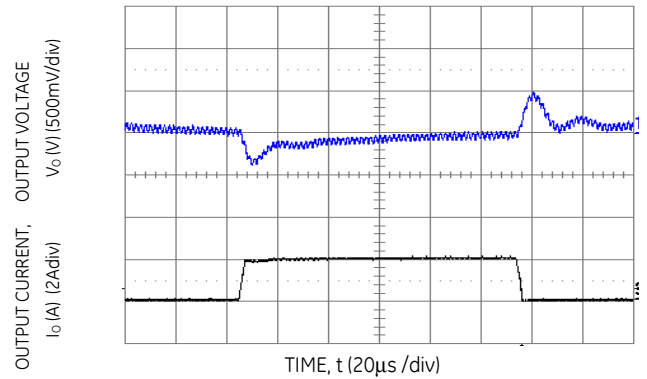

Figure 28. Transient Response to Dynamic Load Change from 0% 50% to 0%.

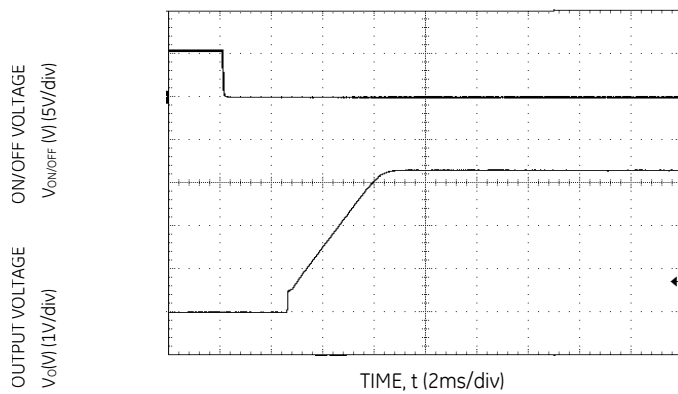

Figure 29. Typical Start-up Using On/Off Voltage (Io = Io,max).

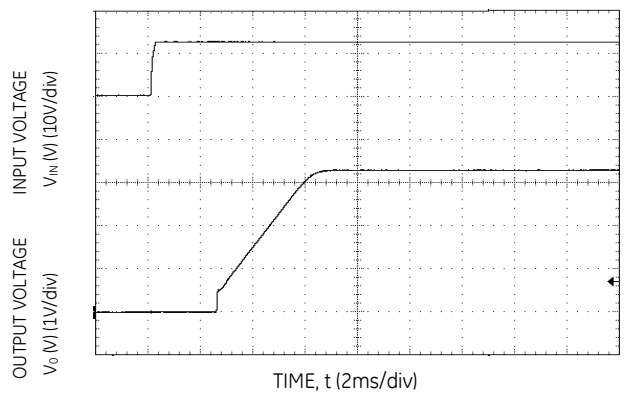

Figure 30. Typical Start-up Using Input Voltage (VIN = 12V, Io = Io,max).

16V PicoTLynx™ 4A: Non-Isolated DC-DC Power Modules

8Vdc –16Vdc input; 0.6Vdc to 8.0Vdc output; 4A Output Current

Characteristic Curves

The following figures provide typical characteristics for the 16V PicoTLynx™ 4A at 5.0 Vo and at 25°C.

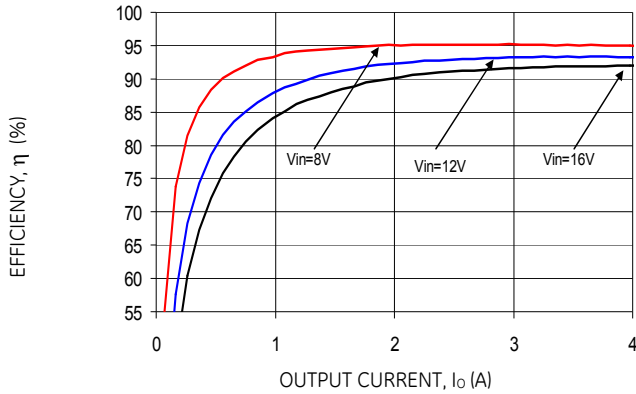

Figure 31. Converter Efficiency versus Output Current.

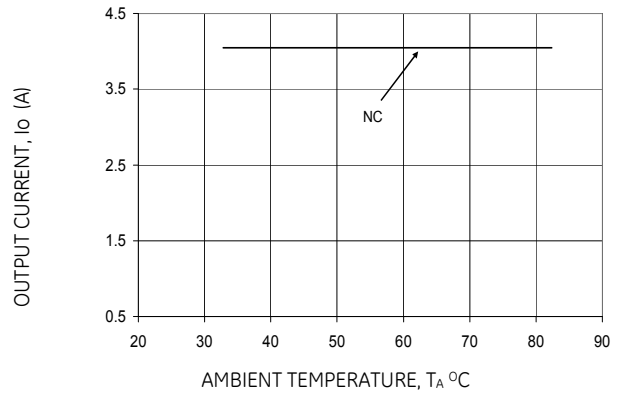

Figure 31. Derating Output Current versus Ambient Temperature and Airflow.

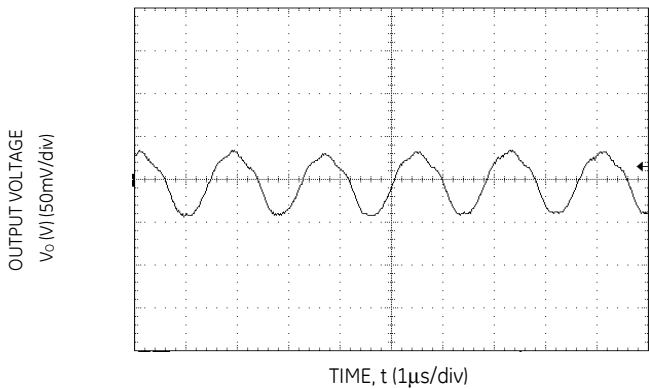

Figure 33. Typical output ripple and noise (VIN = 12V, Io = Io,max).

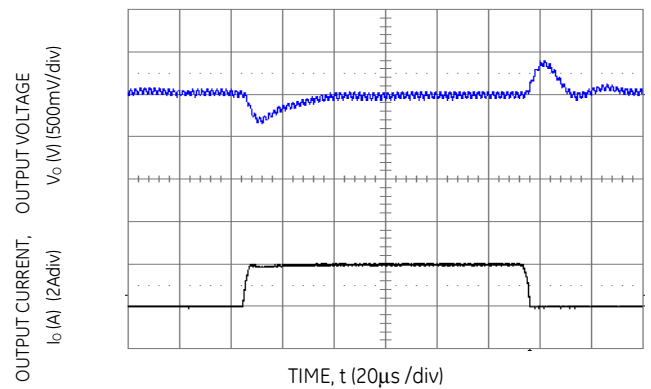

Figure 34. Transient Response to Dynamic Load Change from 0% 50% to 0%.

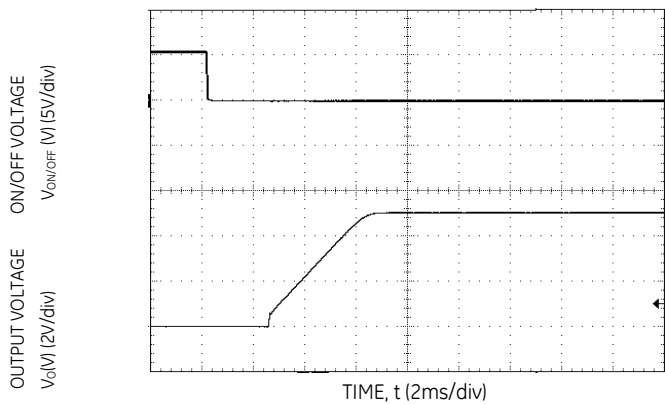

Figure 35. Typical Start-up Using On/Off Voltage (Io = Io,max).

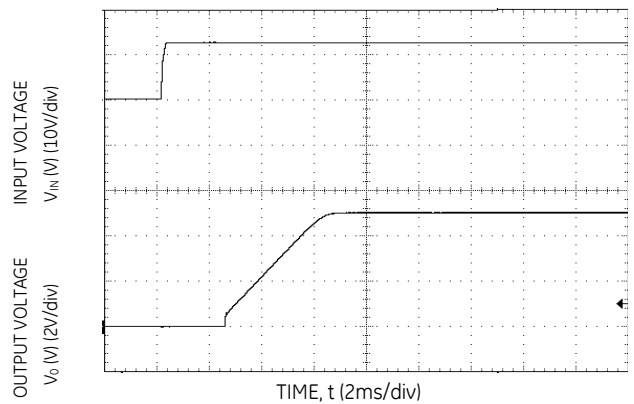

Figure 36. Typical Start-up Using Input Voltage (VIN = 12V, Io = Io,max).

16V PicoTLynx™ 4A: Non-Isolated DC-DC Power Modules

8Vdc –16Vdc input; 0.6Vdc to 8.0Vdc output; 4A Output Current

Characteristic Curves

The following figures provide typical characteristics for the 16V PicoTLynx™ 4A at 6.5 Vo and at 25°C.

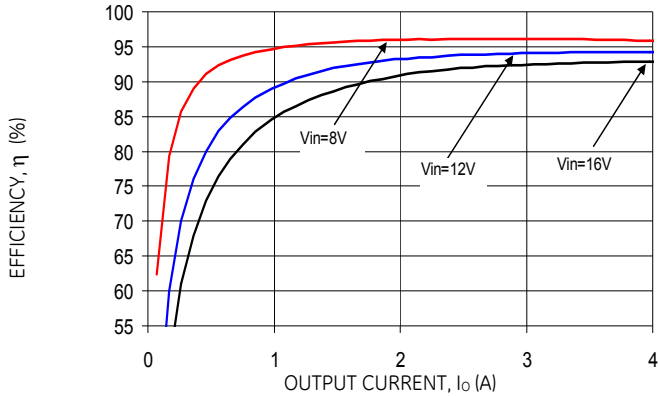

Figure 37. Converter Efficiency versus Output Current.

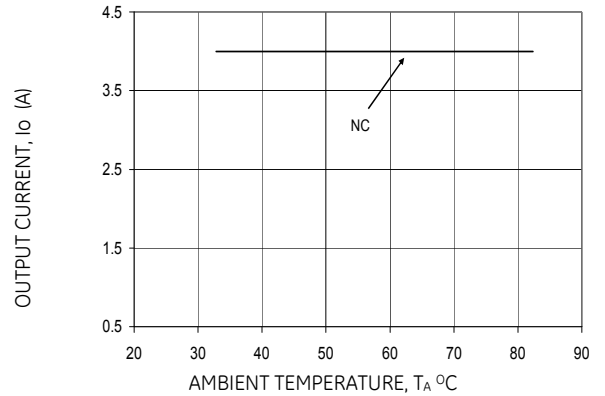

Figure 38. Derating Output Current versus Ambient Temperature and Airflow.

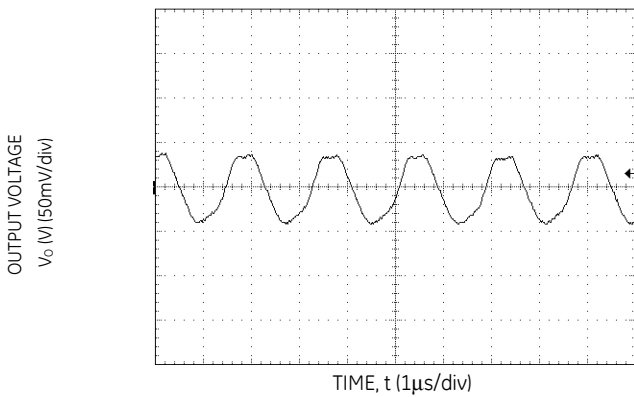

Figure 39. Typical output ripple and noise ($V_{IN} = 12V$, $I_o = I_{o,max}$).

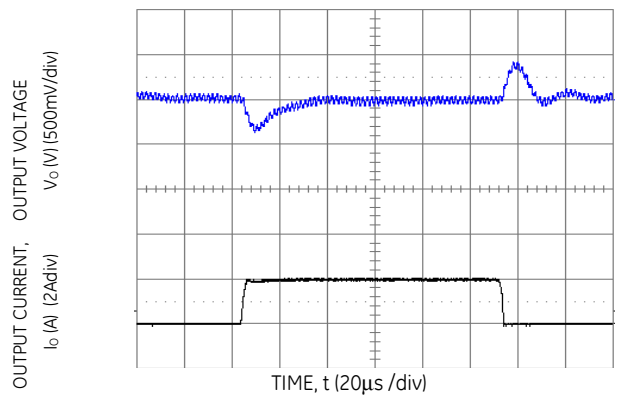

Figure 40. Transient Response to Dynamic Load Change from 0% 50% to 0%.

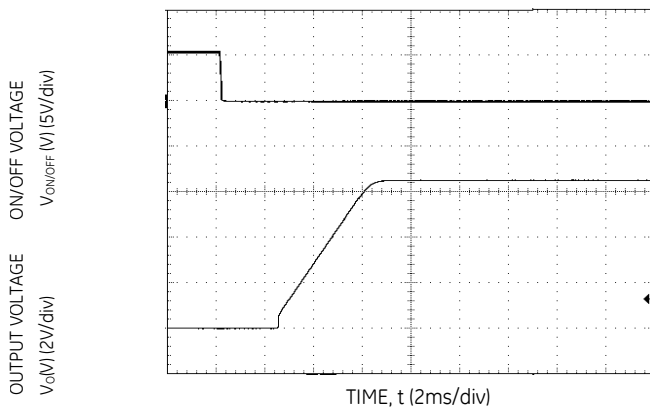

Figure 41. Typical Start-up Using On/Off Voltage ($I_o = I_{o,max}$).

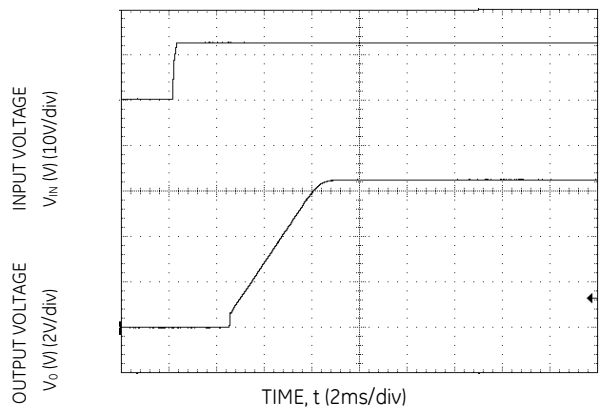

Figure 42. Typical Start-up Using Input Voltage ($V_{IN} = 12V$, $I_o = I_{o,max}$).

16V PicoTLynx™ 4A: Non-Isolated DC-DC Power Modules

8Vdc –16Vdc input; 0.6Vdc to 8.0Vdc output; 4A Output Current

Characteristic Curves

The following figures provide typical characteristics for the 16V PicoTLynx™ 4A at 8.0Vo and at 25°C.

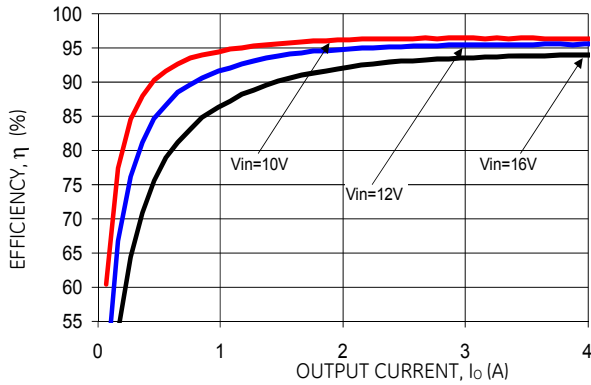

Figure 43. Converter Efficiency versus Output Current.

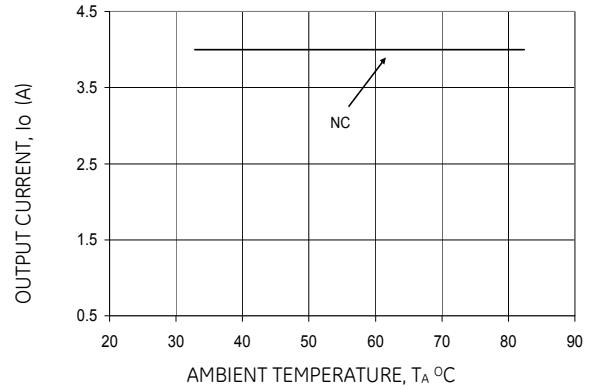

Figure 44. Derating Output Current versus Ambient Temperature and Airflow.

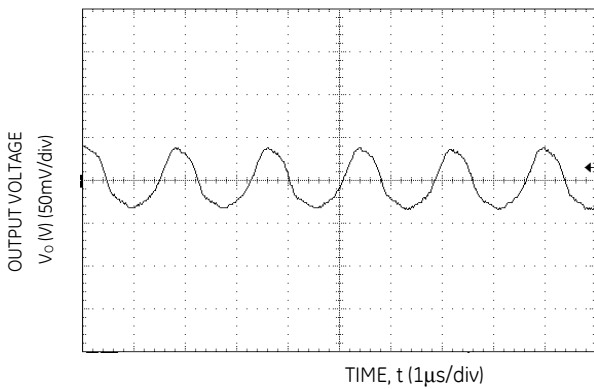

Figure 45. Typical output ripple and noise ($V_{IN} = 12V$, $I_o = I_{o,max}$).

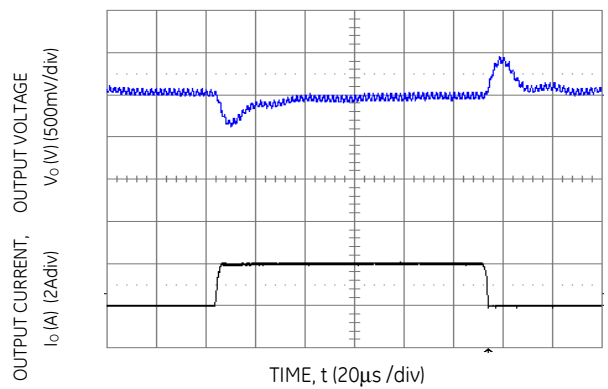

Figure 46. Transient Response to Dynamic Load Change from 0% 50% to 0%.

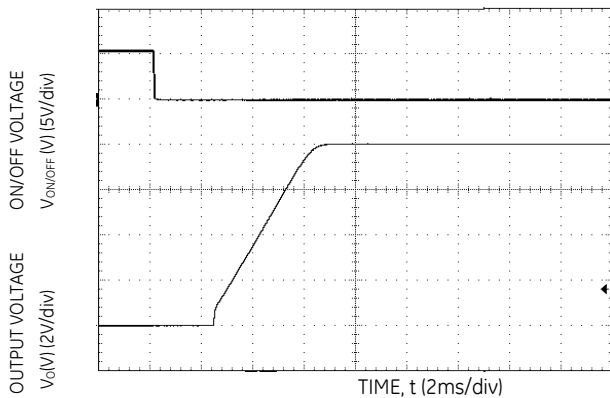

Figure 47. Typical Start-up Using On/Off Voltage ($I_o = I_{o,max}$).

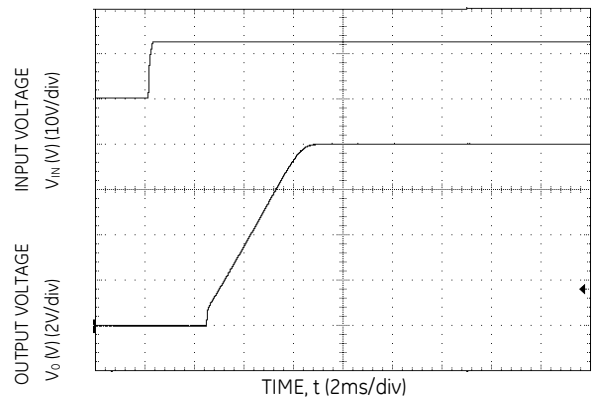
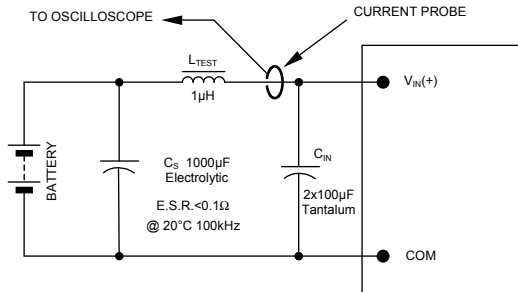

Figure 48. Typical Start-up Using Input Voltage ($V_{IN} = 12V$, $I_o = I_{o,max}$).

16V PicoTlynx™ 4A: Non-Isolated DC-DC Power Modules

8Vdc –16Vdc input; 0.6Vdc to 8.0Vdc output; 4A Output Current

Test Configurations



NOTE: Measure input reflected ripple current with a simulated source inductance (L_{TEST}) of 1µH. Capacitor C_S offsets possible battery impedance. Measure current as shown above.

Figure 49. Input Reflected Ripple Current Test Setup.

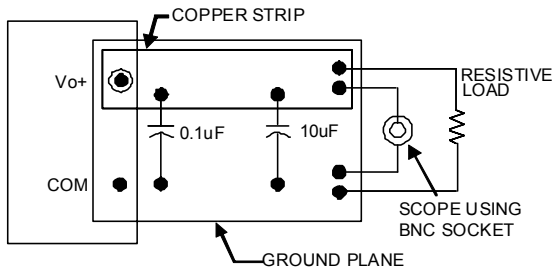

NOTE: All voltage measurements to be taken at the module terminals, as shown above. If sockets are used then Kelvin connections are required at the module terminals to avoid measurement errors due to socket contact resistance.

Figure 50. Output Ripple and Noise Test Setup

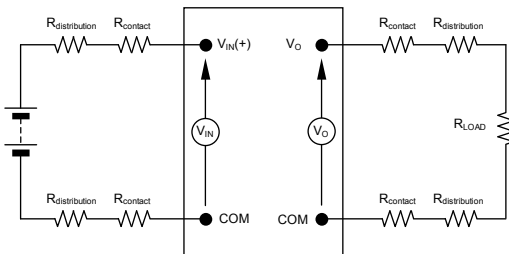

NOTE: All voltage measurements to be taken at the module terminals, as shown above. If sockets are used then Kelvin connections are required at the module terminals to avoid measurement errors due to socket contact resistance.

Figure 51. Output Voltage and Efficiency Test Setup.

$$\text{Efficiency } \eta = \frac{V_O \cdot I_O}{V_{IN} \cdot I_{IN}} \times 100 \%$$

Design Considerations

Input Filtering

The 16V PicoTlynx™ 4A module should be connected to a low ac-impedance source. A highly inductive source can affect the stability of the module. An input capacitance must be placed directly adjacent to the input pin of the module, to minimize input ripple voltage and ensure module stability.

To minimize input voltage ripple, ceramic capacitors are recommended at the input of the module. Figure 52 shows the input ripple voltage for various output voltages at 4A of load current with 1x10 µF or 1x22 µF ceramic capacitors and an input of 12V.

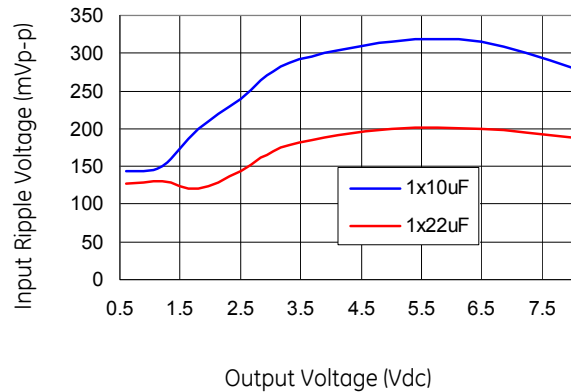

Figure 52. Input ripple voltage for various output voltages with 1x10 µF or 1x22 µF ceramic capacitors at the input (4A load). Input voltage is 12V.

Output Filtering

The 16V PicoTlynx™ 4A modules are designed for low output ripple voltage and will meet the maximum output ripple specification with 0.1 µF ceramic and 10 µF ceramic capacitors at the output of the module. However, additional output filtering may be required by the system designer for a number of reasons. First, there may be a need to further reduce the output ripple and noise of the module. Second, the dynamic response characteristics may need to be customized to a particular load step change.

To reduce the output ripple and improve the dynamic response to a step load change, additional capacitance at the output can be used. Low ESR polymer and ceramic capacitors are recommended to improve the dynamic response of the module. Figure 53 provides output ripple information for different external capacitance values at various V_O and for a load current of 4A. For stable operation of the module, limit the capacitance to less than the maximum output capacitance as specified in the electrical specification table. Optimal performance of the module can be achieved by using the Tunable Loop™ feature described later in this data sheet.

16V PicoTLynx™ 4A: Non-Isolated DC-DC Power Modules

8Vdc –16Vdc input; 0.6Vdc to 8.0Vdc output; 4A Output Current

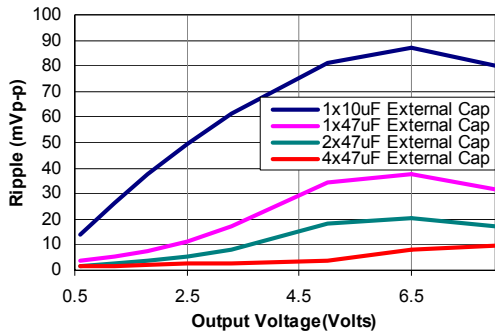

Figure 53. Output ripple voltage for various output voltages with external 1x10 µF, 1x47 µF, 2x47 µF or 4x47 µF ceramic capacitors at the output (4A load). Input voltage is 12V.

Safety Considerations

For safety agency approval the power module must be installed in compliance with the spacing and separation requirements of the end-use safety agency standards, i.e., UL 60950-1, CSA C22.2 No. 60950-1-03, and VDE 0850:2001-12 (EN60950-1) Licensed.

For the converter output to be considered meeting the requirements of safety extra-low voltage (SELV), the input must meet SELV requirements. The power module has extra-low voltage (ELV) outputs when all inputs are ELV.

The input to these units is to be provided with a fast-acting fuse with a maximum rating of 6A in the positive input lead.

Feature Descriptions

Remote Enable

The 16V PicoTLynx™ 4A power modules feature an On/Off pin for remote On/Off operation. Two On/Off logic options are available. In the Positive Logic On/Off option, (device code suffix "4" – see Ordering Information), the module turns ON during a logic High on the On/Off pin and turns OFF during a logic Low. With the Negative Logic On/Off option, (no device code suffix, see Ordering Information), the module turns OFF during logic High and ON during logic Low. The On/Off signal is always referenced to ground. For either On/Off logic option, leaving the On/Off pin disconnected will turn the module ON when input voltage is present.

For positive logic modules, the circuit configuration for using the On/Off pin is shown in Figure 54.

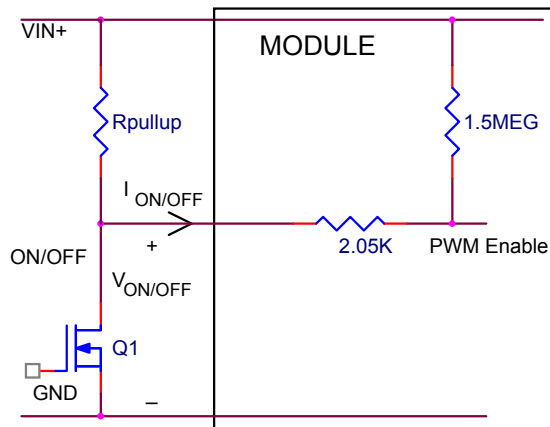

Figure 54. Circuit configuration for using positive On/Off logic.

For negative logic On/Off modules, the circuit configuration is shown in Fig. 55.

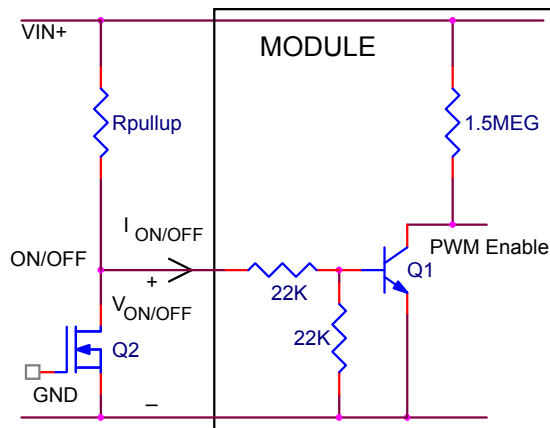

Figure 55. Circuit configuration for using negative On/Off logic.

16V PicoTLynx™ 4A: Non-Isolated DC-DC Power Modules

8Vdc –16Vdc input; 0.6Vdc to 8.0Vdc output; 4A Output Current

Overcurrent Protection

To provide protection in a fault (output overload) condition, the unit is equipped with internal current-limiting circuitry and can endure current limiting continuously. At the point of current-limit inception, the unit enters hiccup mode. The unit operates normally once the output current is brought back into its specified range.

Overtemperature Protection

To provide protection in a fault condition, the unit is equipped with a thermal shutdown circuit. The unit will shutdown if the overtemperature threshold of 140°C is exceeded at the thermal reference point T_{ref} . The thermal shutdown is not intended as a guarantee that the unit will survive temperatures beyond its rating. Once the unit goes into thermal shutdown it will then wait to cool before attempting to restart.

Input Undervoltage Lockout

At input voltages below the input undervoltage lockout limit, the module operation is disabled. The module will begin to operate at an input voltage above the undervoltage lockout turn-on threshold.

Output Voltage Programming

The output voltage of the 16V PicoTLynx™ 4A modules can be programmed to any voltage from 0.59Vdc to 8.0Vdc by connecting a resistor between the Trim and GND pins of the module. Certain restrictions apply on the output voltage set point depending on the input voltage. These are shown in the Output Voltage vs. Input Voltage Set Point Area plot in Fig. 56.

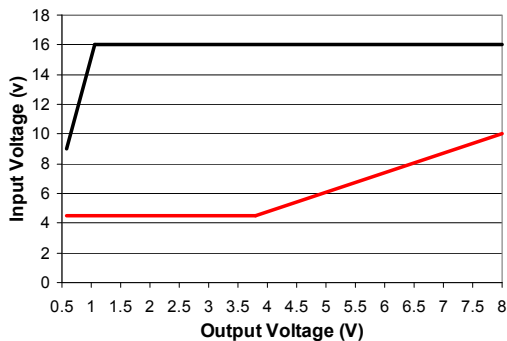

Figure 56. Output Voltage vs. Input Voltage Set Point Area plot showing limits where the output voltage can be set for different input voltages.

Without an external resistor between Trim and GND pins, the output of the module will be 0.59Vdc. To calculate the value of the trim resistor, R_{trim} for a desired output voltage, use the following equation:

$$R_{trim} = \left[\frac{5.91}{(V_o - 0.591)} \right] k\Omega$$

R_{trim} is the external resistor in $k\Omega$

V_o is the desired output voltage.

Table 1 provides R_{trim} values required for some common output voltages.

Table 1

$V_o, set (V)$	$R_{trim} (k\Omega)$
0.6	656.7
1.0	14.45
1.2	9.704
1.5	6.502
1.8	4.888
2.5	3.096
3.3	2.182
5.0	1.340
6.5	1.000
8.0	0.798

By using a $\pm 0.5\%$ tolerance trim resistor with a TC of $\pm 100ppm$, a set point tolerance of $\pm 1.5\%$ can be achieved as specified in the electrical specification.

Remote Sense

The 16V PicoTLynx™ 4A power modules have a Remote Sense feature to minimize the effects of distribution losses by regulating the voltage at the SENSE pin. The voltage between the SENSE pin and VOUT pin must not exceed 0.5V. Note that the output voltage of the module cannot exceed the specified maximum value. This includes the voltage drop between the SENSE and Vout pins. When the Remote Sense feature is not being used, connect the SENSE pin to the VOUT pin.

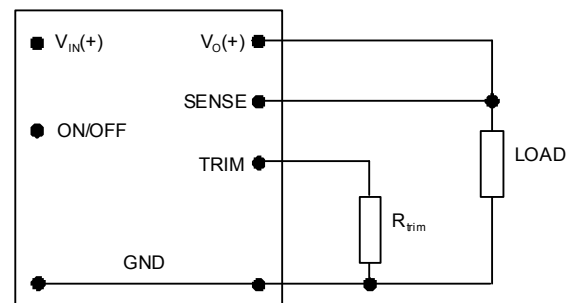

Figure 57. Circuit configuration for programming output voltage using an external resistor.

Voltage Margining

Output voltage margining can be implemented in the 16V PicoTLynx™ 4A modules by connecting a resistor, $R_{margin-up}$, from the Trim pin to the ground pin for margining-up the output voltage and by connecting a resistor, $R_{margin-down}$, from the Trim pin to output pin for margining-down. Figure 10 shows the circuit configuration for output voltage margining. The POL

16V PicoTLynx™ 4A: Non-Isolated DC-DC Power Modules

8Vdc –16Vdc input; 0.6Vdc to 8.0Vdc output; 4A Output Current

Programming Tool, available at www.lineagepower.com under the Design Tools section, also calculates the values of $R_{margin-up}$ and $R_{margin-down}$ for a specific output voltage and % margin. Please consult your local Lineage Power technical representative for additional details.

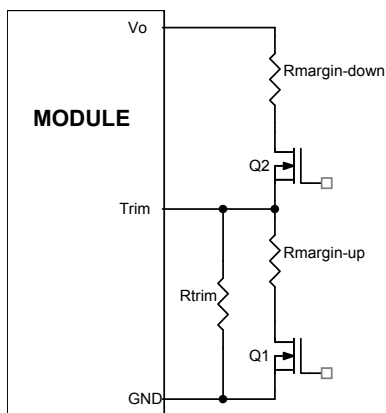

Figure 58. Circuit Configuration for margining Output voltage.

Monotonic Start-up and Shutdown

The 16V PicoTLynx™ 4A modules have monotonic start-up and shutdown behavior for any combination of rated input voltage, output current and operating temperature range.

Startup into Pre-biased Output

The 16V PicoTLynx™ 4A modules can start into a prebiased output as long as the prebias voltage is 0.5V less than the set output voltage. Note that prebias operation is not supported when output voltage sequencing is used.

Power Good

The 16V PicoTLynx™ 4A modules provide a Power Good (PGOOD) signal that is implemented with an open-drain output to indicate that the output voltage is within the regulation limits of the power module. The PGOOD signal will be de-asserted to a low state if any condition such as overtemperature, overcurrent or loss of regulation occurs that would result in the output voltage going $\pm 10\%$ outside the setpoint value. The PGOOD terminal should be connected through a pullup resistor (suggested value 100K Ω) to a source of 5VDC or lower.

Tunable Loop™

The 16V PicoTLynx™ 4A modules have a new feature that optimizes transient response of the module called Tunable Loop™.

External capacitors are usually added to the output of the module for two reasons: to reduce output ripple and noise (see Fig. 53) and to reduce output voltage deviations from the steady-state value in the presence of dynamic load current

changes. Adding external capacitance however affects the voltage control loop of the module, typically causing the loop to slow down with sluggish response. Larger values of external capacitance could also cause the module to become unstable.

The Tunable Loop™ allows the user to externally adjust the voltage control loop to match the filter network connected to the output of the module. The Tunable Loop™ is implemented by connecting a series R-C between the SENSE and TRIM pins of the module, as shown in Fig. 59. This R-C allows the user to externally adjust the voltage loop feedback compensation of the module.

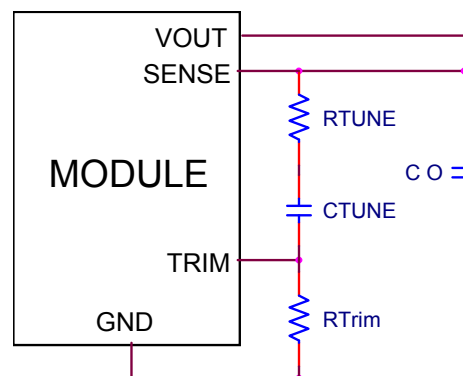

Figure 59. Circuit diagram showing connection of R_{TUNE} and C_{TUNE} to tune the control loop of the module.

Recommended values of R_{TUNE} and C_{TUNE} for different output capacitor combinations are given in Tables 2 and 3. Table 2 shows the recommended values of R_{TUNE} and C_{TUNE} for different values of ceramic output capacitors up to 470 μF that might be needed for an application to meet output ripple and noise requirements. Selecting R_{TUNE} and C_{TUNE} according to Table 2 will ensure stable operation of the module.

In applications with tight output voltage limits in the presence of dynamic current loading, additional output capacitance will be required. Table 3 lists recommended values of R_{TUNE} and C_{TUNE} in order to meet 2% output voltage deviation limits for some common output voltages in the presence of a 2A to 4A step change (50% of full load), with an input voltage of 16V.

Please contact your Lineage Power technical representative to obtain more details of this feature as well as for guidelines on how to select the right value of external R-C to tune the module for best transient performance and stable operation for other output capacitance values or input voltages other than 16V.

Table 2. General recommended values of R_{TUNE} and C_{TUNE} for $V_{in}=12\text{V}$ and various external ceramic capacitor combinations.

$V_o=6.5$

16V PicoTLynx™ 4A: Non-Isolated DC-DC Power Modules

8Vdc –16Vdc input; 0.6Vdc to 8.0Vdc output; 4A Output Current

Co	1x47μF	2x47μF	4x47μF	6x47μF	10x47μF
R _{TUNE}	150	150	100	75	75
C _{TUNE}	2700pF	5600pF	10nF	12nF	18nF

V_o=1.8

Co	1x47μF	2x47μF	4x47μF	6x47μF	10x47μF
R _{TUNE}	100	75	75	75	75
C _{TUNE}	6800pF	12nF	18nF	18nF	18nF

Table 3. Recommended values of R_{TUNE} and C_{TUNE} to obtain transient deviation of ≤2% of V_{out} for a 2A step load with V_{in}=16V.

V _o	8V	6.5V	5V	3.3V	2.5V	1.8V
Co	1x47μF	2x47μF	2x47μF	2x47μF	3x47μF	4x47μF
R _{TUNE}	150	150	100	100	75	75
C _{TUNE}	2700pF	5600pF	6900pF	8200pF	12nF	18nF
ΔV	160mV	87mV	69mV	61mV	43mV	33mV

V _o	1.2V	0.6V
Co	1 x 330μF Polymer	1x47μF + 2 x330μF Polymer
R _{TUNE}	75	75
C _{TUNE}	56nF	100nF
ΔV	21mV	11.4mV

16V PicoTLynx™ 4A: Non-Isolated DC-DC Power Modules

8Vdc –16Vdc input; 0.6Vdc to 8.0Vdc output; 4A Output Current

Thermal Considerations

Power modules operate in a variety of thermal environments; however, sufficient cooling should always be provided to help ensure reliable operation.

Considerations include ambient temperature, airflow, module power dissipation, and the need for increased reliability. A reduction in the operating temperature of the module will result in an increase in reliability. The thermal data presented here is based on physical measurements taken in a wind tunnel. The test set-up is shown in Figure 60. The preferred airflow direction for the module is in Figure 61.

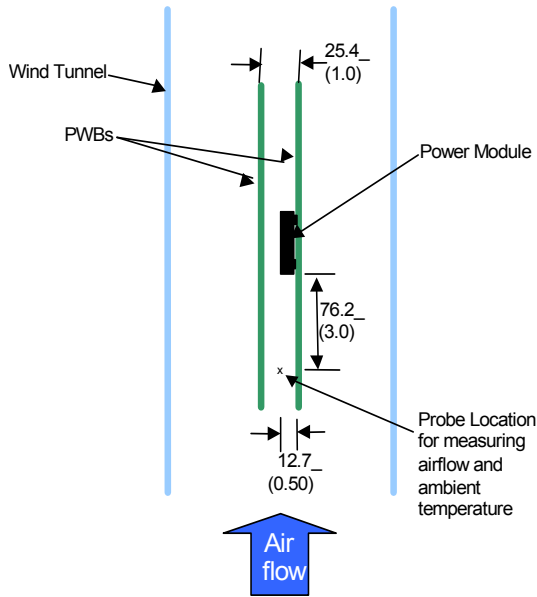

Figure 60. Thermal Test Setup.

The thermal reference points, T_{ref} used in the specifications are also shown in Figure 60. For reliable operation the temperatures at these points should not exceed 120°C. The output power of the module should not exceed the rated power of the module ($V_{o,set} \times I_{o,max}$).

Please refer to the Application Note “Thermal Characterization Process For Open-Frame Board-Mounted Power Modules” for a detailed discussion of thermal aspects including maximum device temperatures.

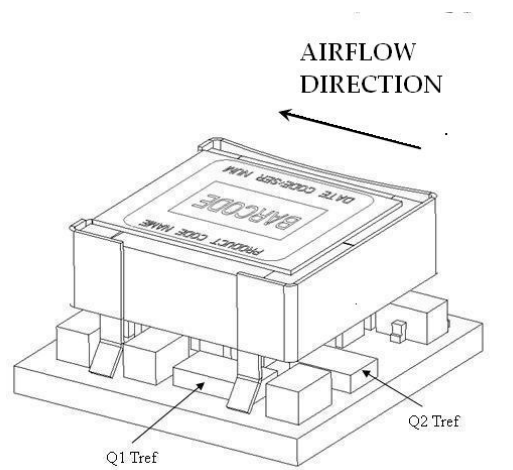

Figure 61. Preferred airflow direction and location of hot-spot of the module (Tref).

16V PicoTLynx™ 4A: Non-Isolated DC-DC Power Modules

8Vdc –16Vdc input; 0.6Vdc to 8.0Vdc output; 4A Output Current

Shock and Vibration

The ruggedized (-D version) of the modules are designed to withstand elevated levels of shock and vibration to be able to operate in harsh environments. The ruggedized modules have been successfully tested to the following conditions:

Non operating random vibration:

Random vibration tests conducted at 25C, 10 to 2000Hz, for 30 minutes each level, starting from 30Grms (Z axis) and up to 50Grms (X axis). The units were then subjected to two more tests of 50Grms at 30 minutes each for a total of 90 minutes.

Operating shock to 40G per Mil Std. 810F, Method 516.4 Procedure I:

The modules were tested in opposing directions along each of three orthogonal axes, with waveform and amplitude of the shock impulse characteristics as follows:

All shocks were half sine pulses, 11 milliseconds (ms) in duration in all 3 axes.

Units were tested to the Functional Shock Test of MIL-STD-810, Method 516.4, Procedure I - Figure 516.4-4. A shock magnitude of 40G was utilized. The operational units were subjected to three shocks in each direction along three axes for a total of eighteen shocks.

Operating vibration per Mil Std 810F, Method 514.5 Procedure I:

The ruggedized (-D version) modules are designed and tested to vibration levels as outlined in MIL-STD-810F, Method 514.5, and Procedure 1, using the Power Spectral Density (PSD) profiles as shown in Table 4 and Table 5 for all axes. Full compliance with performance specifications was required during the performance test. No damage was allowed to the module and full compliance to performance specifications was required when the endurance environment was removed. The module was tested per MIL-STD-810, Method 514.5, Procedure I, for functional (performance) and endurance random vibration using the performance and endurance levels shown in Table 4 and Table 5 for all axes. The performance test has been split, with one half accomplished before the endurance test and one half after the endurance test (in each axis). The duration of the performance test was at least 16 minutes total per axis and at least 120 minutes total per axis for the endurance test. The endurance test period was 2 hours minimum per axis.

Table 4: Performance Vibration Qualification - All Axes

Frequency (Hz)	PSD Level (G ² /Hz)	Frequency (Hz)	PSD Level (G ² /Hz)	Frequency (Hz)	PSD Level (G ² /Hz)
10	1.14E-03	170	2.54E-03	690	1.03E-03
30	5.96E-03	230	3.70E-03	800	7.29E-03
40	9.53E-04	290	7.99E-04	890	1.00E-03
50	2.08E-03	340	1.12E-02	1070	2.67E-03
90	2.08E-03	370	1.12E-02	1240	1.08E-03
110	7.05E-04	430	8.84E-04	1550	2.54E-03
130	5.00E-03	490	1.54E-03	1780	2.88E-03
140	8.20E-04	560	5.62E-04	2000	5.62E-04

Table 5: Endurance Vibration Qualification - All Axes

Frequency (Hz)	PSD Level (G ² /Hz)	Frequency (Hz)	PSD Level (G ² /Hz)	Frequency (Hz)	PSD Level (G ² /Hz)
10	0.00803	170	0.01795	690	0.00727
30	0.04216	230	0.02616	800	0.05155
40	0.00674	290	0.00565	890	0.00709
50	0.01468	340	0.07901	1070	0.01887
90	0.01468	370	0.07901	1240	0.00764
110	0.00498	430	0.00625	1550	0.01795
130	0.03536	490	0.01086	1780	0.02035
140	0.0058	560	0.00398	2000	0.00398

16V PicoTLynx™ 4A: Non-Isolated DC-DC Power Modules

8Vdc –16Vdc input; 0.6Vdc to 8.0Vdc output; 4A Output Current

Example Application Circuit

Requirements:

Vin:	16V
Vout:	1.8V
Iout:	3A max., worst case load transient is from 2A to 3A
ΔV_{out} :	1.5% of Vout (27mV) for worst case load transient
Vin, ripple	1.5% of Vin (240mV, p-p)

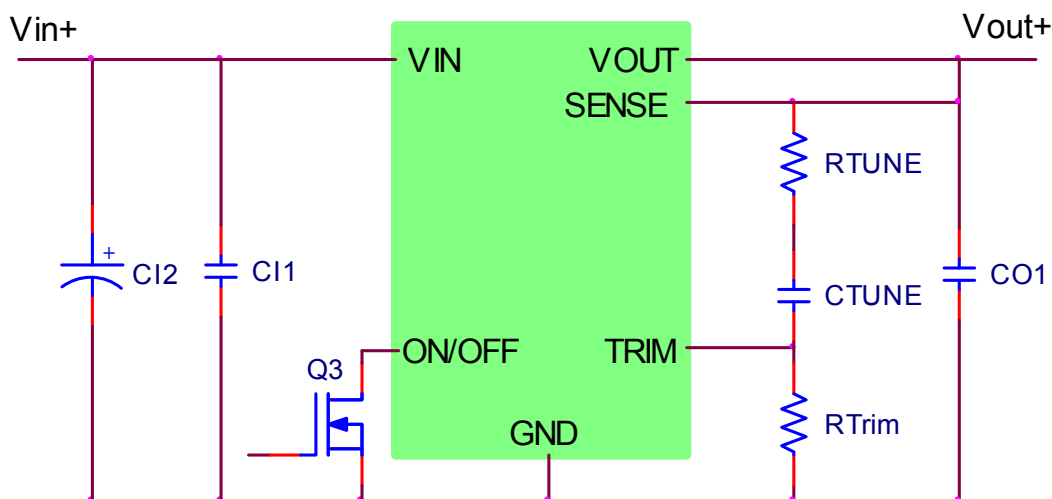

C11	10 μ F/25V ceramic capacitor (e.g. Murata GRM31CR61E106KA12)
C12	100 μ F/25V bulk electrolytic
CO1	4 x 47 μ F/10V ceramic capacitor (e.g. Murata GRM32ER61A476KE20)
CTune	18nF/50V ceramic capacitor (can be 1206, 0805 or 0603 size)
RTune	75 ohms SMT resistor (can be 1206, 0805 or 0603 size)
RTrim	4.87k Ω SMT resistor (can be 1206, 0805 or 0603 size, recommended tolerance of 0.1%)

16V PicoTLynx™ 4A: Non-Isolated DC-DC Power Modules

8Vdc –16Vdc input; 0.6Vdc to 8.0Vdc output; 4A Output Current

Mechanical Outline

Dimensions are in millimeters and (inches).

Tolerances: x.x mm ± 0.5 mm (x.xx in. ± 0.02 in.) [unless otherwise indicated]

x.xx mm ± 0.25 mm (x.xxx in ± 0.010 in.)

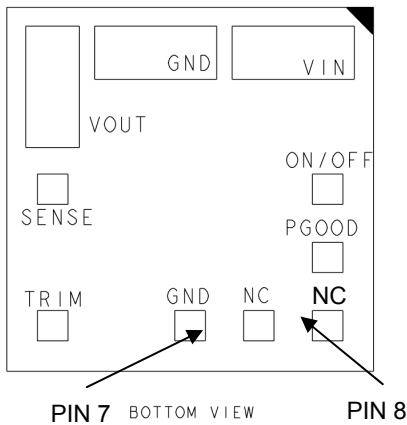
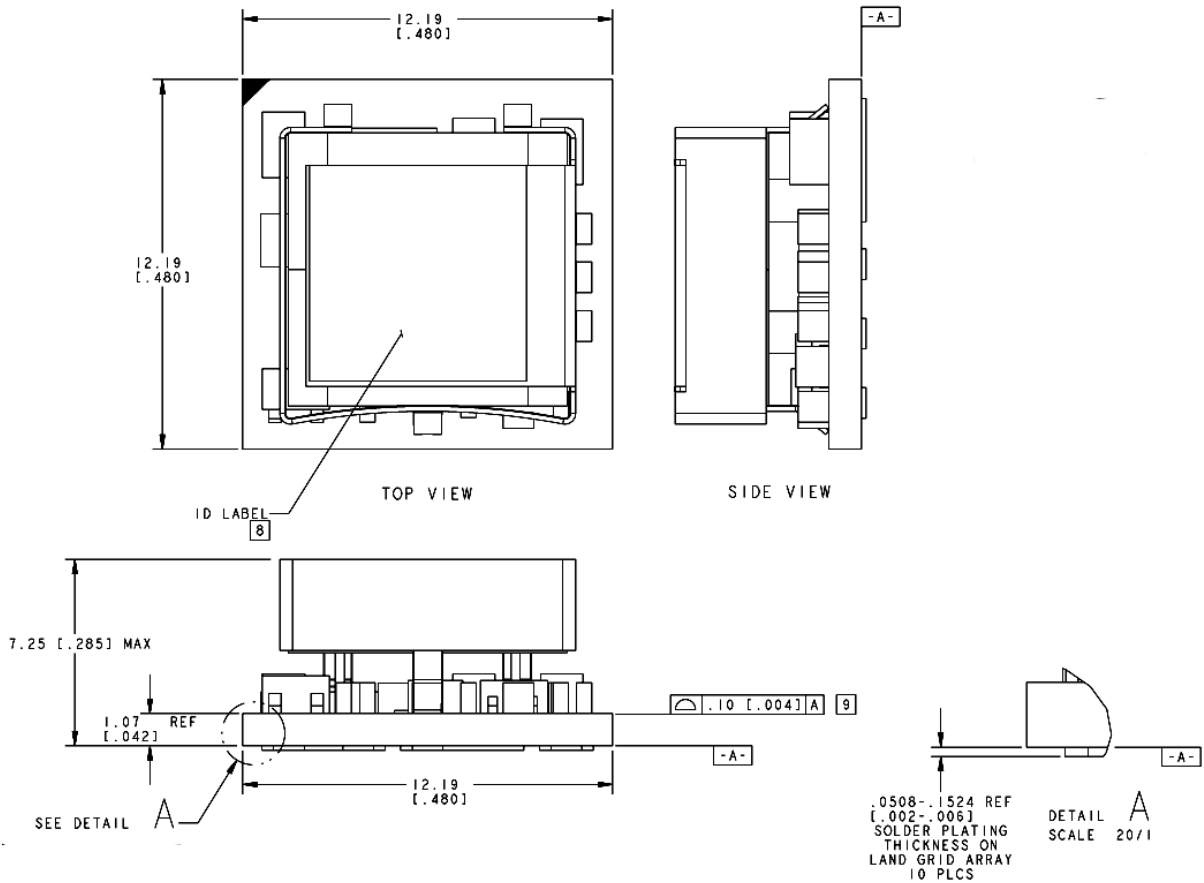

PIN	FUNCTION
1	ON/OFF
2	VIN
3	GND
4	VOUT
5	SENSE
6	TRIM
7	GND
8	NC
9	NC
10	PGOOD

16V PicoTLynx™ 4A: Non-Isolated DC-DC Power Modules

8Vdc –16Vdc input; 0.6Vdc to 8.0Vdc output; 4A Output Current

Recommended Pad Layout

Dimensions are in millimeters and (inches)

Tolerances: x.x mm ± 0.5 mm (x.xx in. ± 0.02 in.) [unless otherwise indicated]

x.xx mm ± 0.25 mm (x.xxx in ± 0.010 in.)

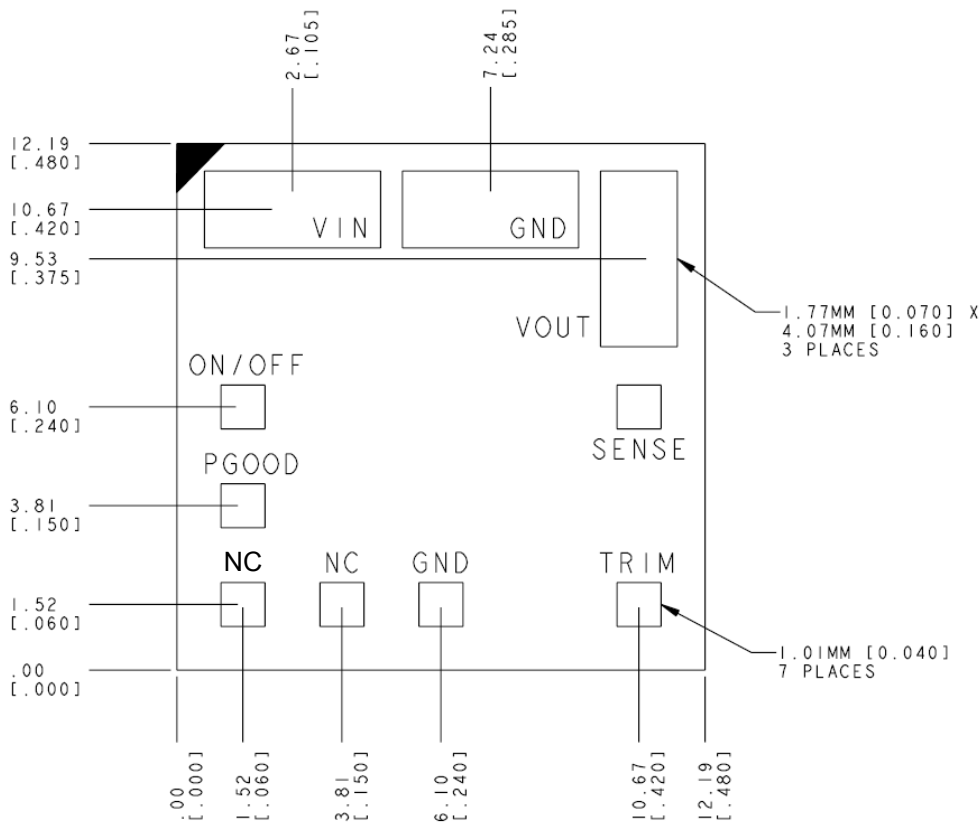

RECOMMENDED FOOTPRINT
- THROUGH THE BOARD -

PIN	FUNCTION
1	ON/OFF
2	VIN
3	GND
4	VOUT
5	SENSE
6	TRIM
7	GND
8	NC
9	NC
10	PGOOD

16V PicoTLynx™ 4A: Non-Isolated DC-DC Power Modules

8Vdc –16Vdc input; 0.6Vdc to 8.0Vdc output; 4A Output Current

Packaging Details

The 16V PicoTLynx™ 4A modules are supplied in tape & reel as standard. Modules are shipped in quantities of 400 modules per reel. All Dimensions are in millimeters and (in inches).

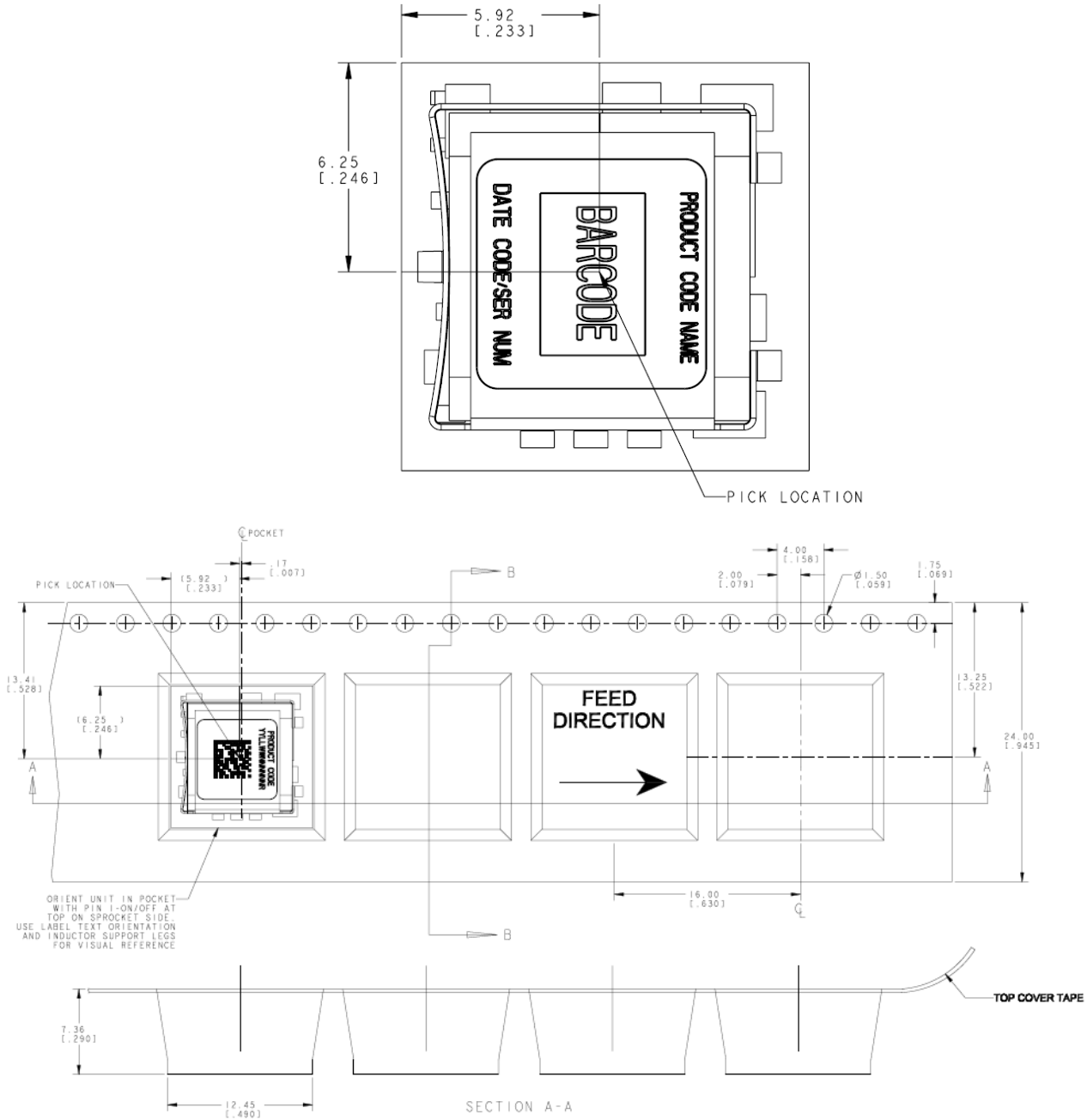

Reel Dimensions:

Outside Dimensions: 330.2 mm (13.00)

Inside Dimensions: 177.8 mm (7.00")

Tape Width: 24.00 mm (0.945")

16V PicoTLynx™ 4A: Non-Isolated DC-DC Power Modules

8Vdc –16Vdc input; 0.6Vdc to 8.0Vdc output; 4A Output Current

Surface Mount Information

Pick and Place

The 16V PicoTLynx™ 4A modules use an open frame construction and are designed for a fully automated assembly process. The modules are fitted with a label designed to provide a large surface area for pick and place operations. The label meets all the requirements for surface mount processing, as well as safety standards, and is able to withstand reflow temperatures of up to 300°C. The label also carries product information such as product code, serial number and the location of manufacture.

Nozzle Recommendations

The module weight has been kept to a minimum by using open frame construction. Variables such as nozzle size, tip style, vacuum pressure and placement speed should be considered to optimize this process. The minimum recommended inside nozzle diameter for reliable operation is 3mm. The maximum nozzle outer diameter, which will safely fit within the allowable component spacing, is 7 mm.

Bottom Side / First Side Assembly

This module is not recommended for assembly on the bottom side of a customer board. If such an assembly is attempted, components may fall off the module during the second reflow process. If assembly on the bottom side is planned, please contact Lineage Power for special manufacturing process instructions.

Only ruggedized (-D version) modules with additional epoxy will work with a customer's first side assembly. For other versions, first side assembly should be avoided.

Lead Free Soldering

The 16V PicoTLynx™ 4A modules are lead-free (Pb-free) and RoHS compliant and fully compatible in a Pb-free soldering process. Failure to observe the instructions below may result in the failure of or cause damage to the modules and can adversely affect long-term reliability.

Pb-free Reflow Profile

Power Systems will comply with J-STD-020 Rev. C (Moisture/Reflow Sensitivity Classification for Nonhermetic Solid State Surface Mount Devices) for both Pb-free solder profiles and MSL classification procedures. This standard provides a recommended forced-air-convection reflow profile based on the volume and thickness of the package (table 4-2). The suggested Pb-free solder paste is Sn/Ag/Cu (SAC). The recommended linear reflow profile using Sn/Ag/Cu solder is

shown in Fig. 62. Soldering outside of the recommended profile requires testing to verify results and performance. For questions regarding Land grid array(LGA) soldering, solder volume; please contact Lineage Power for special manufacturing process instructions

MSL Rating

The 16V PicoTLynx™ 4A modules have a MSL rating of 2a.

Storage and Handling

The recommended storage environment and handling procedures for moisture-sensitive surface mount packages is detailed in J-STD-033 Rev. A (Handling, Packing, Shipping and Use of Moisture/Reflow Sensitive Surface Mount Devices). Moisture barrier bags (MBB) with desiccant are required for MSL ratings of 2 or greater. These sealed packages should not be broken until time of use. Once the original package is broken, the floor life of the product at conditions of $\leq 30^{\circ}\text{C}$ and 60% relative humidity varies according to the MSL rating (see J-STD-033A). The shelf life for dry packed SMT packages will be a minimum of 12 months from the bag seal date, when stored at the following conditions: $< 40^{\circ}\text{C}$, $< 90\%$ relative humidity.

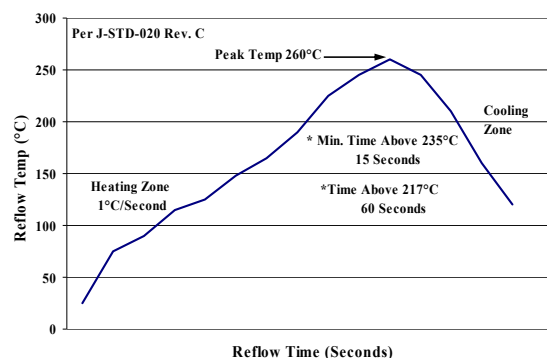

Figure

62. Recommended linear reflow profile using Sn/Ag/Cu solder.

Post Solder Cleaning and Drying Considerations

Post solder cleaning is usually the final circuit-board assembly process prior to electrical board testing. The result of inadequate cleaning and drying can affect both the reliability of a power module and the testability of the finished circuit-board assembly. For guidance on appropriate soldering, cleaning and drying procedures, refer to *Board Mounted Power Modules: Soldering and Cleaning Application Note (AN04-001)*.