



Chipsmall Limited consists of a professional team with an average of over 10 year of expertise in the distribution of electronic components. Based in Hongkong, we have already established firm and mutual-benefit business relationships with customers from,Europe,America and south Asia,supplying obsolete and hard-to-find components to meet their specific needs.

With the principle of “Quality Parts,Customers Priority,Honest Operation,and Considerate Service”,our business mainly focus on the distribution of electronic components. Line cards we deal with include Microchip,ALPS,ROHM,Xilinx,Pulse,ON,Everlight and Freescale. Main products comprise IC,Modules,Potentiometer,IC Socket,Relay,Connector.Our parts cover such applications as commercial,industrial, and automotives areas.

We are looking forward to setting up business relationship with you and hope to provide you with the best service and solution. Let us make a better world for our industry!



Contact us

Tel: +86-755-8981 8866 Fax: +86-755-8427 6832

Email & Skype: info@chipsmall.com Web: www.chipsmall.com

Address: A1208, Overseas Decoration Building, #122 Zhenhua RD., Futian, Shenzhen, China





Features

- Carbon element
- Assortment of resistance tapers
- Push latching shaft
- Flatted, knurled and slotted shaft styles
- Center detent option



PTP90 Series Panel Control w/Push Latching Shaft

Electrical Characteristics

Standard Resistance Range 1K ohms to 1 megohm
 Standard Resistance Tolerance
 R < 250K ohms ±20 %
 R ≥ 250K ohms ±30 %
 End Resistance
 R < 50K ohms 30 ohms max.
 R ≥ 50K ohms 0.1 % of TR max.
 Insulation Resistance @ 250 VDC
 100 megohms min.
 Dielectric Withstanding Voltage
 300 VAC
 Tracking Error (-40 dB to 0 dB) ±3 dB
 Standard Taper Linear, Audio
 Power Rating
 Linear 0.05 watt
 Audio 0.025 watt
 Slider Noise 100 mV max.
 Operating Voltage 50 VAC / 10 VDC

Environmental Characteristics

Operational Life 15,000 cycles
 TR Shift ±15 %
 Operating Temperature Range
 -10 °C to +55 °C
 Resistance to Solder Heat ±5 %
 IP Rating IP 40

Mechanical Characteristics

Mechanical Angle 310 ° max.
 Operating Torque 20~250 gf-cm
 Stop Strength 4 kgf-cm max.
 Mounting Torque 10 kgf-cm max.
 Shaft Push Latch Force 40~500 gf
 Push Latch Operating Life
 10,000 cycles
 Soldering Condition
 Manual 300 °C ±5 °C for 3 sec.
 Wave 260 °C ±5 °C for 5 sec.
 Wash Not recommended
 Hardware One flat washer and
 one mounting nut supplied with
 each potentiometer

Standard Resistance Table

Resistance (Ohms)	Resistance Code
1,000	102
2,000	202
5,000	502
10,000	103
20,000	203
50,000	503
100,000	104
200,000	204
500,000	504
1,000,000	105

Product Dimensions

(Shown with Knurled Shaft)

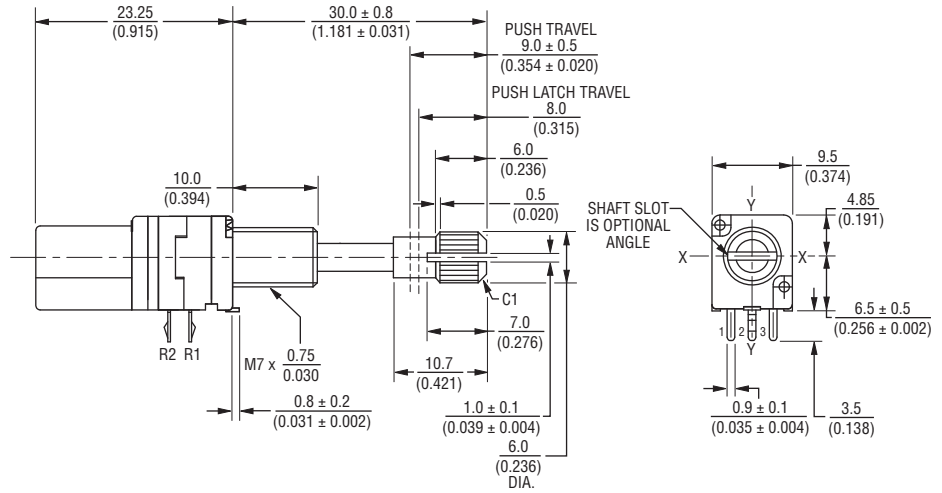

Mounting Hole Detail

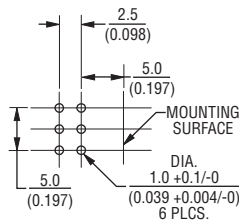

Locating Lug Detail

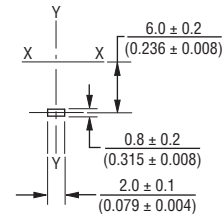

Hardware

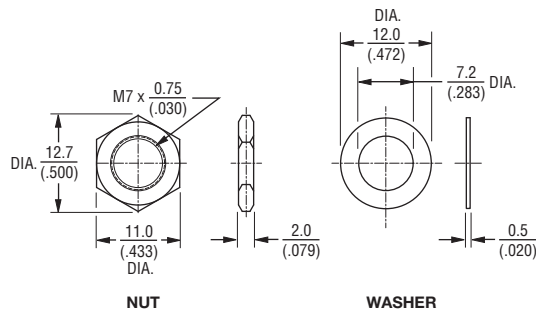

DIMENSIONS: $\frac{\text{MM}}{\text{(INCHES)}}$

*RoHS Directive 2002/95/EC Jan. 27, 2003 including annex and RoHS Recast 2011/65/EU June 8, 2011.

Specifications are subject to change without notice.

The device characteristics and parameters in this data sheet can and do vary in different applications and actual device performance may vary over time.

Users should verify actual device performance in their specific applications.

Applications

- Multimedia sound systems
- Mixers / drum machines / DJ equipment
- Automotive sound systems
- Portable electronics
- Portable appliances

PTP90 Series Panel Control w/Push Latching Shaft **BOURNS®**

Additional Shaft Styles

Flatted Shaft

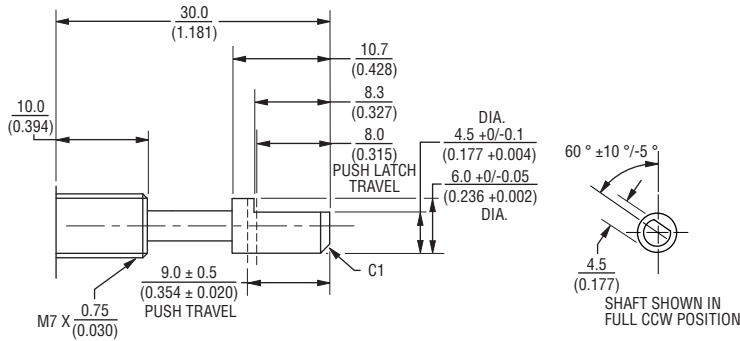

Slotted Shaft

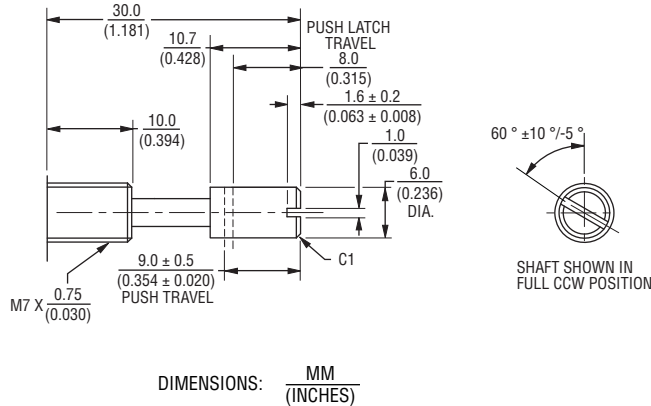

DIMENSIONS: $\frac{\text{MM}}{\text{(INCHES)}}$

How To Order

PTP90 2 - 0 30 K - 103 B2

- Model Number
- Designator
PTP90 = Panel Control w/Push Latching Shaft
- Number of Sections
1 = Single Gang
2 = Dual Gang
- Center Detent
0 = No Detent
1 = Center Detent
- Shaft Length (FMS)
30 = 30 mm
- Shaft Style
F = Flatted Metal
K = Knurled (18 tooth serrated)
S = Slotted Metal
- Resistance Code
(See Standard Resistance Table)
- Resistance Taper (See Taper Charts)
Taper Series followed by Curve Number

Schematics

Single Gang

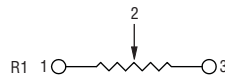

Dual Gang

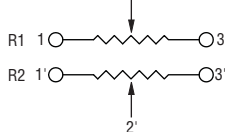

Tapers

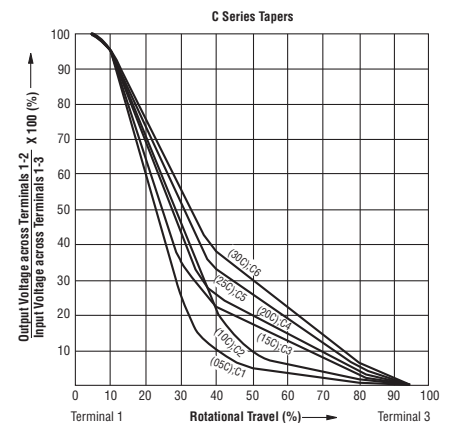
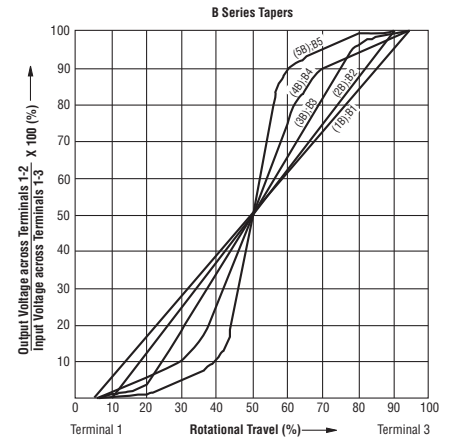
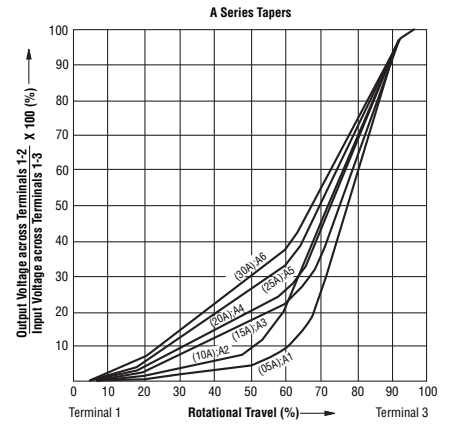

REV. 02/15

Specifications are subject to change without notice. The device characteristics and parameters in this data sheet can and do vary in different applications and actual device performance may vary over time. Users should verify actual device performance in their specific applications.