



Chipsmall Limited consists of a professional team with an average of over 10 year of expertise in the distribution of electronic components. Based in Hongkong, we have already established firm and mutual-benefit business relationships with customers from,Europe,America and south Asia,supplying obsolete and hard-to-find components to meet their specific needs.

With the principle of "Quality Parts,Customers Priority,Honest Operation,and Considerate Service",our business mainly focus on the distribution of electronic components. Line cards we deal with include Microchip,ALPS,ROHM,Xilinx,Pulse,ON,Everlight and Freescale. Main products comprise IC,Modules,Potentiometer,IC Socket,Relay,Connector.Our parts cover such applications as commercial,industrial, and automotives areas.

We are looking forward to setting up business relationship with you and hope to provide you with the best service and solution. Let us make a better world for our industry!



Contact us

Tel: +86-755-8981 8866 Fax: +86-755-8427 6832

Email & Skype: info@chipsmall.com Web: www.chipsmall.com

Address: A1208, Overseas Decoration Building, #122 Zhenhua RD., Futian, Shenzhen, China



60 Volt DC Radial Leaded, PolyTron™ PTC Devices

PolyTron™ PTR060V Series



Radial Leaded Device

Description

- PolyTron™ radial leaded thru-hole PTC device
- Maximum 60 volts
- Current ratings from 0.10 to 3.75 amps
- Fast time-to-trip
- Low resistance
- Halogen free
- Lead free
- RoHS compliant

Agency Information

- cURus: Recognized Card: File E343021 (I_{hold} 0.1-3.75A)
- TUV File: J 50194729

Part Number System/Ordering

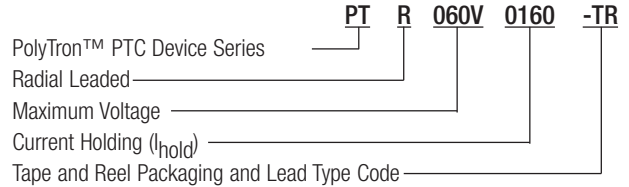

Lead Codes: TR & BK - Straight Leads, TR1 & BK1 - Kinked Leads

TR & TR1 On Reels

- 0.10, 0.20-0.40A - 3000 devices
- 0.17 - 2,500A devices
- 0.50-0.90A - 2000 devices
- 1.10-1.85A - 1500 devices
- 2.50-3.75A - 1000 devices

BK & BK1 In Poly Bags

- 0.10-0.25A - 1000 devices
- 0.30-1.85A - 500 devices
- 2.50-3.75A - 250 devices

Applications

- Medical equipment
- Industrial power transmission
- Computers and peripherals
- Rechargeable battery packs
- White goods
- Telecommunications
- Consumer and automotive electronics

Specifications

Catalog Number	V _{max} (Vdc)	I _{max} (Amps)	I _{hold} @23°C (Amps)	I _{trip} @23°C (Amps)	P _d Typ. (W)	Time to Trip (Max.)		Resistance (Ω)			Agency Information	
								Initial (R _i)		Post Trip (R ₁) Max.		
						(Amps)	(Sec)	Min.	Max.		cURus	TUV
PTR060V0010	60	40	0.10	0.20	0.38	0.50	4.0	2.500	4.500	7.50	X	X
PTR060V0017	60	40	0.17	0.34	0.48	0.85	3.0	3.300	5.210	8.00	X	X
PTR060V0020	60	40	0.20	0.40	0.41	1.00	2.2	1.830	2.750	4.40	X	X
PTR060V0025	60	40	0.25	0.50	0.45	1.25	2.5	1.250	1.950	3.00	X	X
PTR060V0030	60	40	0.30	0.60	0.49	1.50	3.0	0.880	1.330	2.10	X	X
PTR060V0040	60	40	0.40	0.80	0.56	2.00	3.8	0.550	0.860	1.29	X	X
PTR060V0050	60	40	0.50	1.00	0.77	2.50	4.0	0.500	0.770	1.17	X	X
PTR060V0065	60	40	0.65	1.30	0.88	3.25	5.3	0.310	0.480	0.72	X	X
PTR060V0075	60	40	0.75	1.50	0.92	3.75	6.3	0.250	0.400	0.60	X	X
PTR060V0090	60	40	0.90	1.80	0.99	4.50	7.2	0.200	0.310	0.47	X	X
PTR060V0110	60	40	1.10	2.20	1.50	5.50	8.2	0.150	0.250	0.38	X	X
PTR060V0135	60	40	1.35	2.70	1.70	6.75	9.6	0.120	0.190	0.30	X	X
PTR060V0160	60	40	1.60	3.20	1.90	8.00	11.4	0.090	0.140	0.22	X	X
PTR060V0185	60	40	1.85	3.70	2.10	9.25	12.6	0.080	0.120	0.19	X	X
PTR060V0250	60	40	2.50	5.00	2.50	12.50	15.6	0.050	0.080	0.13	X	X
PTR060V0300	60	40	3.00	6.00	2.80	15.00	19.8	0.040	0.060	0.10	X	X
PTR060V0375	60	40	3.75	7.50	3.20	18.75	24.0	0.030	0.050	0.08	X	X

Notes: I_{hold} – Hold current: Maximum current device will pass without interruption in 23°C still air.
I_{trip} – Trip current: Minimum current that will switch the device from low resistance to high resistance in 23°C still air.
V_{max}: Maximum continuous voltage device can withstand without damage at rated current.
I_{max}: Maximum fault current device can withstand without damage at rated voltage.
P_d: Power dissipated from device when in the tripped state in 23°C still air.
R_i (min.): Minimum resistance of device as supplied at 23°C unless otherwise specified.
R_i (max.): Maximum resistance of device as supplied at 23°C unless otherwise specified.
R₁ (max.): Maximum resistance of device when measured one hour post reflow (SMD) or one hour post trip (radial-leaded device) at 23°C unless otherwise specified.

Dimensions - mm

Part Number	A Max.	B Max Lead Type		C	D Min.	E Max.	F	Figure/Lead Style	
		Straight (-TR)	Kink (-TR1)					Straight TR	Kink TR1
PTR060V0010	7.4	12.7	12.7	5.0±0.8	7.6	3.0	0.5±0.02	2	1
PTR060V0017	7.4	12.7	12.7	5.0±0.8	7.6	3.0	0.5±0.02	2	1
PTR060V0020	7.4	12.2	12.2	5.0±0.8	7.6	3.0	0.5±0.02	2	1
PTR060V0025	7.4	12.7	12.7	5.0±0.8	7.6	3.0	0.5±0.02	2	1
PTR060V0030	7.4	13.0	13.0	5.0±0.8	7.6	3.0	0.5±0.02	2	1
PTR060V0040	7.6	13.5	13.5	5.0±0.8	7.6	3.0	0.5±0.02	2	1
PTR060V0050	7.6	13.7	13.7	5.0±0.8	7.6	3.0	0.5±0.02	2	1
PTR060V0065	9.7	14.5	14.5	5.0±0.8	7.6	3.0	0.5±0.02	2	1
PTR060V0075	10.4	15.2	15.2	5.0±0.8	7.6	3.0	0.5±0.02	2	1
PTR060V0090	11.7	15.7	15.7	5.0±0.8	7.6	3.0	0.5±0.02	2	1
PTR060V0110	13.0	18.0	18.0	5.0±0.8	7.6	3.0	0.8±0.02	2	1
PTR060V0135	14.5	19.6	19.6	5.0±0.8	7.6	3.0	0.8±0.02	2	1
PTR060V0160	16.3	21.3	21.3	5.0±0.8	7.6	3.0	0.8±0.02	2	1
PTR060V0185	17.8	22.9	22.9	5.0±0.8	7.6	3.0	0.8±0.02	2	1
PTR060V0250	21.3	26.4	26.4	10.0±0.8	7.6	3.0	0.8±0.02	2	1
PTR060V0300	24.9	30.0	30.0	10.0±0.8	7.6	3.0	0.8±0.02	2	1
PTR060V0375	28.4	33.5	33.5	10.0±0.8	7.6	3.0	0.8±0.02	2	1

Style 1

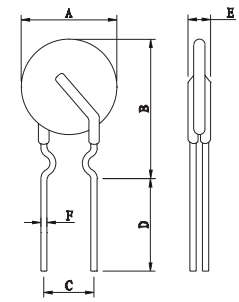

Style 2

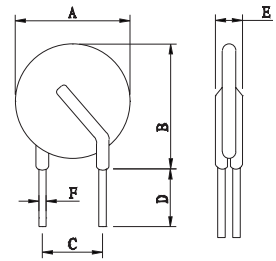

Time-to-Trip Curves at 23°C

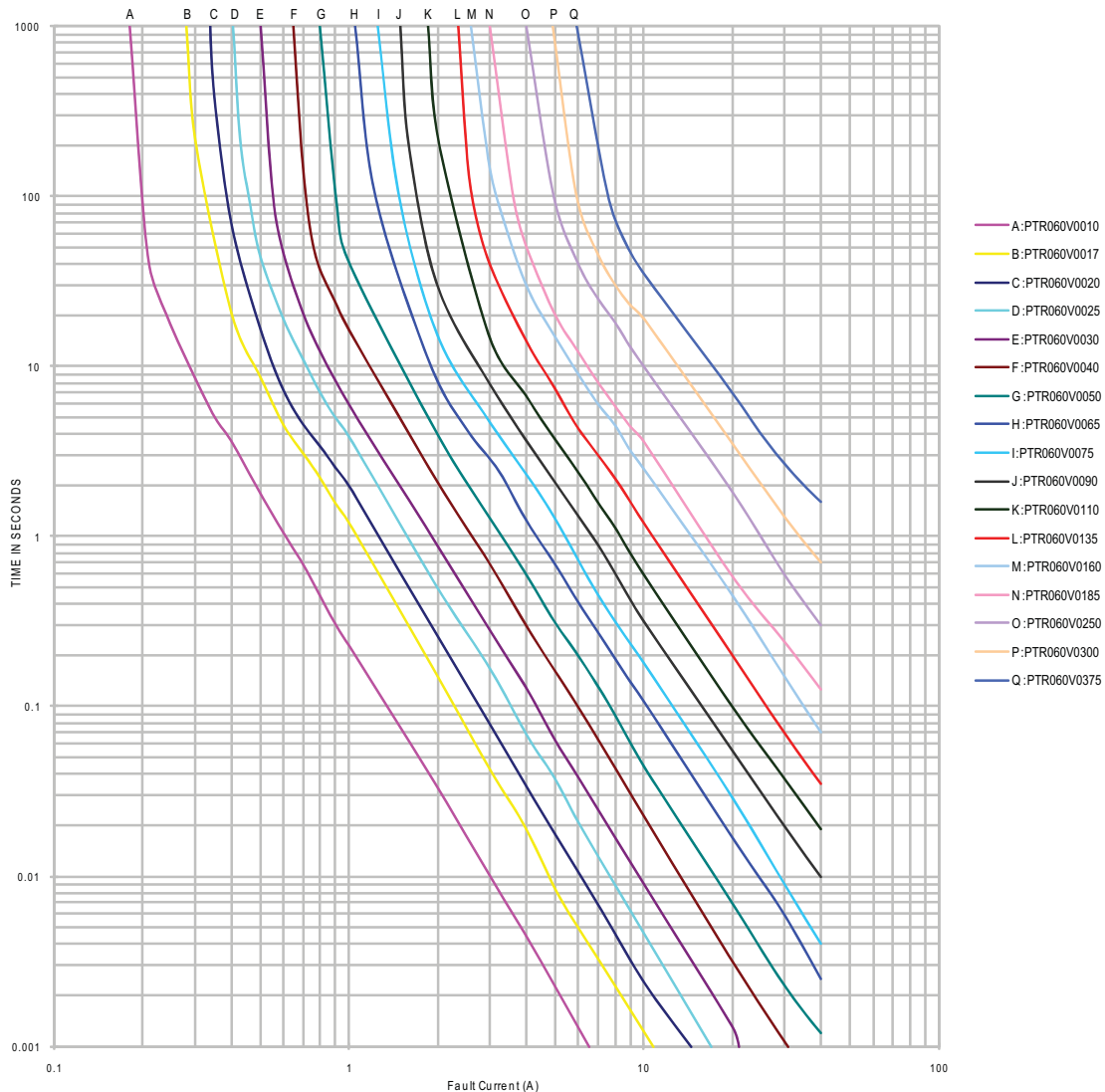

Thermal Derating Curve

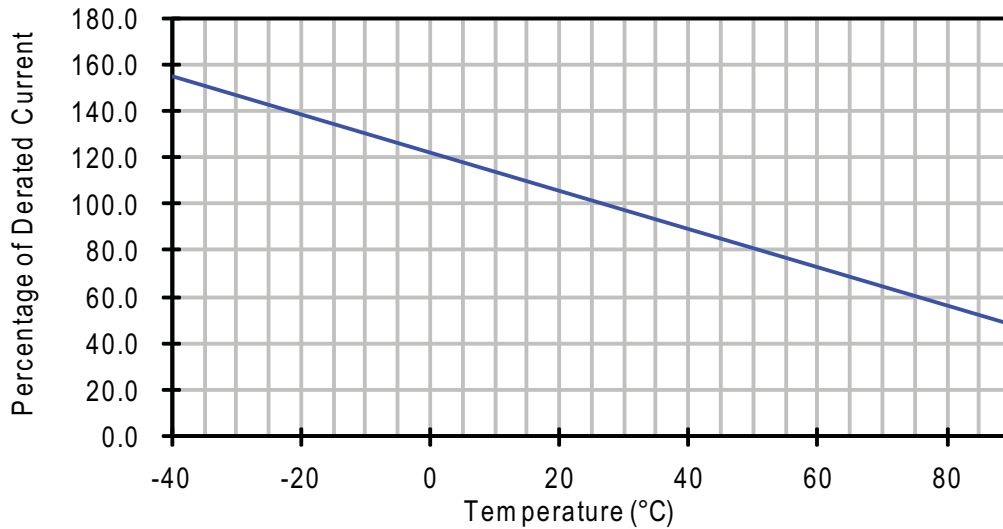

Recommended Wave Solder Profile.

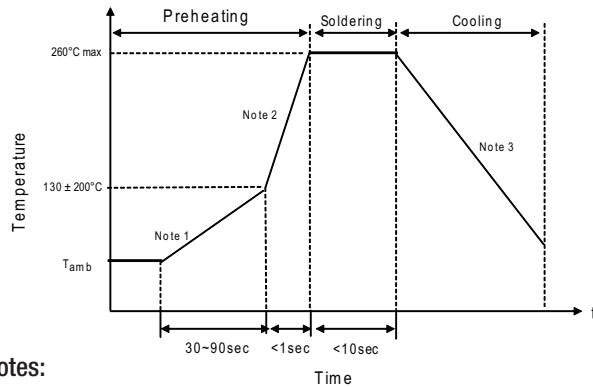

Notes:

1. (1-3) $^\circ\text{C}/\text{sec}$
2. Approximately $200^\circ\text{C}/\text{sec}$
3. $5^\circ\text{C}/\text{sec}$ Maximum

Recommended Reworking Conditions with Soldering Iron

- Soldering Iron Tip Temperature: 360°C max.
- Solder Time: 3 seconds max.
- Distance from Thermistor: 2mm min.

Environmental Specifications	
Characteristic	Value
Operating Temperature Range	-40°C to $+85^\circ\text{C}$
Surface Temperature Trip State	125°C max.
Thermal Shock	$+85^\circ\text{C}$ to -40°C , 10 cycles, 5% typical resistance change
Solvent Resistance	MIL-STD-202 Method 215, no change
Humidity Age Test	$+85^\circ\text{C}$, 85% R.H., 1000 hours $\pm 5\%$ typical resistance change. Specified temperature ($23^\circ\text{C} \pm 3^\circ\text{C}$)
Storage Temperature Range	-10°C to $+40^\circ\text{C}$
Storage Duration	One year
Storage Relative Humidity	$\leq 75\%$
Storage Conditions	Keep away from corrosive atmosphere and sunlight

Material Composition

- Lead material:
 - PTR060V0010-PTR060V0040 Tin-plated copper clad steel
 - PTR060V0050-PTR060V0375 Tin-plated copper
- Insulating material: Cured epoxy resin meeting UL 94V0 requirements

Packaging/Taping Specifications

Description	IEC Mark	Dimension (mm)	Tolerance (mm)
Sprocket hole pitch PO 12.7 0.3			
Ordinate to adjacent component lead PTR060V0010~PTR060V0090	P ₁	3.6	±1.0
Ordinate to adjacent component lead PTR060V0110~PTR060V0185	P ₁	3.45	±1.0
Ordinate to adjacent component lead PTR060V0250~PTR060V0300	P ₁	7.3	±1.0
Device pitch PTR060V0010~PTR060V0090	P	12.7	±1.0
Device pitch PTR060V0110~PTR060V0300	P	25.4	±1.0
Device pitch PTR060V0375	P	38.1	±1.0
Lead spacing	C	*	--
Carrier tape width	W	18	±1.0
Top distance between tape edges	W ₀	3.0	Max.
Hold-down tape width	W ₁	12	±1.0
Sprocket hole position	W ₂	9.0	+0.75/-0.5
Abscissa to top PTR060V0010~PTR060V0090	H ₁	32.2	Max.
Abscissa to top PTR060V0110~PTR060V0300	H ₁	47.5	Max.
Abscissa to plane (straight lead)	H	18.0	+2/-0
Abscissa to plane (kinked lead)	H ₀	16.0	±0.5
Sprocket hole diameter	D ₀	4	±0.2
Lead protrusion	L ₁	1	Max.
Tape thickness	t	0.9	Max.
Body lateral deviation	Δh	0	±1.0
Body tape plane deviation	Δp	0	±1.3
Reel width	W ₃	56	Max.
Reel diameter		340	±10
Arbor hole diameter	n ₀	31	±1
Core diameter	n	80	Min.

* See Dimensions table.

Figure 1 - PTR060V0010-PTR060V0185

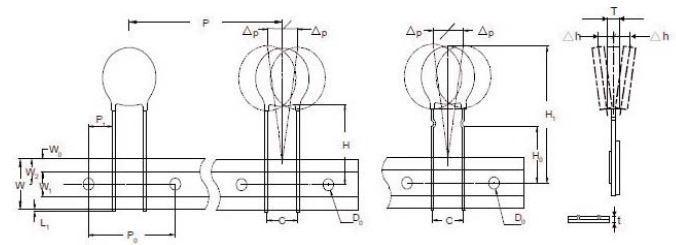
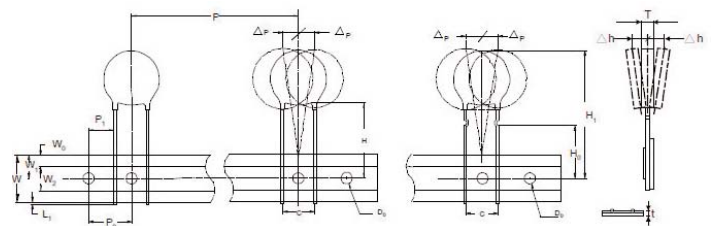
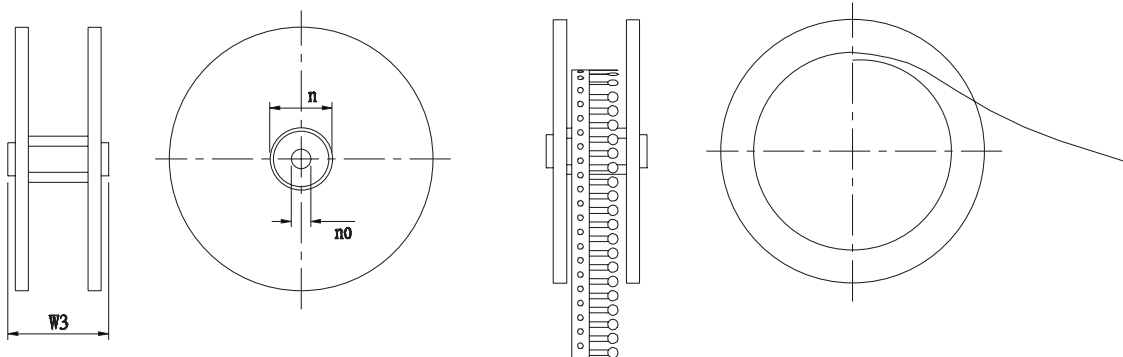

Figure 2 - PTR060V0250-PTR060V0375



Reel Specifications



The only controlled copy of this Data Sheet is the electronic read-only version located on the Cooper Bussmann Network Drive. All other copies of this document are by definition uncontrolled. This bulletin is intended to clearly present comprehensive product data and provide technical information that will help the end user with design applications. Cooper Bussmann reserves the right, without notice, to change design or construction of any products and to discontinue or limit distribution of any products. Cooper Bussmann also reserves the right to change or update, without notice, any technical information contained in this bulletin. Once a product has been selected, it should be tested by the user in all possible applications.

Life Support Policy: Cooper Bussmann does not authorize the use of any of its products for use in life support devices or systems without the express written approval of an officer of the Company. Life support systems are devices which support or sustain life, and whose failure to perform, when properly used in accordance with instructions for use provided in the labeling, can be reasonably expected to result in significant injury to the user.