



Chipsmall Limited consists of a professional team with an average of over 10 year of expertise in the distribution of electronic components. Based in Hongkong, we have already established firm and mutual-benefit business relationships with customers from,Europe,America and south Asia,supplying obsolete and hard-to-find components to meet their specific needs.

With the principle of "Quality Parts,Customers Priority,Honest Operation,and Considerate Service",our business mainly focus on the distribution of electronic components. Line cards we deal with include Microchip,ALPS,ROHM,Xilinx,Pulse,ON,Everlight and Freescale. Main products comprise IC,Modules,Potentiometer,IC Socket,Relay,Connector.Our parts cover such applications as commercial,industrial, and automotives areas.

We are looking forward to setting up business relationship with you and hope to provide you with the best service and solution. Let us make a better world for our industry!



Contact us

Tel: +86-755-8981 8866 Fax: +86-755-8427 6832

Email & Skype: info@chipsmall.com Web: www.chipsmall.com

Address: A1208, Overseas Decoration Building, #122 Zhenhua RD., Futian, Shenzhen, China



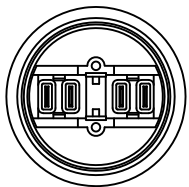
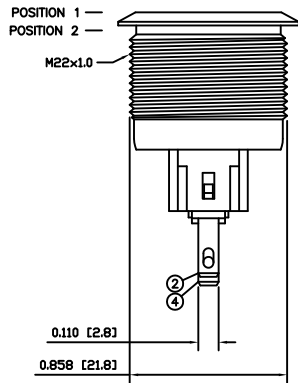
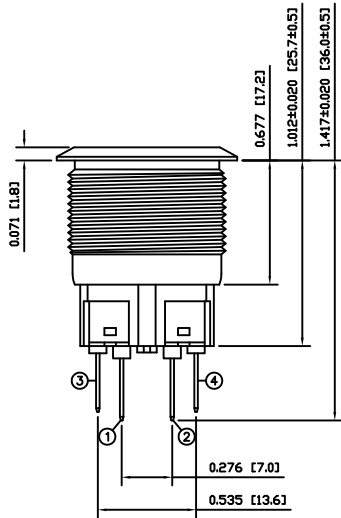
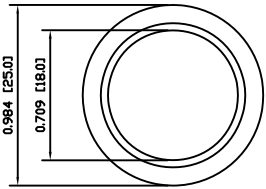

SUGGESTED PANEL CUTOUT

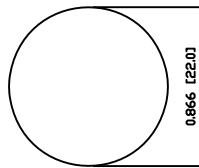

MAXIMUM PANEL THICKNESS: 0.315 [8.0mm]

SCHMATIC

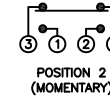
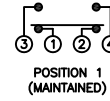

SPECIFICATIONS

FUNCTION:
1PNO OFF-(ON) + 1PNC ON-(OFF)

RATING:
2A 48VDC

CONTACT RESISTANCE:
Initial: 50mΩ Max. at 1A 12VDC

INSULATION RESISTANCE:
1,000MΩ Min. at 500VDC

DIELECTRIC STRENGTH:
2,000VAC Min. for 1 Minute

ELECTRICAL LIFE:
50,000 Cycles

MECHANICAL LIFE:
1,000,000 Cycles

TEMPERATURE:
Operating: -20°C to 70°C

INGRESS PROTECTION:
IP65

APPROVALS:
RoHS
COMPLIANT

MATERIALS

BUSHING:
Stainless Steel (304)

BASE:
Polyamide 6/6 (PA66)

ACTUATOR:
Stainless Steel (304)

HARDWARE:
Nickel Plated Brass (H59)

SEALING:
Silicone Rubber

INNER ASSEMBLY:
Polycarbonate (PC)
Polyoxymethylene (POM)
Brass (H62)
Stainless Steel (304)

SPRING:
Stainless Steel (304)

CONTACTS:
Silver/Cadmium Oxide (AgCdO)

TERMINALS:
Brass (H62)

O-RING:
Silicone Rubber

COLORS AND FINISH

BEZEL:
Stainless Steel
Machine Finish

ACTUATOR:
Stainless Steel
Machine Finish

ILLUMINATION:
None

MARKING:
None

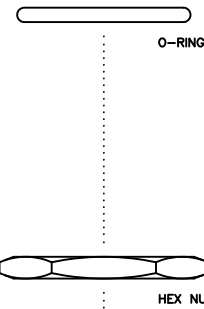
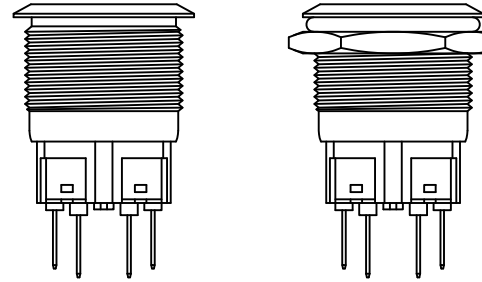

EXPLODED VIEW

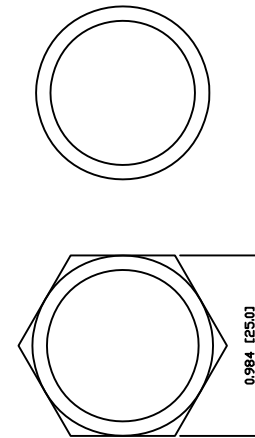

ASSEMBLED VIEW

BODY	A	09/07/22	CAB
COLORS	A	09/07/22	CAB
MATERIALS	B	09/12/02	CAB
SPECIFICATIONS	B	09/12/29	CAB
REFERENCE	REV.	DATE	BY

THE INFORMATION CONTAINED IN THIS DOCUMENT IS PROPRIETARY TO E-SWITCH AND IS NOT TO BE COPIED OR TRANSFERRED

INITIAL RELEASE	20018	11/06/20	CAB
DESCRIPTION	PCR	DATE	DRAWN BY

DIMENSIONS	INCHES [MILLIMETERS]
GENERAL TOLERANCES	±0.008 [±0.2] / ±1'
SCALE	DRAWING NOT TO SCALE
PROJECTION	1st Angle

TITLE		
PV7F2Y0SS		
ITEM NUMBER	DATE	REVISION
52-PV7F2Y0SS	JUNE 20, 2011	A