



Chipsmall Limited consists of a professional team with an average of over 10 year of expertise in the distribution of electronic components. Based in Hongkong, we have already established firm and mutual-benefit business relationships with customers from,Europe,America and south Asia,supplying obsolete and hard-to-find components to meet their specific needs.

With the principle of “Quality Parts,Customers Priority,Honest Operation,and Considerate Service”,our business mainly focus on the distribution of electronic components. Line cards we deal with include Microchip,ALPS,ROHM,Xilinx,Pulse,ON,Everlight and Freescale. Main products comprise IC,Modules,Potentiometer,IC Socket,Relay,Connector.Our parts cover such applications as commercial,industrial, and automotives areas.

We are looking forward to setting up business relationship with you and hope to provide you with the best service and solution. Let us make a better world for our industry!



Contact us

Tel: +86-755-8981 8866 Fax: +86-755-8427 6832

Email & Skype: info@chipsmall.com Web: www.chipsmall.com

Address: A1208, Overseas Decoration Building, #122 Zhenhua RD., Futian, Shenzhen, China



This part is now OBSOLETE 1/22/2009

Not Recommended for new designs

International
IR Rectifier

Data Sheet No. PD 10057 revN

Series PVY116 & PbF

Microelectronic Power IC
HEXFET® Power MOSFET Photovoltaic Relay
Single-Pole, Normally-Open, 0-40V AC/DC, 250mA

General Description

The PVY116 Series Photovoltaic Relay is a single-pole, normally-open solid-state relay that can replace dry and Mercury-wetted reed relays in many applications. It utilizes International Rectifier's proprietary HEXFET power MOSFET as the output switch, driven by an integrated circuit photovoltaic generator of novel construction. The output switch is controlled by radiation from a GaAlAs light emitting diode (LED), which is optically isolated from the photovoltaic generator.

The PVY116 is ideally suited for use as matrix relay in low voltage ATE applications and general instrumentation applications involving high frequency test signals. This can be accomplished thanks to the extremely low Figure Of Merit ($FOM = Coff * Ron$), which is the product of the relay's off-state output capacitance and on-state resistance.

The PVY116 is packaged in a 4-pin, molded small outline package (SOP-4) with surface mount (gull wing) terminals. It is available in plastic shipping tubes or on tape-and-reel. Please refer to Part Identification information.

Applications

- Automated Test Equipment
- Instrumentation
- Data Acquisition

Features

- Low signal distortion at high frequencies
- Low $Coff * Ron$ Figure Of Merit
- High off-state resistance
- Bounce-free operation
- 1,500 V_{RMS} I/O isolation
- Long operational life
- Solid-State Reliability
- ESD Tolerance 2000V Human Body Mode

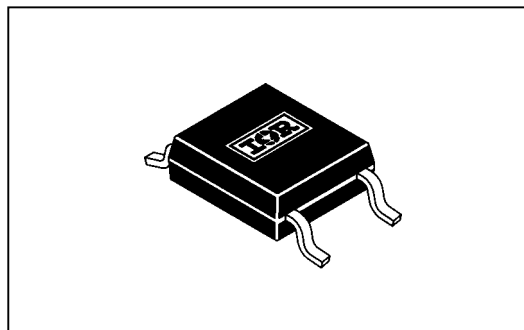

Part Identification

PVY116 & PbF	surface-mount
PVY116-T & PbF	surface-mount, tape-and-reel

(HEXFET is the registered trademark for International Rectifier's power MOSFETs)

Electrical Specifications ($-40^{\circ}\text{C} \leq T_A \leq +85^{\circ}\text{C}$ unless otherwise specified)

INPUT CHARACTERISTICS	Units	Min	Typ	Max
Minimum control current (see Figure 1)	mA	2.0	—	—
Control current for off-state resistance @ $T_A = +25^{\circ}\text{C}$	mA	—	—	0.2
Control current range (caution: current limit input LED, see Figure 8)	mA	2.0	—	20.0
Reverse voltage	V	—	—	6.0

OUTPUT CHARACTERISTICS	Units	Min	Typ	Max
Operating voltage range	V peak	—	—	40
Continuous load current @ 40°C , 5mA control (see Figure 1)	mA	—	—	250
Pulsed load current @ 25°C , 5mA control (see Figure 2 and 3) 10ms on, 10% duty cycle	mA	—	—	420
Off-state leakage @ 32V, 25°C , (see Figure 4)	nA	—	0.02	1.0
On-state resistance @ 5mA control, $I_L = 100\text{mA}$ (see Figure 2 and 3)	Ω	—	3.8	4.4
Output capacitance $V_d = 0\text{V}$, $f = 1\text{MHz}$ (C_{out} , see Figure 7)	pF	—	2.4	3.0
$C * R$ (RDDon x C_{out})	pF * Ω	—	9.1	—
Turn-on time, 5mA control, 100Ω , 20V (T_{on} , see Figure 5) 1ms on, 50% duty cycle	μS	—	110	500
Turn-off time, 5mA control, 100Ω , 20V (T_{off} , see Figure 5) 1ms on, 50% duty cycle	μS	—	100	500

GENERAL CHARACTERISTICS	Units	Min	Typ	Max
Dielectric strength, Input to Output	V_{RMS}	1500	—	—
Insulation Resistance, Input to Output	Ω	10^{12}	—	—
C_{I-O} (Input to Output Capacitance), $V_d = 0\text{V}$, $f = 1\text{MHz}$	pF	—	0.8	—
Max. pin soldering temperature (10 seconds max.)	$^{\circ}\text{C}$			+260
Ambient temperature range: Operating	$^{\circ}\text{C}$	-40		+85
Storage	$^{\circ}\text{C}$	-40		+100

International Rectifier does not recommend the use of this product in aerospace, avionics, military or life support applications. Users of this International Rectifier product in such applications assume all risks of such use and indemnify International Rectifier against all damages resulting from such use.

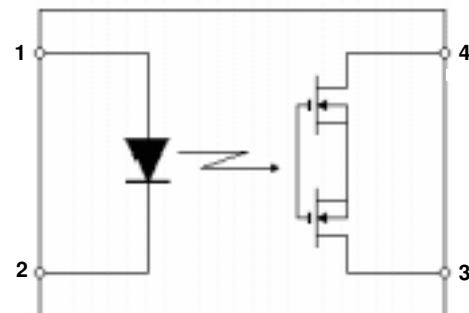

Connection Diagram

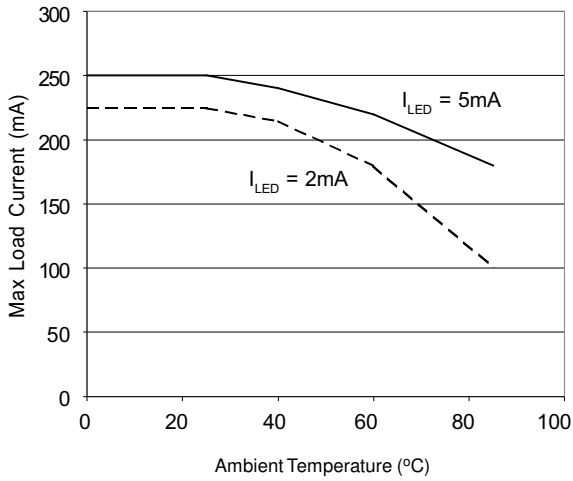

Figure 1. Current Derating Curves

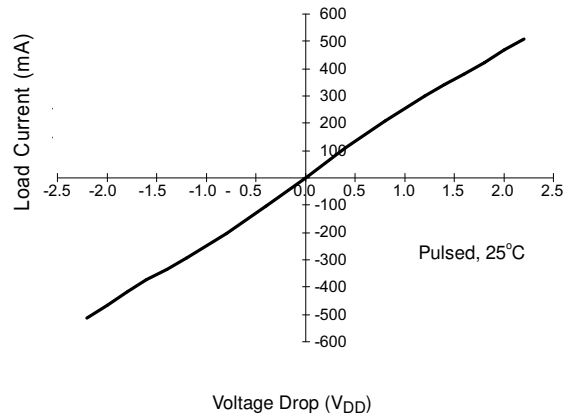

Figure 2. Typical On Characteristics

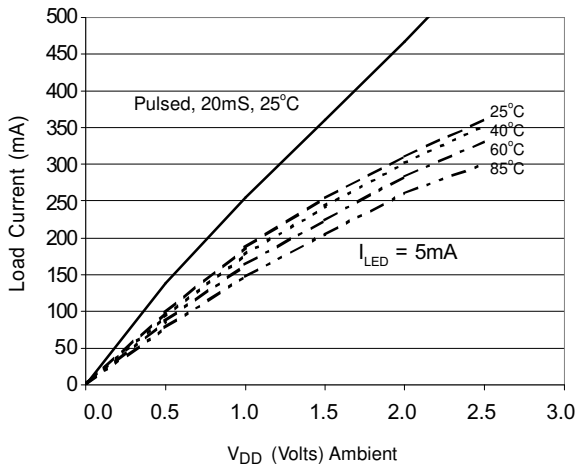

Figure 3. Typical On Characteristics

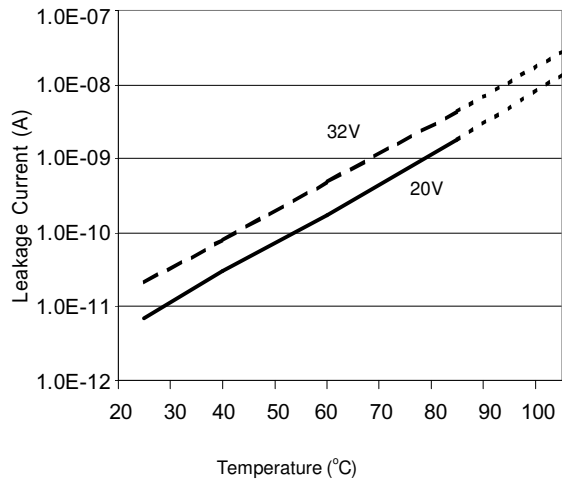

Figure 4. Typical Leakage Characteristics

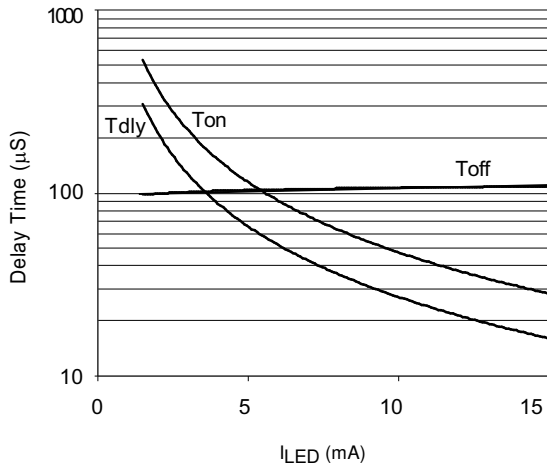

Figure 5. Typical Delay Times

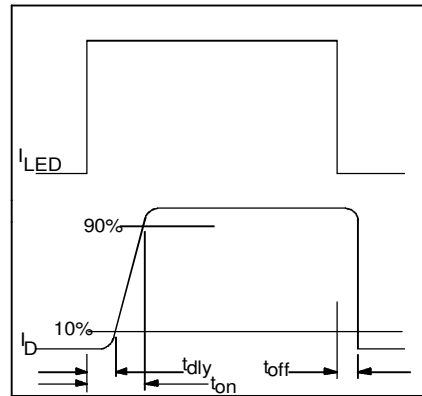

Figure 6. Delay Time Definitions

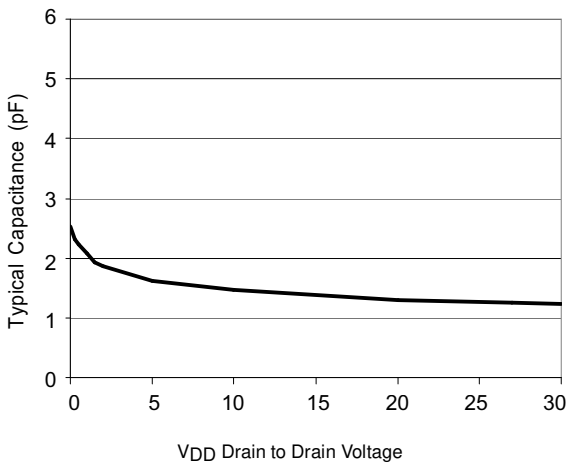

Figure 7. Output Capacitance

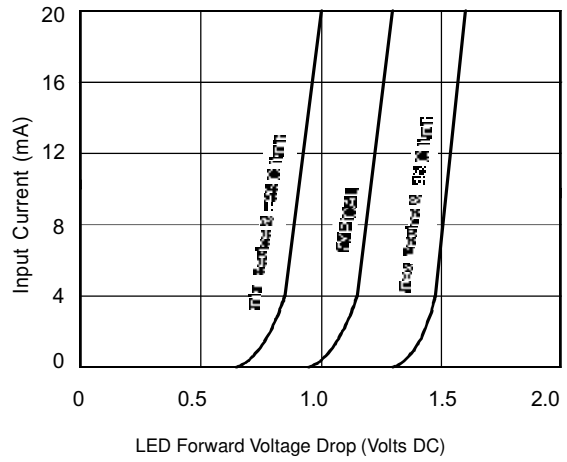

Figure 8. Input Characteristics (Current Controlled)

Case Outlines - 4 Lead SOP

