



Chipsmall Limited consists of a professional team with an average of over 10 year of expertise in the distribution of electronic components. Based in Hongkong, we have already established firm and mutual-benefit business relationships with customers from,Europe,America and south Asia,supplying obsolete and hard-to-find components to meet their specific needs.

With the principle of "Quality Parts,Customers Priority,Honest Operation,and Considerate Service",our business mainly focus on the distribution of electronic components. Line cards we deal with include Microchip,ALPS,ROHM,Xilinx,Pulse,ON,Everlight and Freescale. Main products comprise IC,Modules,Potentiometer,IC Socket,Relay,Connector.Our parts cover such applications as commercial,industrial, and automotives areas.

We are looking forward to setting up business relationship with you and hope to provide you with the best service and solution. Let us make a better world for our industry!



Contact us

Tel: +86-755-8981 8866 Fax: +86-755-8427 6832

Email & Skype: info@chipsmall.com Web: www.chipsmall.com

Address: A1208, Overseas Decoration Building, #122 Zhenhua RD., Futian, Shenzhen, China



- NOTES:
- 1.0 ELECTRICAL SPECIFICATIONS:
 - 1.1 FREQUENCY RANGE: 2.0 to 8.0 GHz
 - 1.2 INSERTION LOSS: .50dB MAX.
 - 1.3 ISOLATION: 20dB MIN
 - 1.4 VSWR (MAX): 1.35:1
 - 1.5 OUTPUT UNBALANCE:
 - 1.5.1 AMPLITUDE: 0.30dB MAX.
 - 1.5.2 PHASE: 4° MAX.
 - 1.6 MAX. INPUT POWER: 5 WATTS
 - 1.7 OPERATING TEMP. RANGE: -55°C to +125°C

- 2.0 FINISH
 - 2.1 GREY PER MIL-E-15090 TYPE II, CLASS 2
OVER MIL-C-5541 CLASS 3A
MEETS MIL-F-14072
MEETS MIL-E-5400

- 3.0 MARKING: MARK UNIT AS SHOWN.
SLK-08136-82-03

- 4.0 DIMENSIONS IN PARENTHESIS ARE
IN MILLIMETERS.

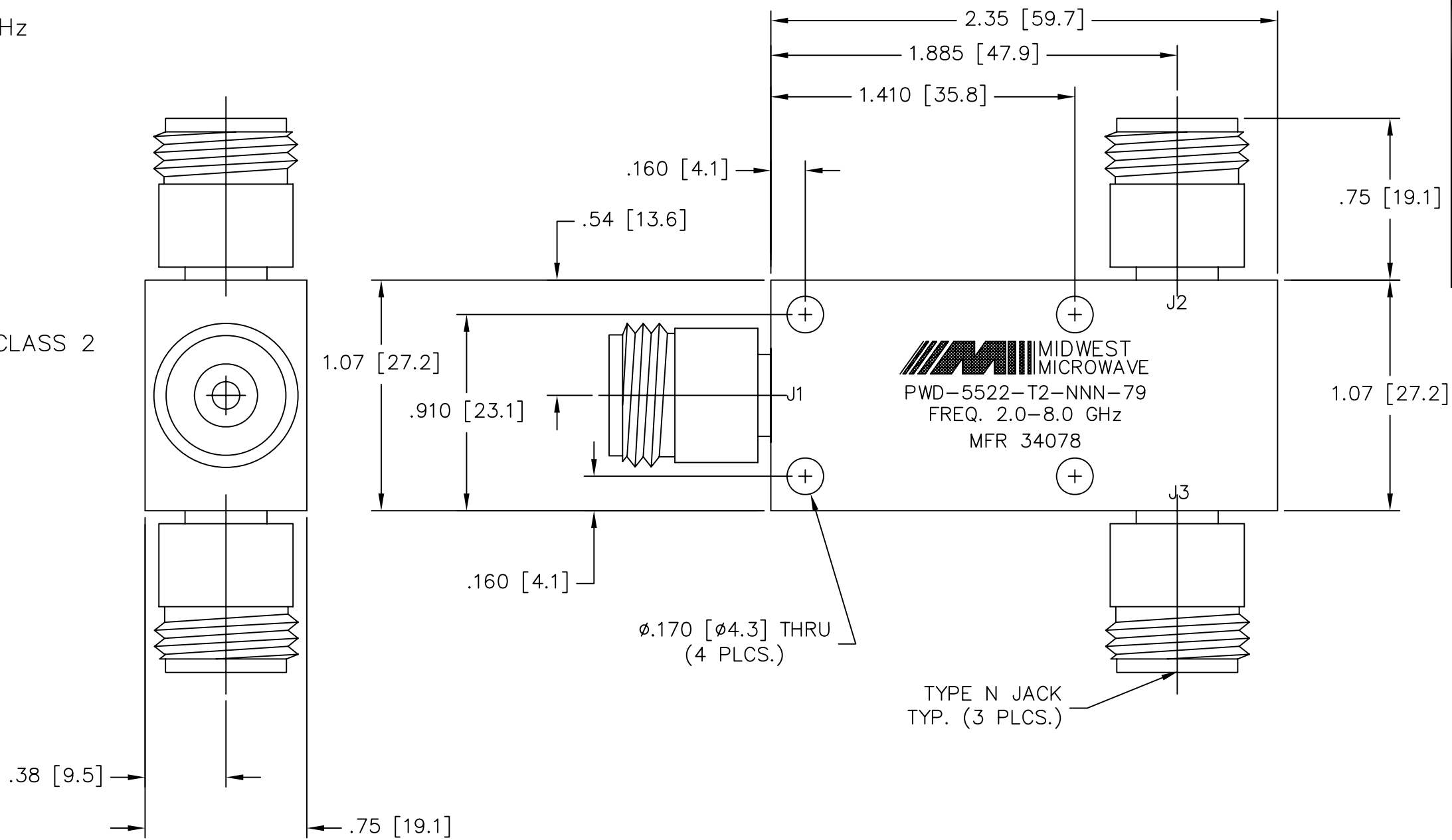

DATE	11/4/02
DESCRIPTION	RELEASED
REV.	-

UNLESS OTHERWISE NOTED DIMENSIONS ARE IN INCHES AND TOLERANCES ARE:	FSCM NO.	34078 MIDWEST MICROWAVE	
	3 PLACE DECIMALS ±.005 2 PLACE DECIMALS ±.02 FRACTIONS ±1/64 PARALLELITY: T.I.R. _____ FLATNESS: T.I.R. _____ CONCENTRICITY: T.I.R. _____ ANGLES AND PERPENDICULARITY: ±1°	NOTICE: The information contained in this drawing is proprietary and must not be used without the permission of Midwest Microwave	TITLE POWER DIVIDER
	DRAWN/DATE S.ORLOV 10/31/02	ENG./DATE B.GALLAGHER 10/31/02	DRAWING NUMBER PWD-5522-T2-NNN-79
	CHECKED/DATE	APPROVED/DATE	SCALE: 2=1 SHEET 1 of 1