



Chipsmall Limited consists of a professional team with an average of over 10 year of expertise in the distribution of electronic components. Based in Hongkong, we have already established firm and mutual-benefit business relationships with customers from,Europe,America and south Asia,supplying obsolete and hard-to-find components to meet their specific needs.

With the principle of “Quality Parts,Customers Priority,Honest Operation,and Considerate Service”,our business mainly focus on the distribution of electronic components. Line cards we deal with include Microchip,ALPS,ROHM,Xilinx,Pulse,ON,Everlight and Freescale. Main products comprise IC,Modules,Potentiometer,IC Socket,Relay,Connector.Our parts cover such applications as commercial,industrial, and automotives areas.

We are looking forward to setting up business relationship with you and hope to provide you with the best service and solution. Let us make a better world for our industry!



Contact us

Tel: +86-755-8981 8866 Fax: +86-755-8427 6832

Email & Skype: info@chipsmall.com Web: www.chipsmall.com

Address: A1208, Overseas Decoration Building, #122 Zhenhua RD., Futian, Shenzhen, China



2.5V LVDS Low Jitter XO

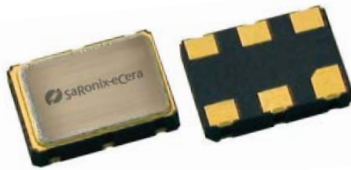

7.0 x 5.0mm Ceramic SMD

Product Features

- 38.88 to 162 MHz Frequency Range
- <1 ps RMS jitter with non-PLL design
- Designed for standard reflow & washing techniques
- IBIS models available
- Pb-free & RoHS/Green compliant

Product Description

The PX Series 2.5V crystal clock oscillator achieves superb jitter and stability over a broad range of operating conditions and frequencies. The output clock signal, generated internally with a non-PLL oscillator design, is compatible with LVDS logic levels. The device, available on tape and reel, is contained in a 7.0 x 5.0mm surface-mount ceramic package.

Applications

The PX Series is ideal for high-speed applications requiring low jitter, including:

- 1/10 Gigabit Ethernet
- 2/4/10G FibreChannel
- Serial Attached SCSI (SAS)
- Server & Storage platforms
- SONET/SDH linecards
- Passive Optical Network (PON) devices
- HD Video Systems

Package:

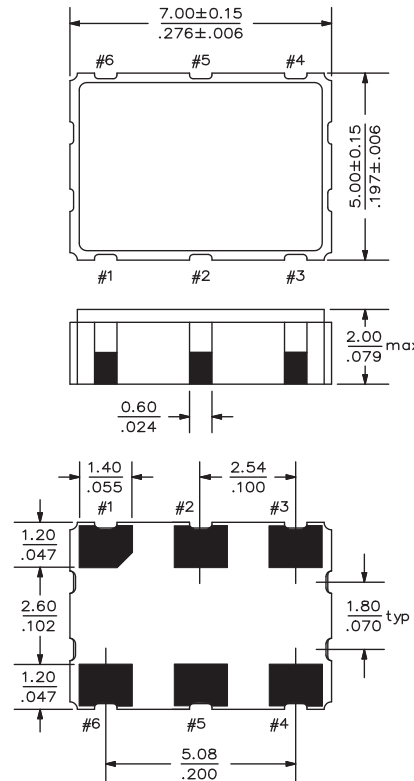

Recommended Land Pattern:

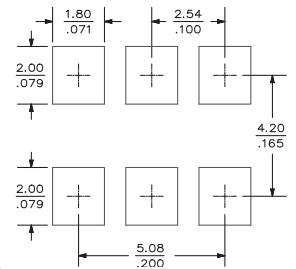

Pin Functions:

Pin	Function
1	OE or NC
2	OE or NC
3	Ground
4	Q Output
5	\bar{Q} Output
6	V _{CC}

Part Ordering Information:

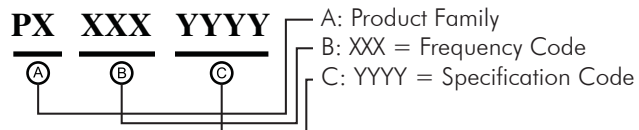

Following the above format, Saronix-eCera part numbers will be assigned upon confirmation of exact customer requirements.

Legacy Ordering Information - For Reference Only:

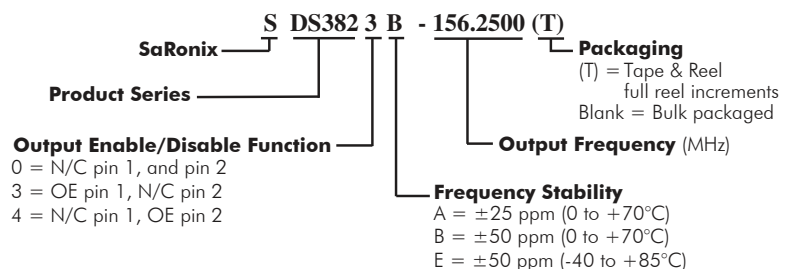

Electrical Performance

Parameter	Min.	Typ.	Max.	Units	Notes
Output Frequency	38.88		162	MHz	As specified
Supply Voltage	2.25	2.50	2.75	V	
Supply Current, Enabled		35	47	mA	
Supply Current, Disabled			0.03	mA	
Frequency Stability			±20 to ±50	ppm	See Note 1 below
Operating Temperature Range	-20		+70	°C	Commercial (standard)
	-40		+85		Industrial (standard)
Output Logic 0, V _{OL}	0.9	1.1		V	
Output Logic 1, V _{OH}		1.43	1.6	V	
Output Load	100Ω connected between both outputs				output requires termination
Duty Cycle	45		55	%	measured 50% of waveform
Rise and Fall Time		500	850	ps	measured 20/80% of waveform
Jitter, Phase		0.5	1	ps RMS (1-σ)	12kHz to 20MHz frequency band
Jitter, Total			25	ps pk-pk	100,000 random periods

Notes:

- Stability includes all combinations of operating temperature, load changes, rated input (supply) voltage changes, initial calibration tolerance (25°C), aging (5 year at 40°C average effective ambient temperature), shock and vibration.
- For specifications other than those listed, please contact sales.

Output Enable / Disable Function

Parameter	Min.	Typ.	Max.	Units	Notes
Input Voltage (pin OE), Output Enable	0.7			V	or open
Input Voltage (pin OE), Output Disable (low power standby)			0.3	V	Output disabled to Hi-Z
Internal Pullup Resistance	50			kΩ	
Output Disable Delay			200	ns	
Output Enable Delay			10	ms	

Absolute Maximum Ratings

Parameter	Min.	Typ.	Max.	Units	Notes
Storage Temperature	-55		+125	°C	

Test Circuit

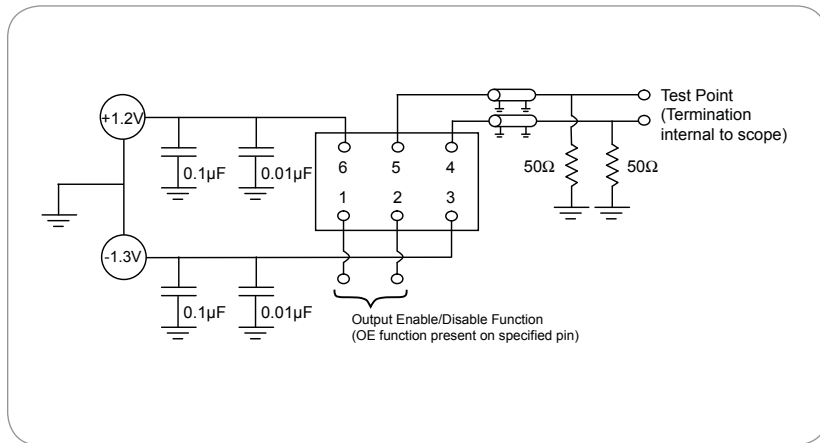

Reflow Soldering Profile

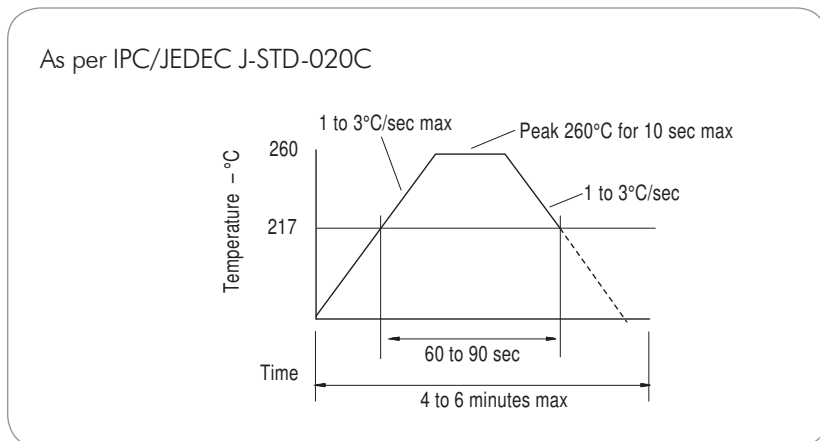

Reliability Test Ratings

This product is rated to meet the following test conditions:

Type	Parameter	Test Condition
Mechanical	Shock	MIL-STD-883, Method 2002, Condition B
Mechanical	Solderability	JESD22-B102-D Method 2 (Preconditioning E)
Mechanical	Terminal strength	MIL-STD-883, Method 2004, Condition D
Mechanical	Gross leak	MIL-STD-883, Method 1014, Condition C
Mechanical	Fine leak	MIL-STD-883, Method 1014, Condition A2 ($R_1 = 2 \times 10^{-8}$ atm cc/s)
Mechanical	Solvent resistance	MIL-STD-202, Method 215
Environmental	Thermal shock	MIL-STD-883, Method 1011, Condition A
Environmental	Moisture resistance	MIL-STD-883, Method 1004
Environmental	Vibration	MIL-STD-883, Method 2007, Condition A
Environmental	Resistance to soldering heat	J-STD-020C Table 5-2 Pb-free devices (2 cycles max)