



Chipsmall Limited consists of a professional team with an average of over 10 year of expertise in the distribution of electronic components. Based in Hongkong, we have already established firm and mutual-benefit business relationships with customers from,Europe,America and south Asia,supplying obsolete and hard-to-find components to meet their specific needs.

With the principle of “Quality Parts,Customers Priority,Honest Operation,and Considerate Service”,our business mainly focus on the distribution of electronic components. Line cards we deal with include Microchip,ALPS,ROHM,Xilinx,Pulse,ON,Everlight and Freescale. Main products comprise IC,Modules,Potentiometer,IC Socket,Relay,Connector.Our parts cover such applications as commercial,industrial, and automotives areas.

We are looking forward to setting up business relationship with you and hope to provide you with the best service and solution. Let us make a better world for our industry!



## Contact us

Tel: +86-755-8981 8866 Fax: +86-755-8427 6832

Email & Skype: info@chipsmall.com Web: www.chipsmall.com

Address: A1208, Overseas Decoration Building, #122 Zhenhua RD., Futian, Shenzhen, China



**PROPRIETARY INFORMATION:**  
 PROPRIETARY OF GLOBTEK, INC. ANY REPRODUCTION, DISCLOSURE OR USE OF THIS DRAWING, IN WHOLE OR IN PART, IS HEREBY PROHIBITED EXCEPT AS SPECIFIED IN WRITING BY GLOBTEK, INC.

REVISION			
REV	DESCRIPTION	DATE	APPROVED
A	INITIAL RELEASE, RFS.16559, CH	07/27/09	HM
B	ADD NOTE,RFS. 16810, CH	08/06/09	HM
C	UPDATE PACKING, RFS. 17671, CH	12/10/09	HM
D	UPDATE PACKING, RFS. 24373, SO	03/05/13	HM
E	ADD STANDARD RATED AT 5A/6A, RFS. 24659, JS	04/22/13	HM
F	UPDATE MECHANICAL DRAWING, RFS. 24839, BS	05/24/13	HM



STANDARD OPTION SHIPS WITHOUT AC PINS INSTALLED

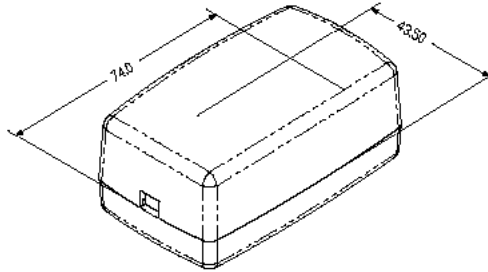
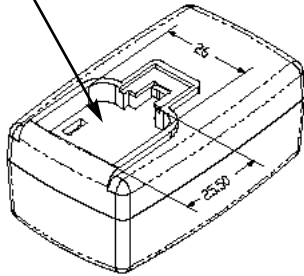

**1. MATERIAL**

HIGH IMPACT PLASTIC, 94V0 POLYCARBONATE, NON-VENTED, COLOR BLACK

**2. INPUT CONNECTOR:**

INDIA: STANDARD IS 1293, RATED 6A  
 SOUTH AFRICA: STANDARD SANS 164-3, RATED 5A/6A  
 BRITISH: STANDARD BS 546, RATED 5A

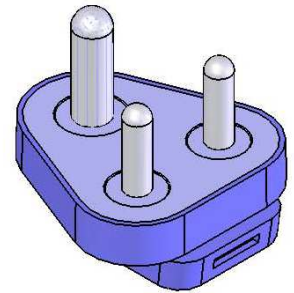
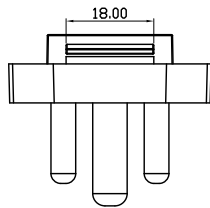

P/N: Q-IN(R)  
 INDIA  
 SOUTH AFRICA

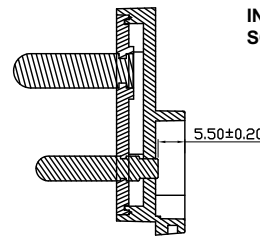
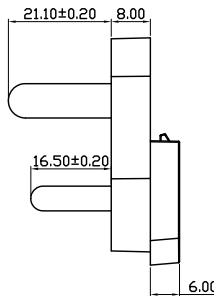
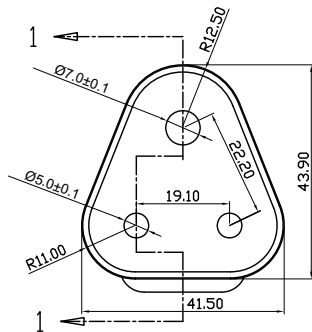
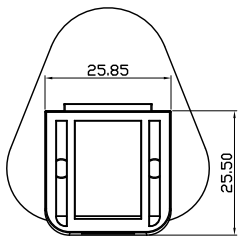

剖面 1-1

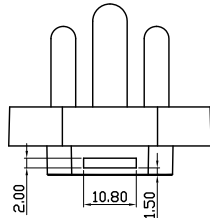

**NOTE: GROUND/EARTH PIN IS NOT ELECTRICALLY CONNECTED TO POWER SUPPLY**

Foot Note: Globtek Inc. will not be liable for the safety and performance of these power supplies if unauthorized access and repair occurs. End user should consult applicable UL, CSA or EN standards for proper installation instructions	DASH NO.	PART NO	REV.	DESCRIPTION	NOTES
	<b>TABULATION BLOCK</b>				
			TOLERANCES: DECIMALS .xx +/- 0.1 .xxx +/- .005 MILLIMETERS .xx +/- 0.3 .xxx +/- .013		 <b>186 Veterans Dr. Northvale, NJ 07647</b> <b>Tel. 201-784-1000 Fax 201.784.0111</b> <b>www.globtek.com</b>
	INIT.BY: CH	DATE: 07/27/09	FSCN No.: G, N	SIZE A	
Limitation of Use: Globtek product are not authorized for use as mission critical components in life support, hazardous environment, nuclear or aircraft applications without prior written approval from the CEO of Globtek Inc.	DRAWN: NF	DATE: 07/27/09	SCALE: NONE	MODEL NO: N/A	REV. F
	APRVD : HM	DATE: 07/27/09		PART NO: Q-IN(R)	SHEET 1 OF 2

**PROPRIETARY INFORMATION:**  
 PROPRIETARY OF GLOBTEK, INC. ANY REPRODUCTION, DISCLOSURE OR  
 USE OF THIS DRAWING, IN WHOLE OR IN PART, IS HEREBY  
 PROHIBITED EXCEPT AS SPECIFIED IN WRITING BY GLOBTEK, INC.

**3. PACKING:**

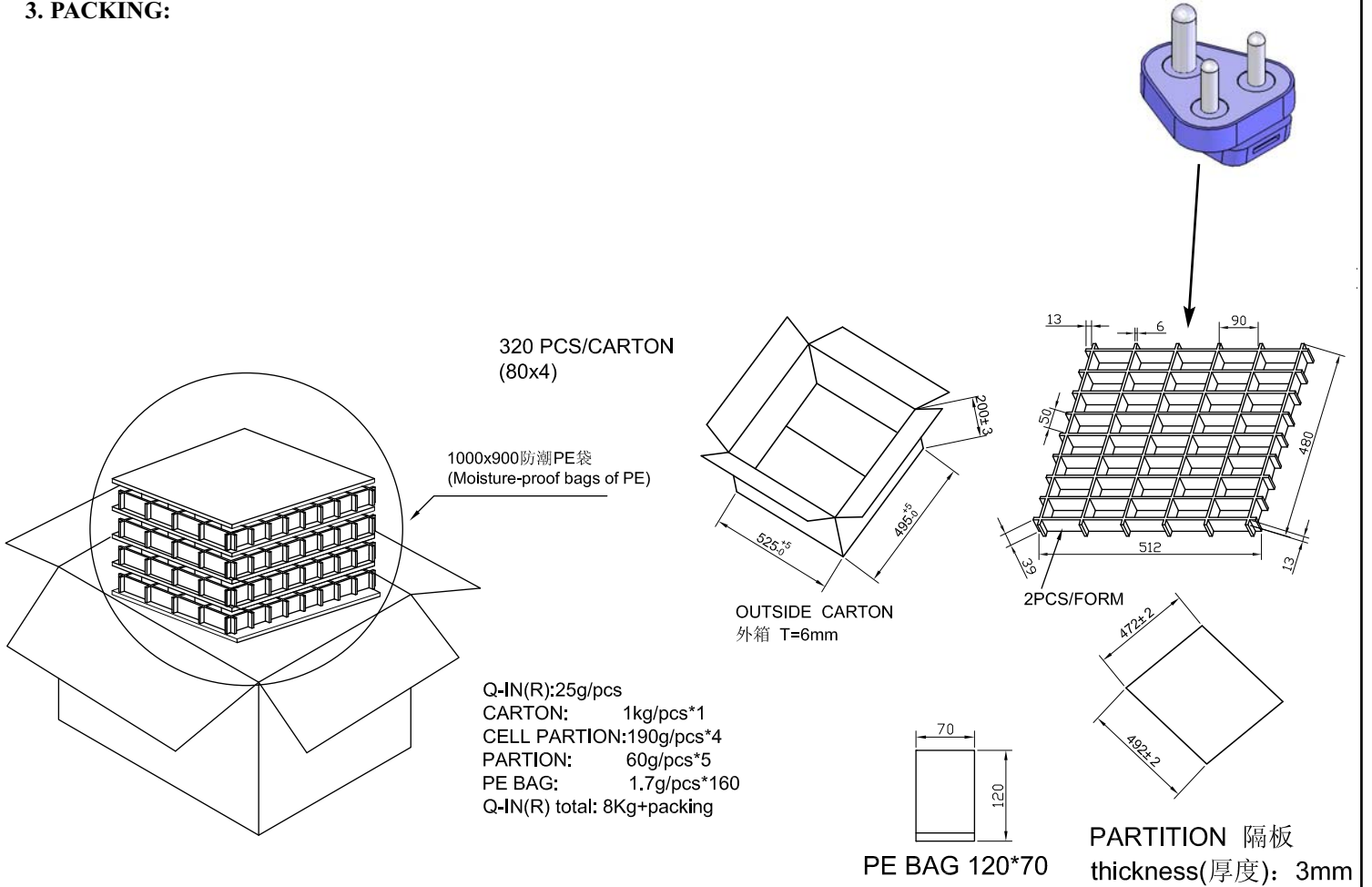

 <b>GlobTek, Inc.</b> <a href="http://www.globtek.com">www.globtek.com</a>		186 Veterans Dr. Northvale, NJ 07647 Tel. 201-784-1000 Fax 201.784.0111	
DWG TITLE: INTERCHANGEABLE PLUG FOR GT-4XXXX SERIES, INDIA/SOUTH AFRICA			
MODEL NO: N/A		REV. F	
PART NO: Q-IN(R)		SHEET 2 OF 2	