



Chipsmall Limited consists of a professional team with an average of over 10 year of expertise in the distribution of electronic components. Based in Hongkong, we have already established firm and mutual-benefit business relationships with customers from,Europe,America and south Asia,supplying obsolete and hard-to-find components to meet their specific needs.

With the principle of “Quality Parts,Customers Priority,Honest Operation,and Considerate Service”,our business mainly focus on the distribution of electronic components. Line cards we deal with include Microchip,ALPS,ROHM,Xilinx,Pulse,ON,Everlight and Freescale. Main products comprise IC,Modules,Potentiometer,IC Socket,Relay,Connector.Our parts cover such applications as commercial,industrial, and automotives areas.

We are looking forward to setting up business relationship with you and hope to provide you with the best service and solution. Let us make a better world for our industry!



Contact us

Tel: +86-755-8981 8866 Fax: +86-755-8427 6832

Email & Skype: info@chipsmall.com Web: www.chipsmall.com

Address: A1208, Overseas Decoration Building, #122 Zhenhua RD., Futian, Shenzhen, China



QT-Brightek SMD Display Series

0.40" Dual Digit SMD Display

Part No.: QBDS40ZXX

XX= Color

Z= 1: Common Cathode

Z = 0: Common Anode

Table of Contents:

Introduction	3
Electrical / Optical Characteristic: (Ta=25 °C)	4
Absolute Maximum Rating	4
Pin Configuration	5
Characteristic Curves.....	6
Solder Profile & Footprint.....	8
Packing & Labeling	9
Ordering Information	10
Revision History	11
Disclaimer	11

Introduction

Feature:

- 0.40" dual digit seven segments display
- Low power consumption
- Packed in tape & reel
- White segment and grey surface
- XX = color code
- Z=1: Common Cathode or 0: Common Anode

Description:

These 0.40" dual digit seven segments displays are made with white segment and grey surface. The viewing distance is up to seven meters.

Application:

- Instrument panels
- Indoor/Outdoor display board
- Audio equipment

Certification & Compliance:

- TS16949
- ISO9001
- RoHS Compliant

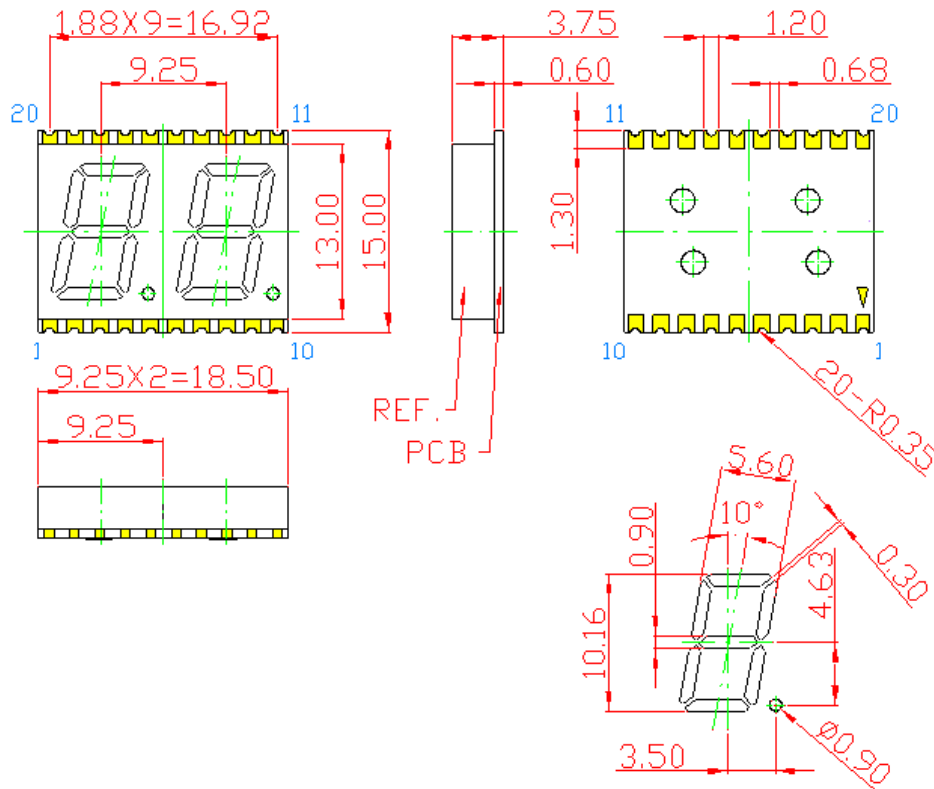
**Dimension:**

Units: mm / tolerance = +/-0.25mm

Electrical / Optical Characteristic: (Ta=25 °C)

Product		Material	Color	I _F (mA)	V _F (V)		λ _d (nm)			I _V (mcd)
CC	CA				Typ.	Max.	Min.	Typ.	Max.	Typ.
QBDS401R	QBDS400R	AllnGaP	Red	20	2.0	2.6	-	625	-	30
QBDS401S	QBDS400S	AllnGaP	Deep Red	20	2.0	2.6	-	640	-	10
QBDS401Y	QBDS400Y	AllnGaP	Yellow	20	2.0	2.6	-	590	-	20
QBDS401O	QBDS400O	AllnGaP	Orange	20	2.0	2.6	-	610	-	20
QBDS401AG	QBDS400AG	AllnGaP	Yellow Green	20	2.1	2.6	-	571	-	8
QBDS401IG	QBDS400IG	InGaN	True Green	20	2.8	3.8	-	520	-	180
QBDS401IB	QBDS400IB	InGaN	Blue	20	3.1	4.0	-	470	-	60

Absolute Maximum Rating

Material	P _d (mW)	Derating linear from 25C per dice (mA/C)	I _F (mA)	I _{FP} (mA)*	V _R (V)	T _{OP} (°C)	T _{ST} (°C)	T _{SOL} (°C)**
AllnGaP	70	0.28	25	90	5	-40 to +105	-40 to +105	260
InGaN	120	0.3	30	100	5	-40 to +105	-40 to +105	260

*Duty 1/10 @ 1KHz

**IR Reflow for no more than 5 sec @ 260 °C

Pin Configuration

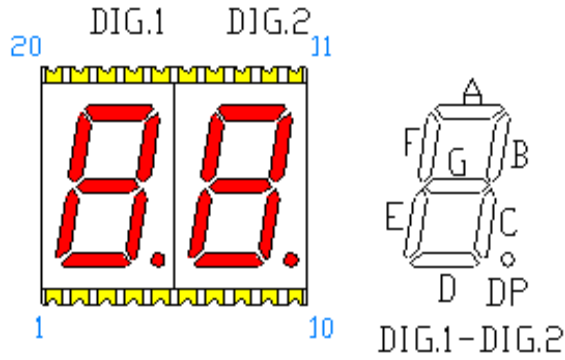

CC

CA

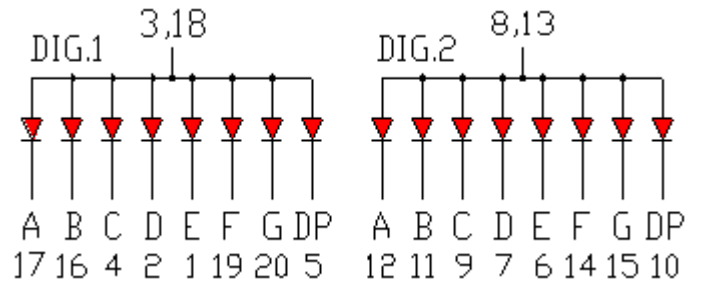
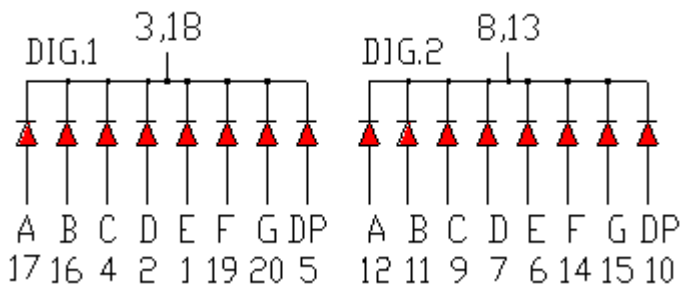

Characteristic Curves

AllnGaP

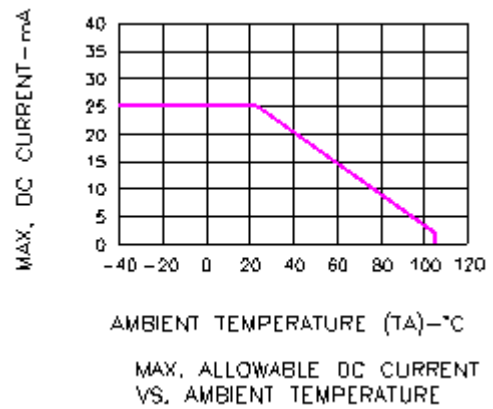
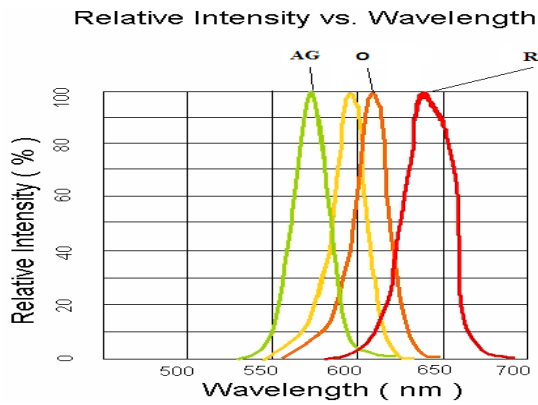
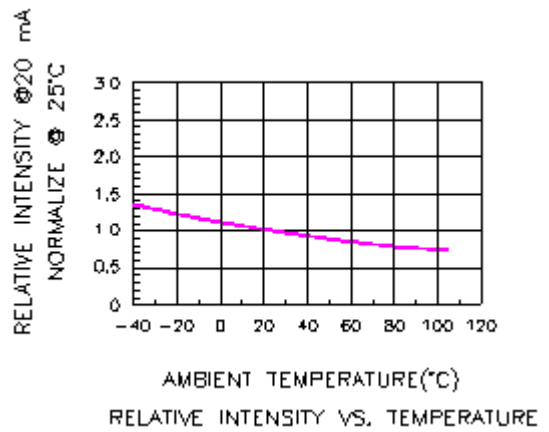
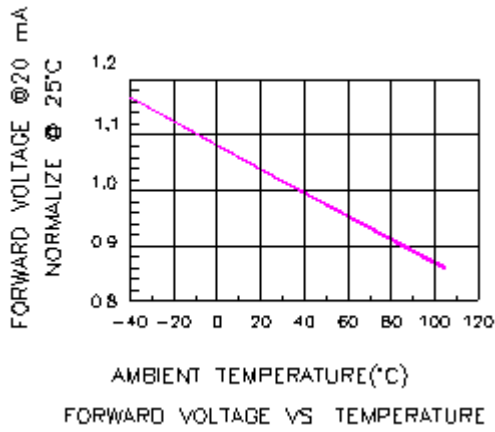
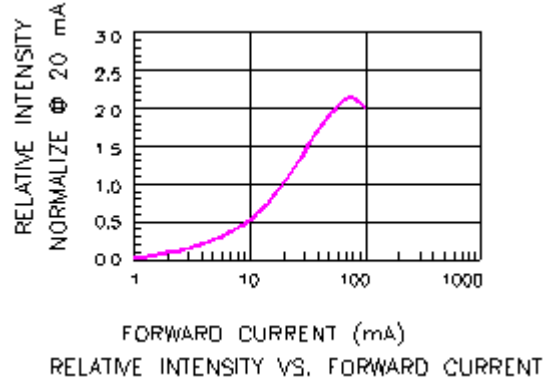
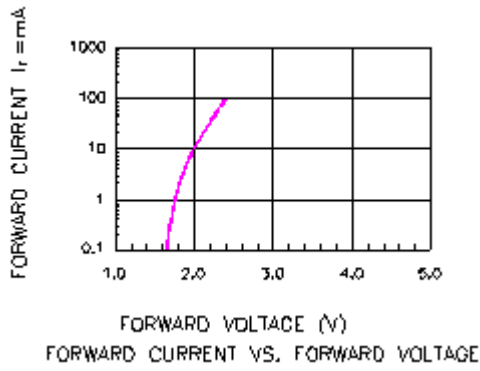

InGaN

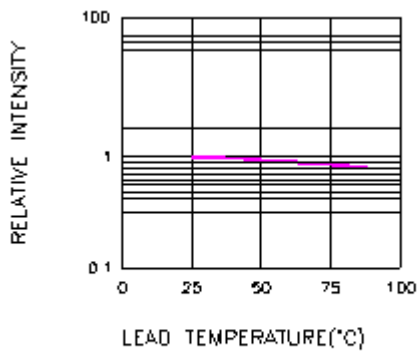
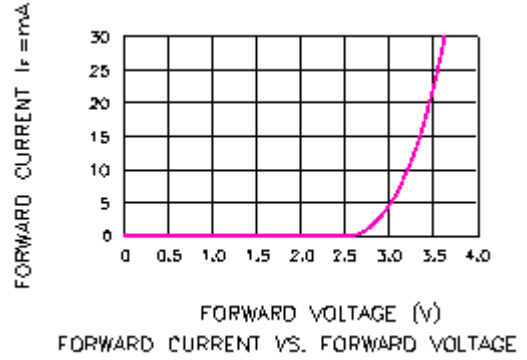
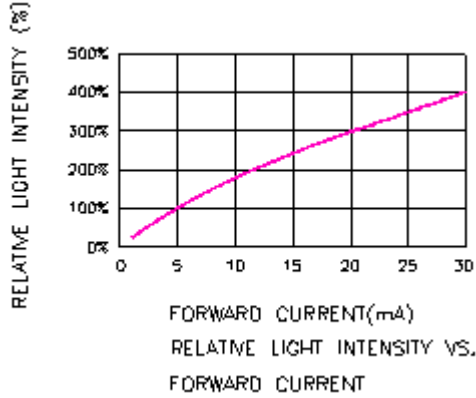

Fig.3 RELATIVE INTENSITY VS.LEAD TEMPERATURE
(PULSED 20 mA; 300us PULSE,10ms PERIOD)

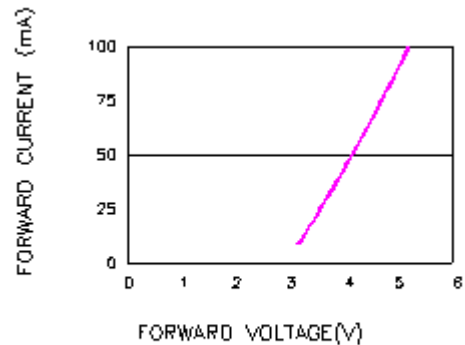

Fig.4 PEAK FORWARD VOLTAGE VS.FORWARD(100us TEST PULSE, 1% DUTY CYCLE)

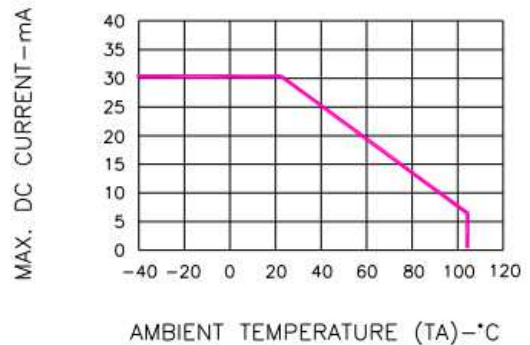
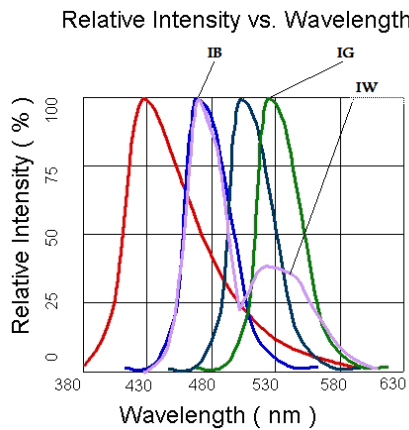
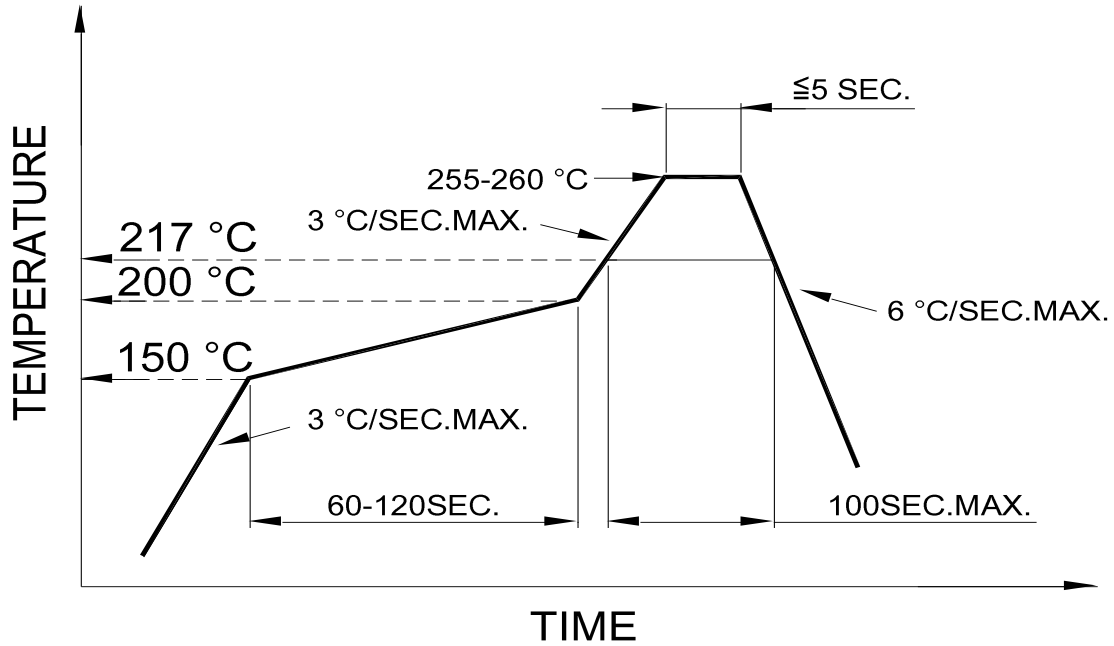

Fig.6 MAX. ALLOWABLE DC CURRENT VS. AMBIENT TEMPERATURE

Solder Profile & Footprint

Lead-free Solder Profile:

Pb free reflow soldering Profile



Recommended Pad Layout

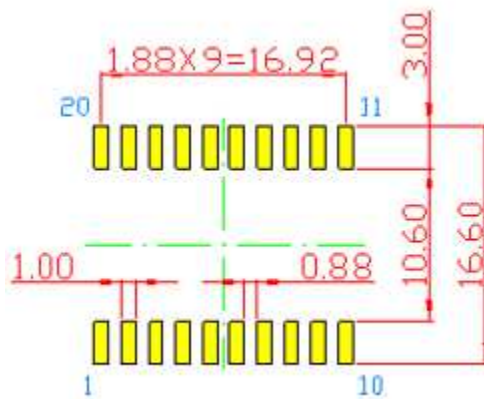

Units: mm

Tolerance: ± 0.25 mm

Packing & Labeling

Reel Dimension:

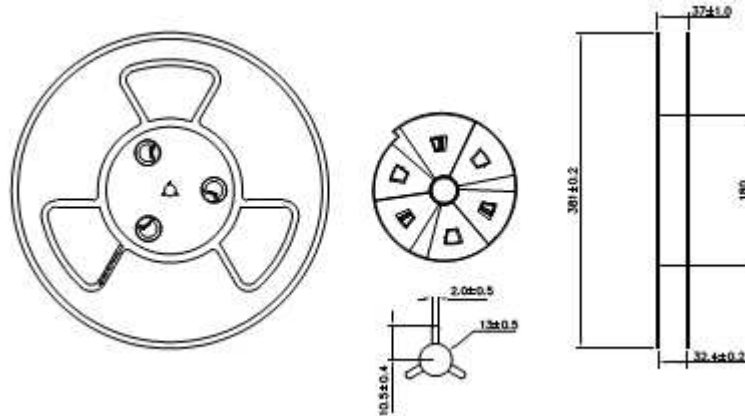

Unit: mm

Packing and Label Specification:

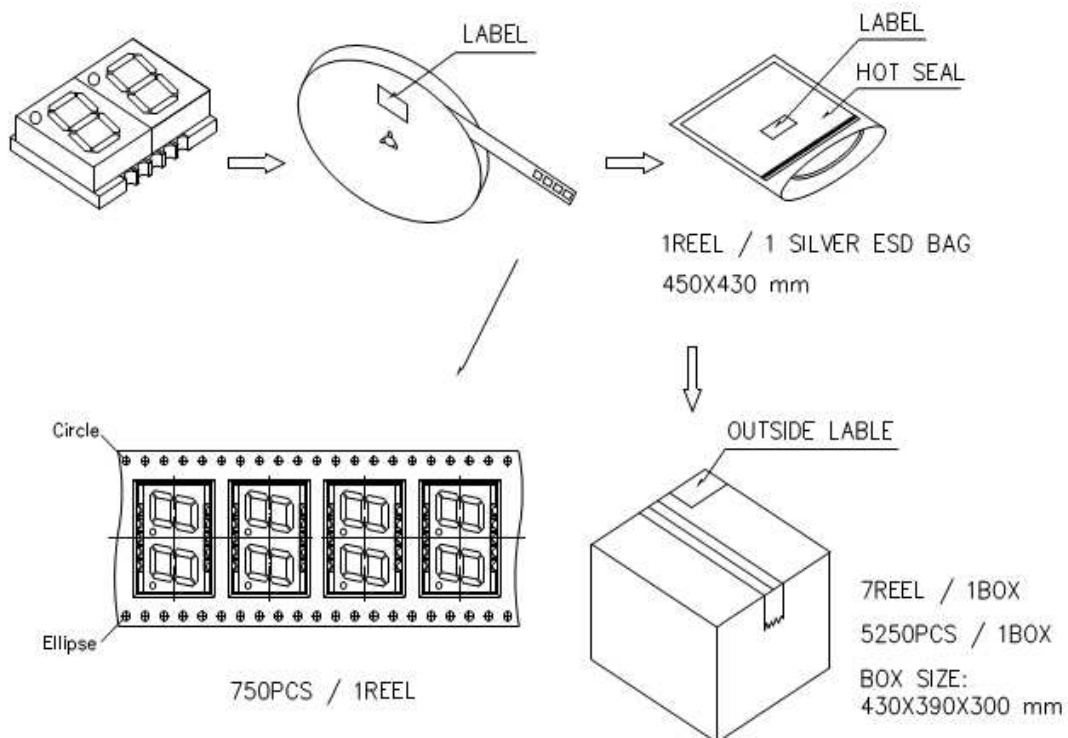

Product: QBDS40ZXX	Date: October 30, 2015	Page 9 of 11
	Version# 1.1	

Ordering Information

Product		Orderable Part #		Spec Range	Quantity per Reel
CC	CA	CC	CA		
QBDS401R	QBDS400R	QBDS401R	QBDS400R	I _v =30mcd Typ. @ I _F =20mA, λ _D : 625nm typ.	750
QBDS401S	QBDS400S	QBDS401S	QBDS400S	I _v =10mcd Typ. @ I _F =20mA, λ _D : 640nm typ.	750
QBDS401Y	QBDS400Y	QBDS401Y	QBDS400Y	I _v =20mcd Typ. @ I _F =20mA, λ _D : 590nm typ.	750
QBDS401O	QBDS400O	QBDS401O	QBDS400O	I _v =20mcd Typ. @ I _F =20mA, λ _D : 610nm typ.	750
QBDS401AG	QBDS400AG	QBDS401AG	QBDS400AG	I _v =8mcd Typ. @ I _F =20mA, λ _D : 571nm typ.	750
QBDS401IG	QBDS400IG	QBDS401IG	QBDS400IG	I _v =180mcd Typ. @ I _F =20mA, λ _D : 520nm typ.	750
QBDS401IB	QBDS400IB	QBDS401IB	QBDS400IB	I _v =60mcd Typ. @ I _F =20mA, λ _D : 470nm typ.	750

Revision History

Description:	Revision #	Revision Date
New Release of QBDS40ZXX	V1.0	03/25/2014
Add more colors, update drawing dimension	V1.1	10/30/2015

Disclaimer

QT-BRIGHTEK reserves the right to make changes without further notice to any products herein to improve reliability, function or design. QT-BRIGHTEK does not assume any liability arising out of the application or use of any product or circuit described herein; neither does it convey any license under its patent rights, nor the rights of others.

Life Support Policy

QT-BRIGHTEK's products are not authorized for use as critical components in life support devices or systems without the express written approval of QT-BRIGHTEK. As used herein:

1. Life support devices or systems are devices or systems which, (a) are intended for surgical implant into the body, or (b) support or sustain life, and (c) whose failure to perform when properly used in accordance with instructions for use provided in the labeling, can be reasonably expected to result in a significant injury of the user.
2. A critical component in any component of a life support device or system whose failure to perform can be reasonably expected to cause the failure of the life support device or system, or to affect its safety or effectiveness.