



Chipsmall Limited consists of a professional team with an average of over 10 year of expertise in the distribution of electronic components. Based in Hongkong, we have already established firm and mutual-benefit business relationships with customers from,Europe,America and south Asia,supplying obsolete and hard-to-find components to meet their specific needs.

With the principle of “Quality Parts,Customers Priority,Honest Operation,and Considerate Service”,our business mainly focus on the distribution of electronic components. Line cards we deal with include Microchip,ALPS,ROHM,Xilinx,Pulse,ON,Everlight and Freescale. Main products comprise IC,Modules,Potentiometer,IC Socket,Relay,Connector.Our parts cover such applications as commercial,industrial, and automotives areas.

We are looking forward to setting up business relationship with you and hope to provide you with the best service and solution. Let us make a better world for our industry!



Contact us

Tel: +86-755-8981 8866 Fax: +86-755-8427 6832

Email & Skype: info@chipsmall.com Web: www.chipsmall.com

Address: A1208, Overseas Decoration Building, #122 Zhenhua RD., Futian, Shenzhen, China



QT-Brightek Lamp Series

3mm Round Lamp

Part No.: QBL7SA30C

Table of Contents:

Introduction	3
Electrical / Optical Characteristic (Ta=25 °C)	4
Absolute Maximum Rating	4
Characteristic Curves.....	5
Ordering Information	6
Revision History	7
Disclaimer	7

Introduction

Feature:

- Water clear lens
- Packed in bulk
- 3mm round lamp
- AlGaAs technology
- Viewing angle: 30° typ.

Description:

These bright 3mm round type lamps are suitable for all indicator applications such as electronic signs and electronic board indicator.

Application:

- General purpose indicator application
- Electronic signs and electronics board
- LED lighting

Certification & Compliance:

- TS16949
- ISO9001
- RoHS Compliant



Dimension:

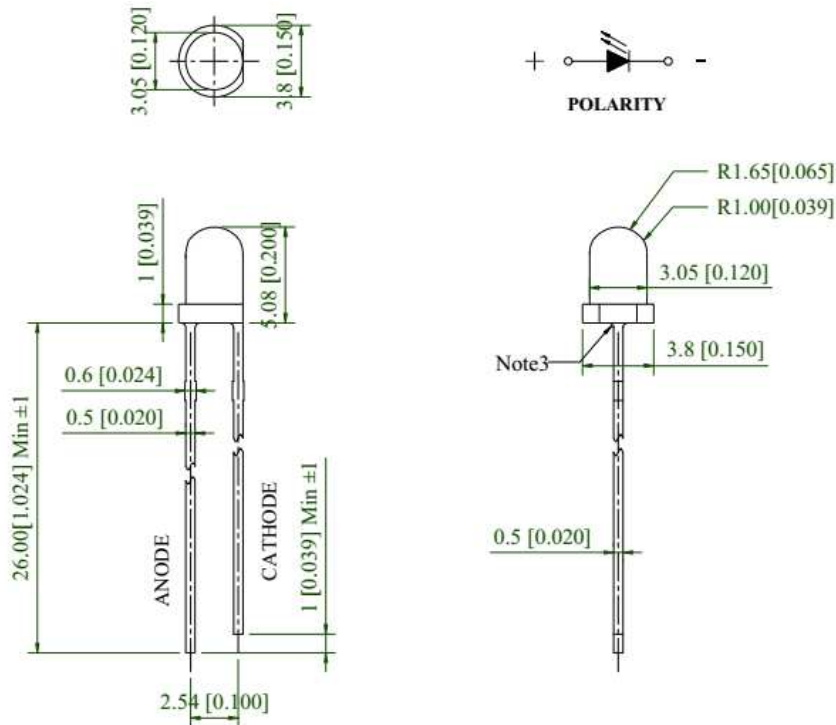

Units: mm / general tolerance = +/-0.25mm unless otherwise specified

Electrical / Optical Characteristic (Ta=25 °C)

Product	Color	I _F (mA)	V _F (V)		λ _D (nm)	I _V (mcd)	
			Typ.	Max.	Typ.	Min.	Typ.
QBL7SA30C	Deep Red	20	1.8	2.4	640	45	90

Absolute Maximum Rating

Material	P _d (mW)	I _F (mA)	I _{FP} (mA)*	V _R (V)	T _{OP} (°C)	T _{ST} (°C)	T _{SOL} (°C)**
AlGaAs	60	25	100	5	-40 to +85	-40 to +100	260

*1/10 Duty Cycle, 0.1ms Pulse Width

**Wave Soldering for no more than 3 sec @ 260 °C

Characteristic Curves

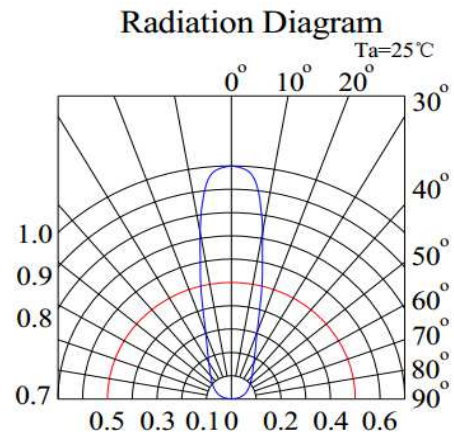
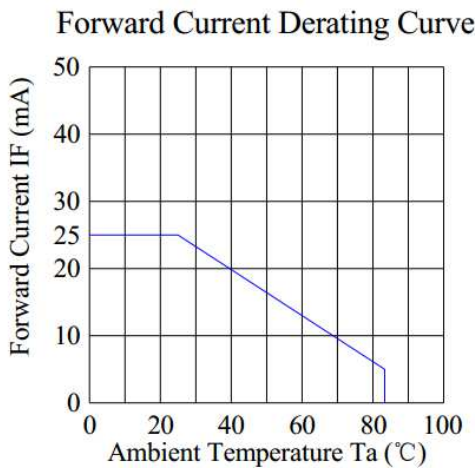
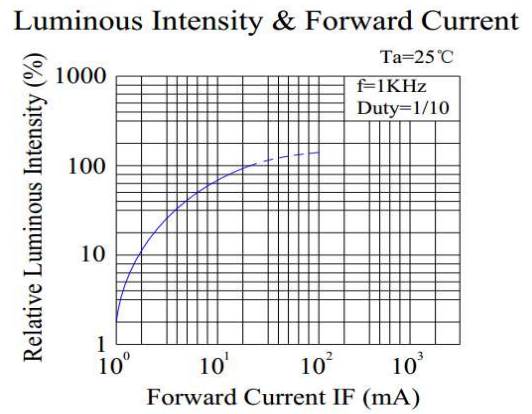
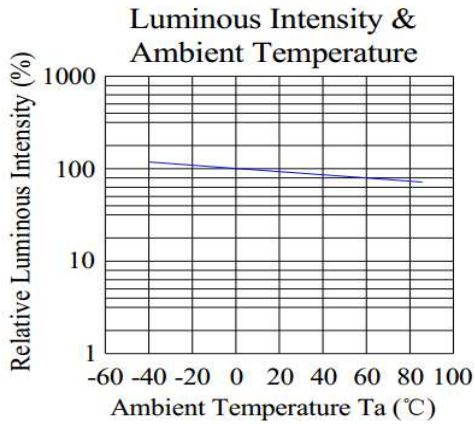
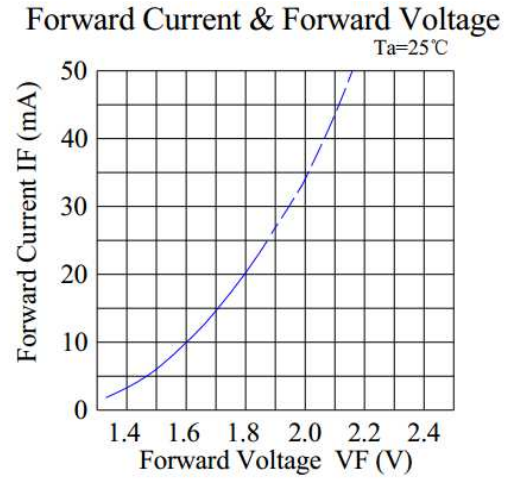
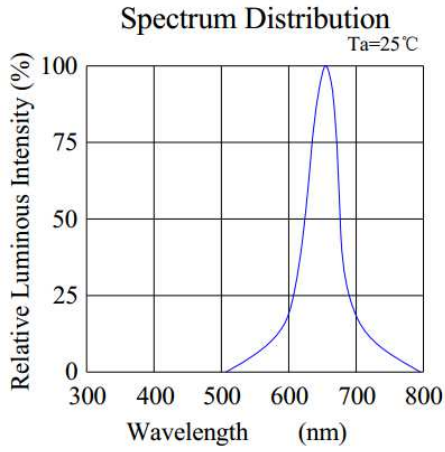

Ordering Information

Part #	Orderable Part #	Spec Range	Quantity per bag
QBL7SA30C	QBL7SA30C	Iv=90mcd typ. @ 20mA, $\lambda_D=640\text{nm}$ typ.	500pcs

Revision History

Description:	Revision #	Revision Date
New Release of QBL7SA30C	V1.0	11/22/2017

Disclaimer

QT-BRIGHTTEK reserves the right to make changes without further notice to any products herein to improve reliability, function or design. QT-BRIGHTTEK does not assume any liability arising out of the application or use of any product or circuit described herein; neither does it convey any license under its patent rights, nor the rights of others.

Life Support Policy

QT-BRIGHTTEK's products are not authorized for use as critical components in life support devices or systems without the express written approval of QT-BRIGHTTEK. As used herein:

1. Life support devices or systems are devices or systems which, (a) are intended for surgical implant into the body, or (b) support or sustain life, and (c) whose failure to perform when properly used in accordance with instructions for use provided in the labeling, can be reasonably expected to result in a significant injury of the user.
2. A critical component in any component of a life support device or system whose failure to perform can be reasonably expected to cause the failure of the life support device or system, or to affect its safety or effectiveness.