



Chipsmall Limited consists of a professional team with an average of over 10 year of expertise in the distribution of electronic components. Based in Hongkong, we have already established firm and mutual-benefit business relationships with customers from,Europe,America and south Asia,supplying obsolete and hard-to-find components to meet their specific needs.

With the principle of “Quality Parts,Customers Priority,Honest Operation,and Considerate Service”,our business mainly focus on the distribution of electronic components. Line cards we deal with include Microchip,ALPS,ROHM,Xilinx,Pulse,ON,Everlight and Freescale. Main products comprise IC,Modules,Potentiometer,IC Socket,Relay,Connector.Our parts cover such applications as commercial,industrial, and automotives areas.

We are looking forward to setting up business relationship with you and hope to provide you with the best service and solution. Let us make a better world for our industry!



Contact us

Tel: +86-755-8981 8866 Fax: +86-755-8427 6832

Email & Skype: info@chipsmall.com Web: www.chipsmall.com

Address: A1208, Overseas Decoration Building, #122 Zhenhua RD., Futian, Shenzhen, China



QT-Brightek Lamp with Housing Series

3mm Round Lamp with Housing

Part No.: QBL7XX80D-MP4B_series

Table of Contents:

Introduction	3
Electrical / Optical Characteristic (Ta=25 °C)	4
Absolute Maximum Rating	4
Characteristic Curves.....	5
Labeling	8
Ordering Information	9
Revision History	10
Disclaimer	10

Introduction

Feature:

- Color Diffused lens
- Packaged in bulk pack
- 3mm round TH lamp with housing
- GaAsP technology for OA, YA
- GaP technology for YG
- AlGaAs technology for Deep red (SA)
- Viewing angle: 80° typ.

Description:

These 3mm round type lamps with housing is easy to mount on the panels.

Application:

- General purpose indicator application
- Electronic instrument

Certification & Compliance:

- TS16949
- ISO9001
- RoHS Compliant



Dimension:

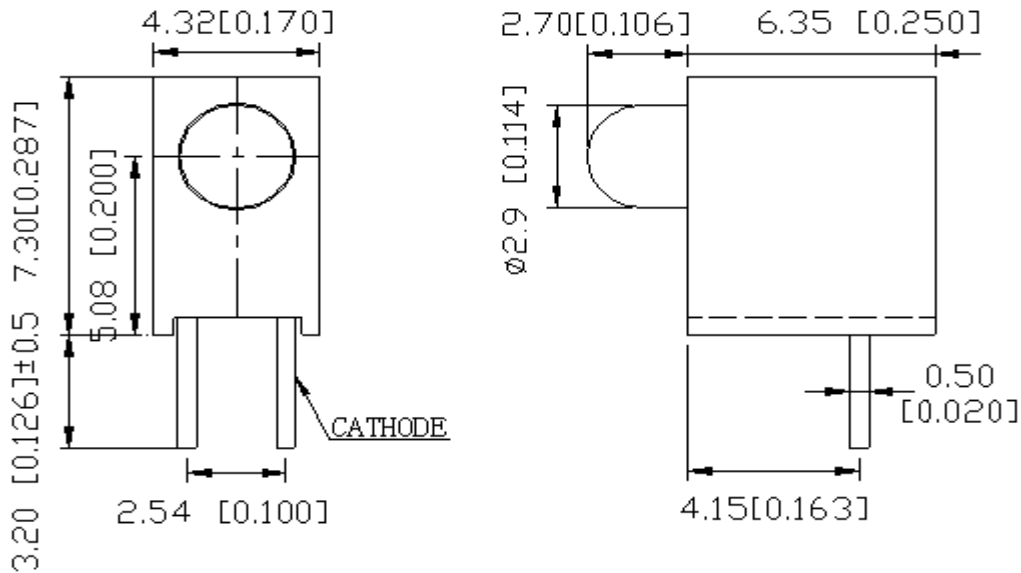

Units: mm / general tolerance = +/-0.5mm unless otherwise specified

Electrical / Optical Characteristic (Ta=25°C)

Product	Color	I _F (mA)	V _F (V)		λ _D (nm)			I _V (mcd)	
			Typ.	Max.	Min.	Typ.	Max.	Min.	Typ.
QBL7SA80D-MP4B	Deep Red	20	1.8	2.6	--	640	--	20	45
QBL7OA80D-MP4B	Orange	20	2.0	2.6	--	603	--	13	30
QBL7YA80D-MP4B	Yellow	20	2.0	2.6	--	588	--	13	20
QBL7YG80D-MP4B	GaP Green	20	2.2	2.6	--	570	--	13	30

Absolute Maximum Rating

Material	P _d (mW)	I _F (mA)	I _{FP} (mA)*	V _R (V)	T _{OP} (°C)	T _{ST} (°C)	T _{SOL} (°C)**
AlGaAs	60	25	100	5	-40 to +80	-40 to +85	260
GaAsP	78	30	100	5	-40 to +80	-40 to +85	260
GaP	78	30	100	5	-40 to +80	-40 to +85	260

*Duty=0.1, 0.1ms Pulse Width

**Wave Soldering for no more than 3 sec @ 260 °C

Note:

Tolerance of measurement of forward voltage: ±0.1V

Tolerance of measurement of luminous intensity: ±15%

Tolerance of measurement of dominant wavelength: ±2nm

Characteristic Curves

AlGaAs Deep Red

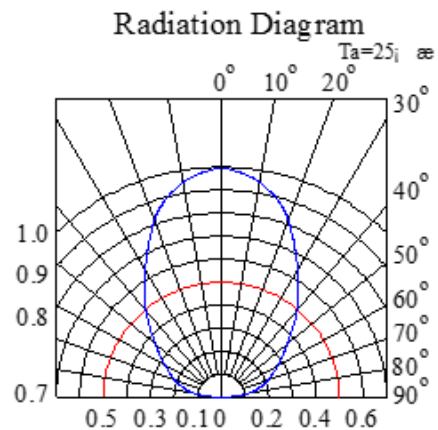
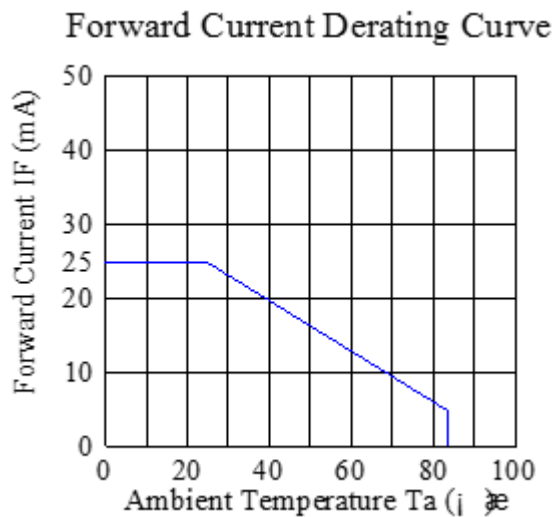
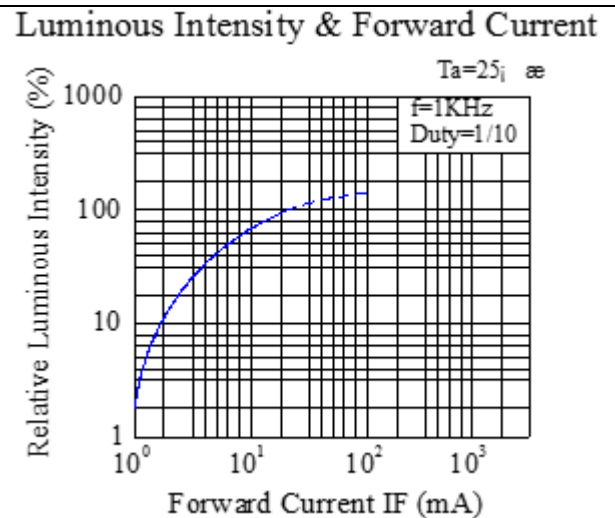
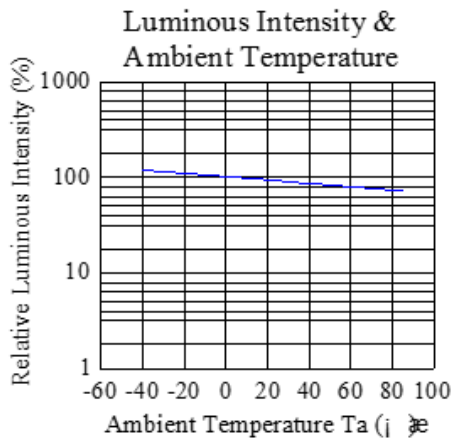
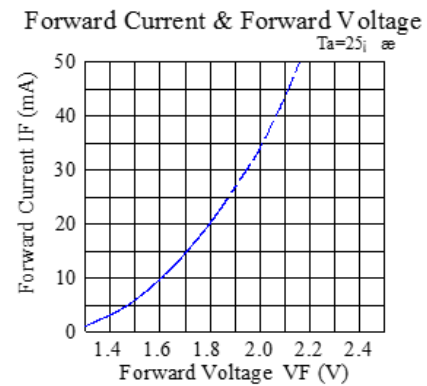
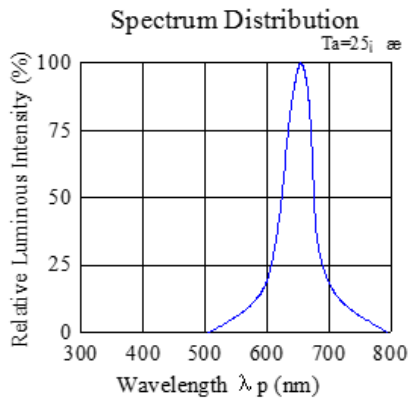

GaAsP Orange

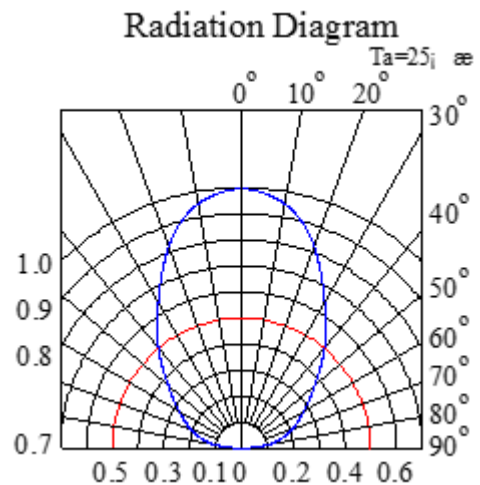
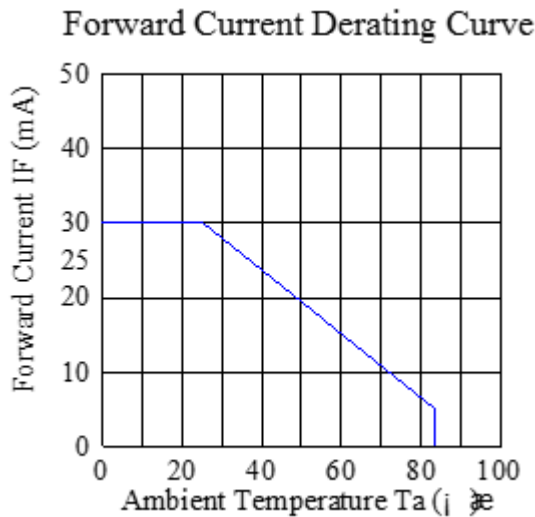
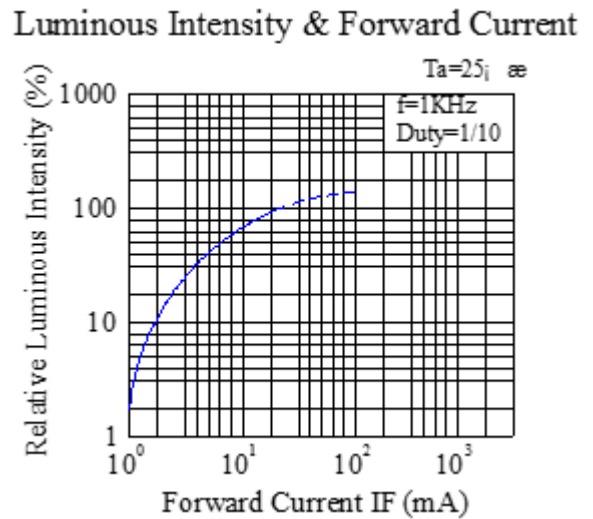
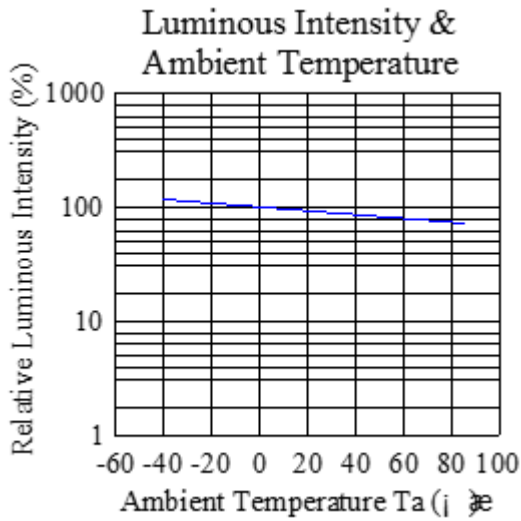
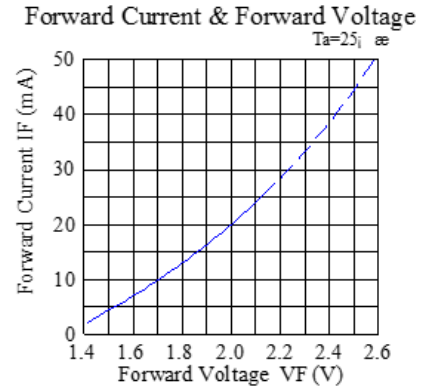
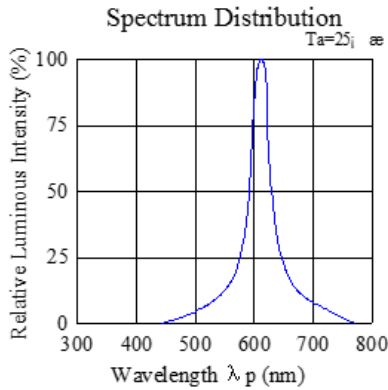

GaP Yellow-Green

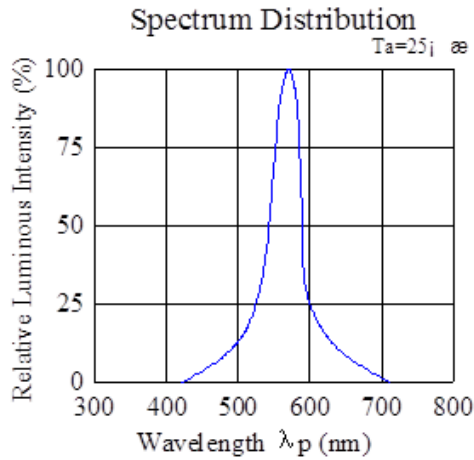

Forward Current & Forward Voltage

$T_a=25j\text{ }^{\circ}\text{C}$

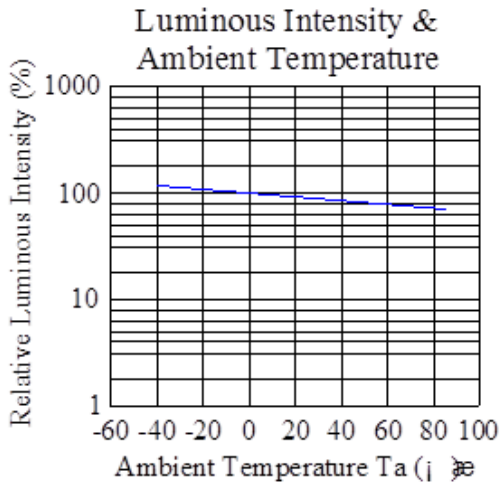
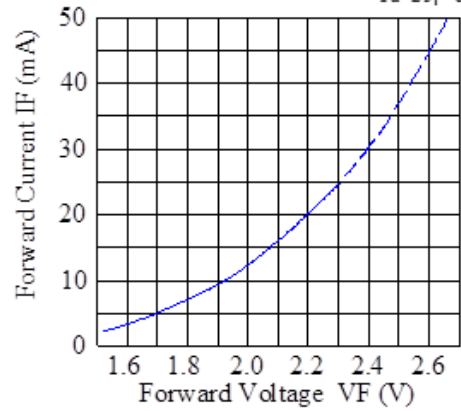

Luminous Intensity & Forward Current

$T_a=25j\text{ }^{\circ}\text{C}$

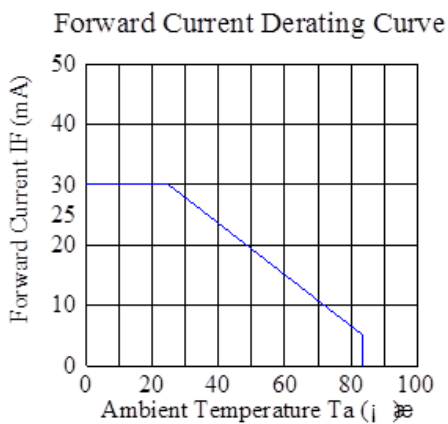
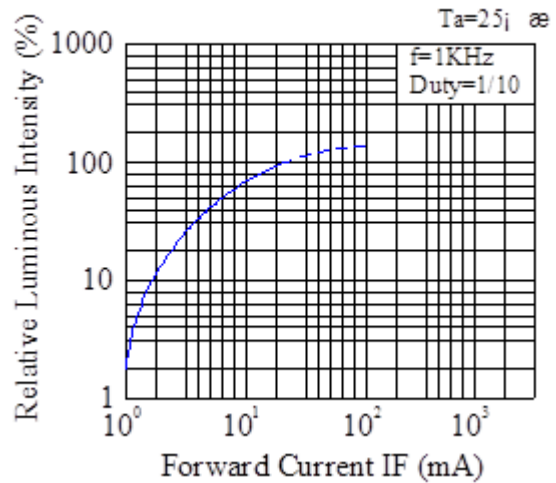

Radiation Diagram

$T_a=25j\text{ }^{\circ}\text{C}$

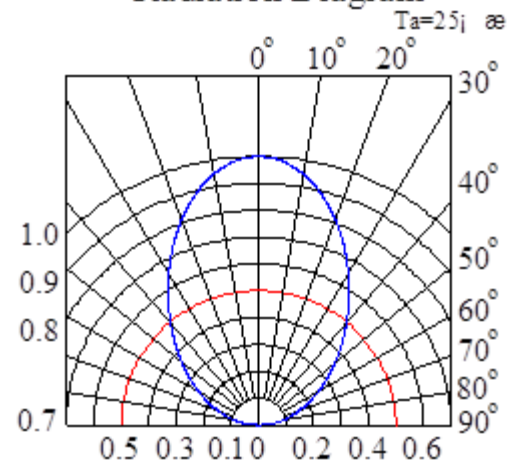

Labeling

Part No: _____
 Customer P/N: _____
 Item: _____
 Q'ty: _____
 Vf: _____
 Iv: _____
 WI: _____
 Date: _____

Made in China**Ordering Information**

Part #	Orderable Part #	Spec Range	Quantity per bag
QBL7SA80D-MP4B	QBL7SA80D-MP4B	Iv=45mcd typ. @ 20mA, λ _D =640nm typ.	500
QBL7OA80D-MP4B	QBL7OA80D-MP4B	Iv=30mcd typ. @ 20mA, λ _D =603nm typ.	500
QBL7YA80D-MP4B	QBL7YA80D-MP4B	Iv=20mcd typ. @ 20mA, λ _D =588nm typ.	500
QBL7YG80D-MP4B	QBL7YG80D-MP4B	Iv=30mcd typ. @ 20mA, λ _D =570nm typ.	500

Revision History

Description:	Revision #	Revision Date
New Release of QBL7XX80D-MP4B_series	V1.0	06/16/2016

Disclaimer

QT-BRIGHTTEK reserves the right to make changes without further notice to any products herein to improve reliability, function or design. QT-BRIGHTTEK does not assume any liability arising out of the application or use of any product or circuit described herein; neither does it convey any license under its patent rights, nor the rights of others.

Life Support Policy

QT-BRIGHTTEK's products are not authorized for use as critical components in life support devices or systems without the express written approval of QT-BRIGHTTEK. As used herein:

1. Life support devices or systems are devices or systems which, (a) are intended for surgical implant into the body, or (b) support or sustain life, and (c) whose failure to perform when properly used in accordance with instructions for use provided in the labeling, can be reasonably expected to result in a significant injury of the user.
2. A critical component in any component of a life support device or system whose failure to perform can be reasonably expected to cause the failure of the life support device or system, or to affect its safety or effectiveness.