



Chipsmall Limited consists of a professional team with an average of over 10 year of expertise in the distribution of electronic components. Based in Hongkong, we have already established firm and mutual-benefit business relationships with customers from,Europe,America and south Asia,supplying obsolete and hard-to-find components to meet their specific needs.

With the principle of "Quality Parts,Customers Priority,Honest Operation,and Considerate Service",our business mainly focus on the distribution of electronic components. Line cards we deal with include Microchip,ALPS,ROHM,Xilinx,Pulse,ON,Everlight and Freescale. Main products comprise IC,Modules,Potentiometer,IC Socket,Relay,Connector.Our parts cover such applications as commercial,industrial, and automotives areas.

We are looking forward to setting up business relationship with you and hope to provide you with the best service and solution. Let us make a better world for our industry!



Contact us

Tel: +86-755-8981 8866 Fax: +86-755-8427 6832

Email & Skype: info@chipsmall.com Web: www.chipsmall.com

Address: A1208, Overseas Decoration Building, #122 Zhenhua RD., Futian, Shenzhen, China



QT-Brightek Lamp Series

5mm Round Lamp

Part No.: QBL8XX60D

XX: Color Code

Table of Contents:

Introduction	3
Electrical / Optical Characteristic (Ta=25 °C)	4
Absolute Maximum Rating	4
Characteristic Curves.....	5
Ordering Information	7
Revision History	8
Disclaimer	8

Introduction

Feature:

- Color diffused lens
- Packaged in bulk pack
- 5mm round lamp
- Viewing angle: 60° typ.

Description:

These bright 5mm round type lamps are suitable for all indicator applications such as electronic signs and electronic board indicator.

Application:

- General purpose indicator application
- Electronic signs and electronics board
- LED lighting

Certification & Compliance:

- TS16949
- ISO9001
- RoHS Compliant



Dimension:

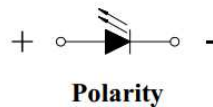
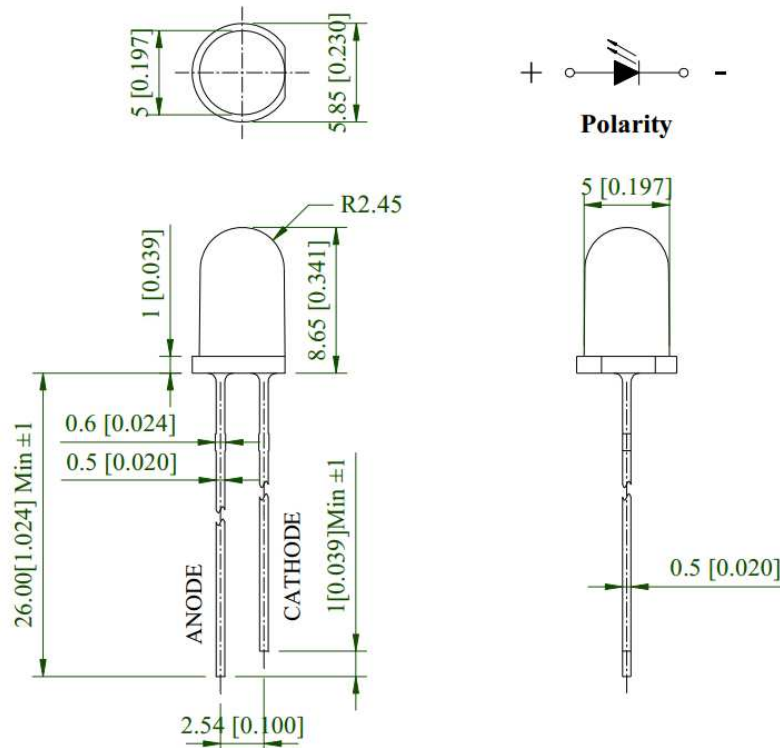

Units: mm / general tolerance = +/-0.25mm unless otherwise specified

Electrical / Optical Characteristic (Ta=25°C)

Product	Color	I _F (mA)	V _F (V)		λ _D (nm)	I _V (mcd)	
			Typ.	Max.	Typ.	Min.	Typ.
QBL8R60D	Red	20	2.0	2.6	624	210	350
QBL8S60D	Deep Red	20	2.0	2.6	630	90	160
QBL8O60D	Orange	20	2.0	2.6	605	70	120
QBL8Y60D	Yellow	20	2.0	2.6	590	160	210
QBL8AG60D	Yellow Green	20	2.0	2.6	573	45	70
QBL8IG60D	True Green	20	3.2	3.6	525	1000	1700
QBL8IB60D	Blue	20	3.2	3.6	470	350	600

Absolute Maximum Rating

Material	P _d (mW)	I _F (mA)	I _{FP} (mA)*	V _R (V)	T _{OP} (°C)	T _{ST} (°C)	T _{SOL} (°C)**
AllnGaP	65	25	100	5	-40 to +85	-40 to +100	260
InGaN	95	25	100	5	-40 to +85	-40 to +100	260

*1/10 Duty Cycle, 0.1ms Pulse Width

**Wave Soldering for no more than 3 sec @ 260 °C

Characteristic Curves

AllnGaP (R/S/AG/O/Y)

Forward Current & Forward Voltage $T_a=25^\circ\text{C}$

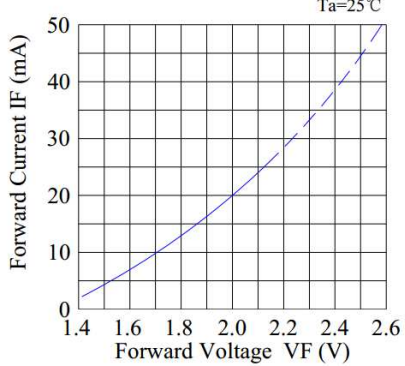

Luminous Intensity & Ambient Temperature

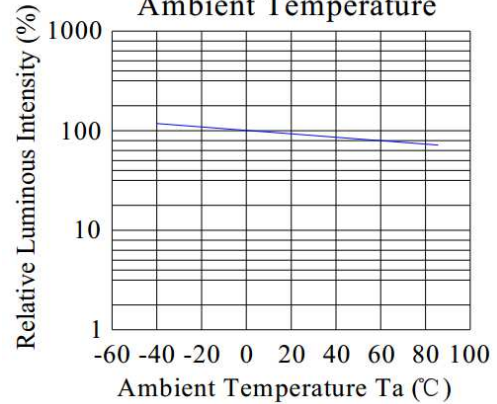

Forward Current Derating Curve

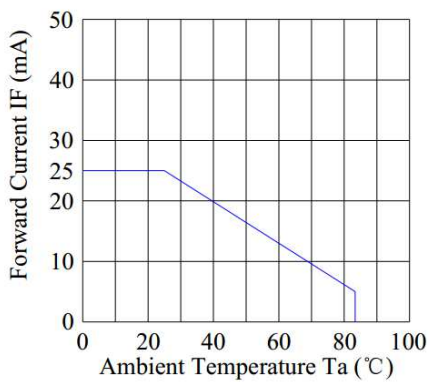

Luminous Intensity & Forward Current $T_a=25^\circ\text{C}$

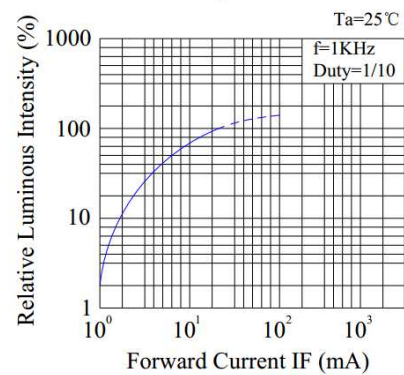

Radiation Diagram $T_a=25^\circ\text{C}$

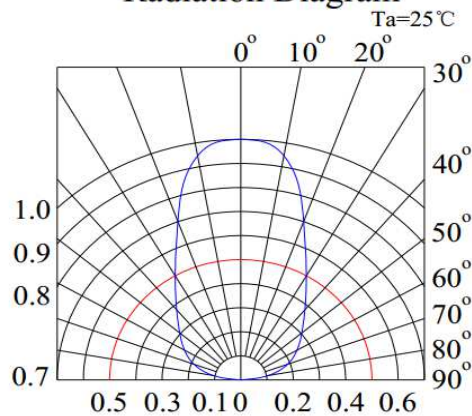

InGaN (IG/IB)

Forward Current & Forward Voltage

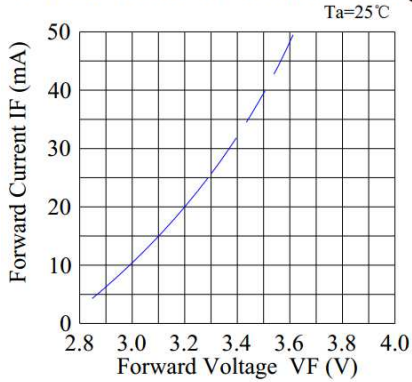

Luminous Intensity & Forward Current

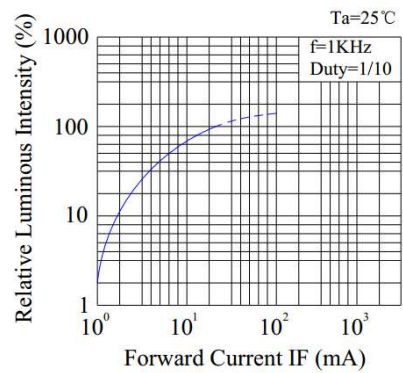

Forward Current Derating Curve

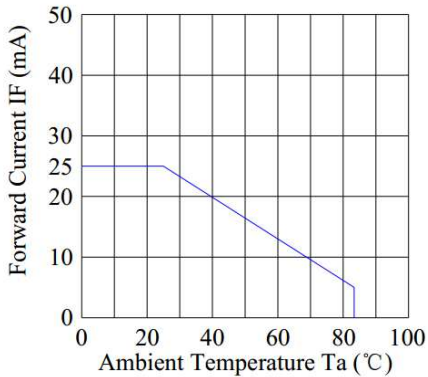

Luminous Intensity & Forward Current

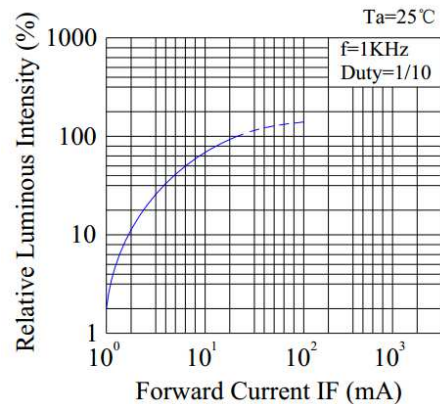

Luminous Intensity & Ambient Temperature

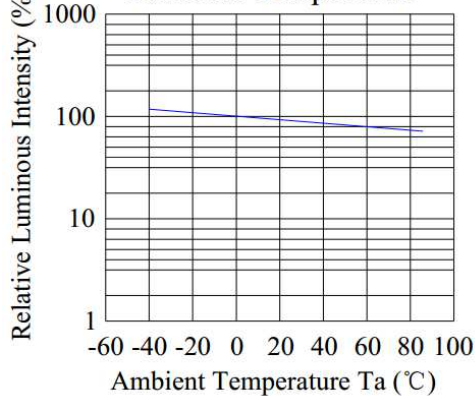

Radiation Diagram

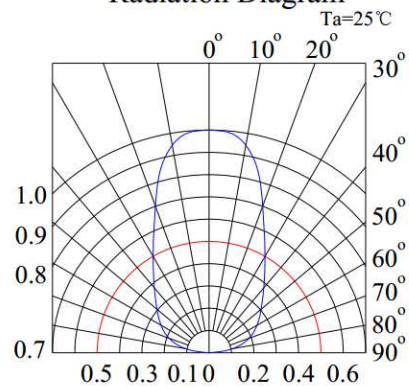

Ordering Information

Part #	Orderable Part #	Spec Range	Quantity per bag
QBL8R60D	QBL8R60D	Iv=350mcd typ. @ 20mA, $\lambda_D=624\text{nm}$ typ.	500pcs
QBL8S60D	QBL8S60D	Iv=160mcd typ. @ 20mA, $\lambda_D=630\text{nm}$ typ.	500pcs
QBL8O60D	QBL8O60D	Iv=120mcd typ. @ 20mA, $\lambda_D=605\text{nm}$ typ.	500pcs
QBL8Y60D	QBL8Y60D	Iv=210mcd typ. @ 20mA, $\lambda_D=590\text{nm}$ typ.	500pcs
QBL8AG60D	QBL8AG60D	Iv=70mcd typ. @ 20mA, $\lambda_D=573\text{nm}$ typ.	500pcs
QBL8IG60D	QBL8IG60D	Iv=1700mcd typ. @ 20mA, $\lambda_D=525\text{nm}$ typ.	500pcs
QBL8IB60D	QBL8IB60D	Iv=600mcd typ. @ 20mA, $\lambda_D=470\text{nm}$ typ.	500pcs

Revision History

Description:	Revision #	Revision Date
New Release of QBL8XX60D	V1.0	11/16/2017

Disclaimer

QT-BRIGHTTEK reserves the right to make changes without further notice to any products herein to improve reliability, function or design. QT-BRIGHTTEK does not assume any liability arising out of the application or use of any product or circuit described herein; neither does it convey any license under its patent rights, nor the rights of others.

Life Support Policy

QT-BRIGHTTEK's products are not authorized for use as critical components in life support devices or systems without the express written approval of QT-BRIGHTTEK. As used herein:

1. Life support devices or systems are devices or systems which, (a) are intended for surgical implant into the body, or (b) support or sustain life, and (c) whose failure to perform when properly used in accordance with instructions for use provided in the labeling, can be reasonably expected to result in a significant injury of the user.
2. A critical component in any component of a life support device or system whose failure to perform can be reasonably expected to cause the failure of the life support device or system, or to affect its safety or effectiveness.