



Chipsmall Limited consists of a professional team with an average of over 10 year of expertise in the distribution of electronic components. Based in Hongkong, we have already established firm and mutual-benefit business relationships with customers from,Europe,America and south Asia,supplying obsolete and hard-to-find components to meet their specific needs.

With the principle of “Quality Parts,Customers Priority,Honest Operation,and Considerate Service”,our business mainly focus on the distribution of electronic components. Line cards we deal with include Microchip,ALPS,ROHM,Xilinx,Pulse,ON,Everlight and Freescale. Main products comprise IC,Modules,Potentiometer,IC Socket,Relay,Connector.Our parts cover such applications as commercial,industrial, and automotives areas.

We are looking forward to setting up business relationship with you and hope to provide you with the best service and solution. Let us make a better world for our industry!



Contact us

Tel: +86-755-8981 8866 Fax: +86-755-8427 6832

Email & Skype: info@chipsmall.com Web: www.chipsmall.com

Address: A1208, Overseas Decoration Building, #122 Zhenhua RD., Futian, Shenzhen, China



QT-Brightek Lamp Series
5mm Round Deep Red LED
Part No.: QBL8SA15C

Table of Contents:

Introduction	3
Electrical / Optical Characteristic (Ta=25 °C)	4
Absolute Maximum Rating	4
Characteristic Curves.....	5
Ordering Information	6
Revision History	7
Disclaimer	7

Introduction

Feature:

- Clear lens
- Package in bulk pack
- 5mm round lamp
- AlGaAs technology
- Viewing angle: 15° typ.

Description:

These bright 5mm round type lamps are suitable for all indicator applications such as electronic signs and electronics board indicator

Application:

- General purpose indicator application
- Electronic signs and electronics board

Certification & Compliance:

- TS16949
- ISO9001
- RoHS Compliant



Dimension:

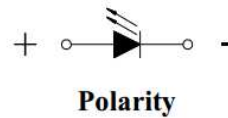
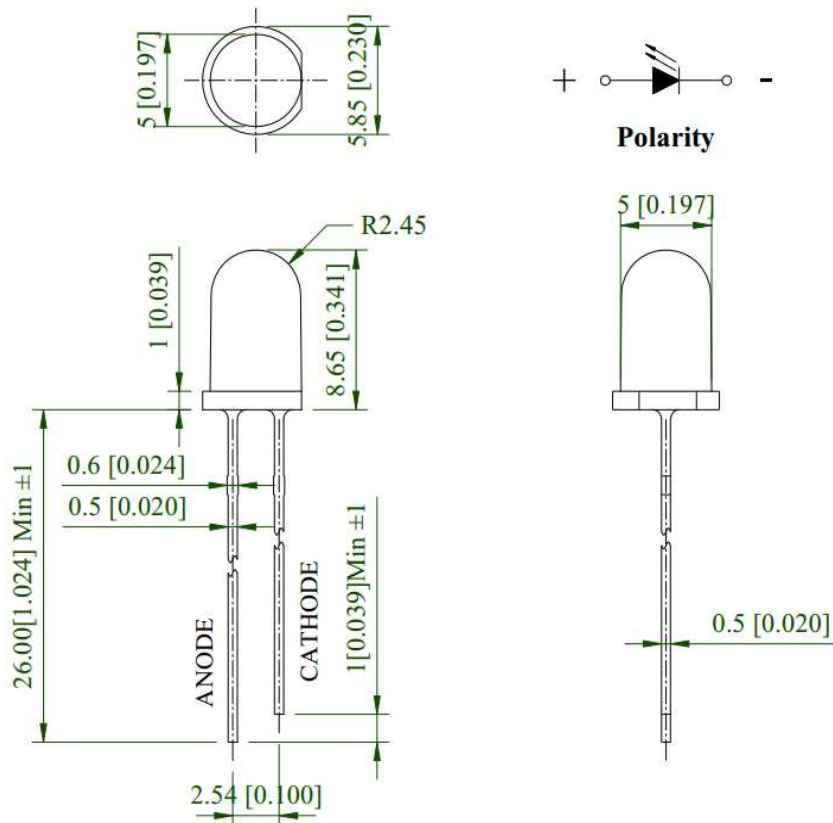

Units: mm / tolerance = +/-0.25mm unless otherwise specified

Electrical / Optical Characteristic (Ta=25°C)

Product	Color	I _F (mA)	V _F (V)		λ _D (nm)	I _V (mcd)	
			Typ.	Max.	Typ.	Min.	Typ.
QBL8SA15C	Deep Red	20	2.0	2.6	640	210	350

Absolute Maximum Rating

Material	P _d (mW)	I _F (mA)	I _{FP} (mA)*	V _R (V)	T _{OP} (°C)	T _{ST} (°C)
AlGaAs	60	25	100	5	-40 ~ +85	-40 ~ +100

*1/10 Duty Cycle, 0.1ms Pulse Width

Characteristic Curves

AlGaAs

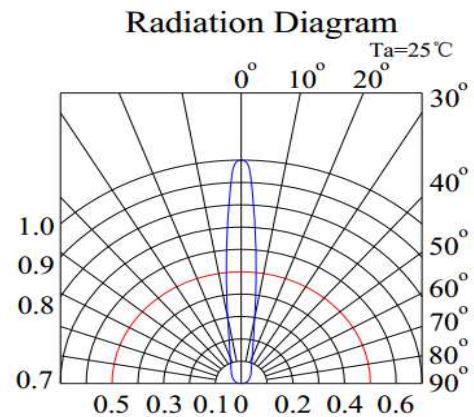
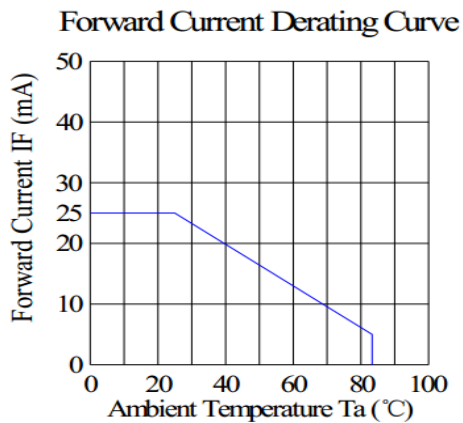
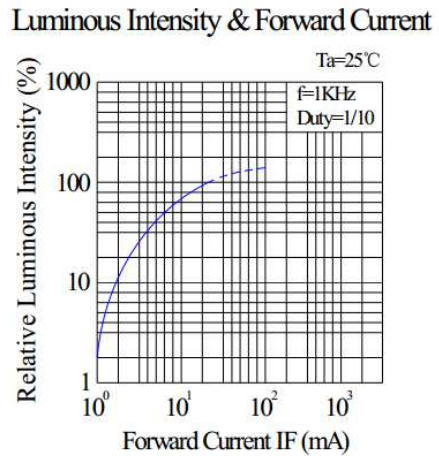
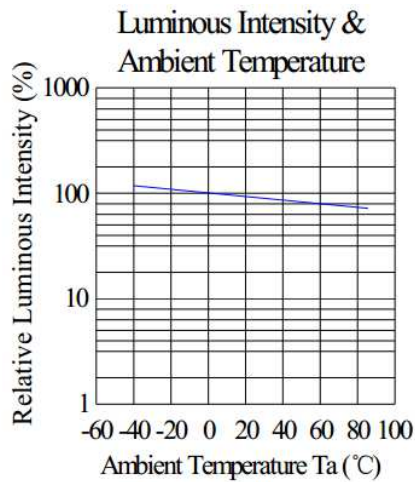
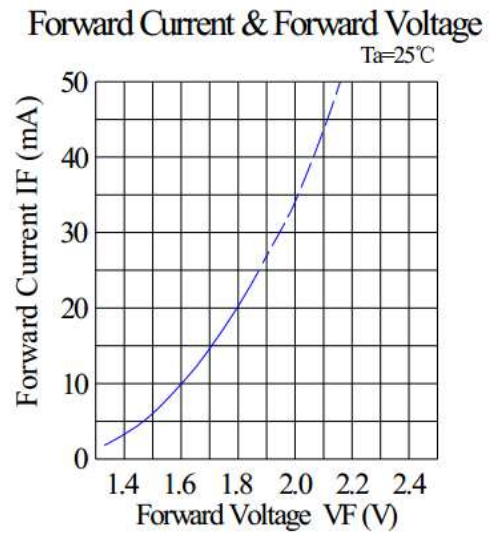
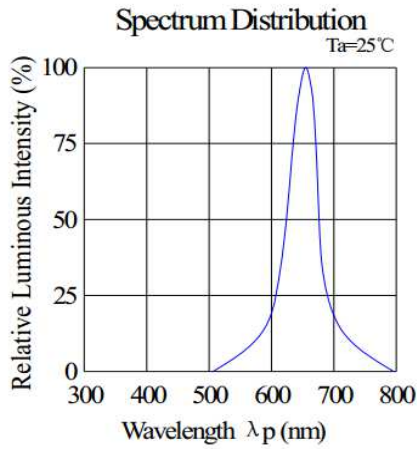



QBL8SA15C

5mm Round Lamp

Ordering Information

Part #	Orderable Part #	Spec Range	Quantity per bag
QBL8SA15C	QBL8SA15C	Iv=350mcd typ. @ 20mA, $\lambda_D=640\text{nm}$ typ.	500pcs

Revision History

Description:	Revision #	Revision Date
New Release of QBL8SA15C	V1.0	01/22/2018

Disclaimer

QT-BRIGHTTEK reserves the right to make changes without further notice to any products herein to improve reliability, function or design. QT-BRIGHTTEK does not assume any liability arising out of the application or use of any product or circuit described herein; neither does it convey any license under its patent rights, nor the rights of others.

Life Support Policy

QT-BRIGHTTEK's products are not authorized for use as critical components in life support devices or systems without the express written approval of QT-BRIGHTTEK. As used herein:

1. Life support devices or systems are devices or systems which, (a) are intended for surgical implant into the body, or (b) support or sustain life, and (c) whose failure to perform when properly used in accordance with instructions for use provided in the labeling, can be reasonably expected to result in a significant injury of the user.
2. A critical component in any component of a life support device or system whose failure to perform can be reasonably expected to cause the failure of the life support device or system, or to affect its safety or effectiveness.