



Chipsmall Limited consists of a professional team with an average of over 10 year of expertise in the distribution of electronic components. Based in Hongkong, we have already established firm and mutual-benefit business relationships with customers from,Europe,America and south Asia,supplying obsolete and hard-to-find components to meet their specific needs.

With the principle of "Quality Parts,Customers Priority,Honest Operation,and Considerate Service",our business mainly focus on the distribution of electronic components. Line cards we deal with include Microchip,ALPS,ROHM,Xilinx,Pulse,ON,Everlight and Freescale. Main products comprise IC,Modules,Potentiometer,IC Socket,Relay,Connector.Our parts cover such applications as commercial,industrial, and automotives areas.

We are looking forward to setting up business relationship with you and hope to provide you with the best service and solution. Let us make a better world for our industry!



Contact us

Tel: +86-755-8981 8866 Fax: +86-755-8427 6832

Email & Skype: info@chipsmall.com Web: www.chipsmall.com

Address: A1208, Overseas Decoration Building, #122 Zhenhua RD., Futian, Shenzhen, China



QT-Brightek Chip LED Series

0805 IR LED

Part No.: QBLP630-IR3

Table of Contents:

Introduction	3
Electrical / Optical Characteristic (Ta=25 °C)	4
Absolute Maximum Rating	4
Characteristic Curves.....	5
Solder Profile & Footprint.....	6
Packing	7
Labeling	8
Ordering Information	8
Revision History	9
Disclaimer	9

Product: QBLP630-IR3	Date: May 04, 2015	Page 2 of 9
	Version# 1.1	

Introduction

Feature:

- Water clear lens
- Package in tape and reel
- 0805 Package
- AlGaAs technology
- Viewing Angle = 140 deg

Description:

This 0805 IR LED has a height profile of 1.1mm. With a small footprint, this IR LED is ideal for smaller equipment and miniature application.

Application:

- Infrared Sensor
- Optoelectronic Switch
- Smoke detector
- Drive sensor

Certification & Compliance:

- TS16949
- ISO9001
- RoHS Compliant



Dimension:

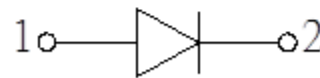
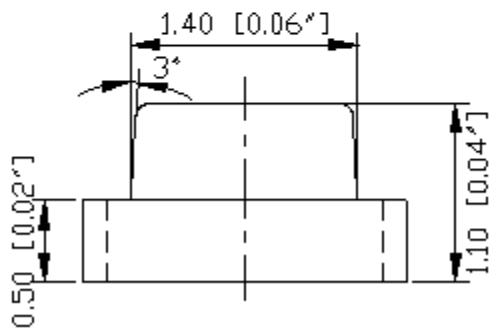
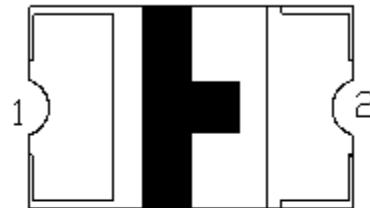
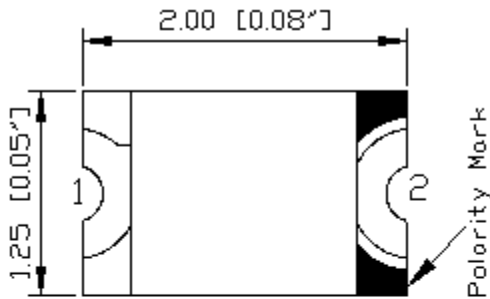

Units: mm / tolerance = +/-0.1mm

Electrical / Optical Characteristic (Ta=25 °C)

Product	Color	I _F (mA)	V _F (V)		λ _P (nm)			I _e (mW/sr)		
			Typ.	Max.	Min.	Typ.	Max.	Min.	Typ.	Max.
QBLP630-IR3	Infrared	20	1.3	1.8	-	850	-	0.1	0.6	1.6

Absolute Maximum Rating

Material	P _d (mW)	I _F (mA)	I _{FP} (A)*	V _R (V)	T _{OP} (°C)	T _{ST} (°C)	T _{SOL} (°C)**
AlGaAs	90	50	1	5	-40 ~ +80	-40 ~ +85	260

*Duty cycle=1%, Pulse width 100us

**IR Reflow for no more than 10 sec @ 260 °C

Characteristic Curves

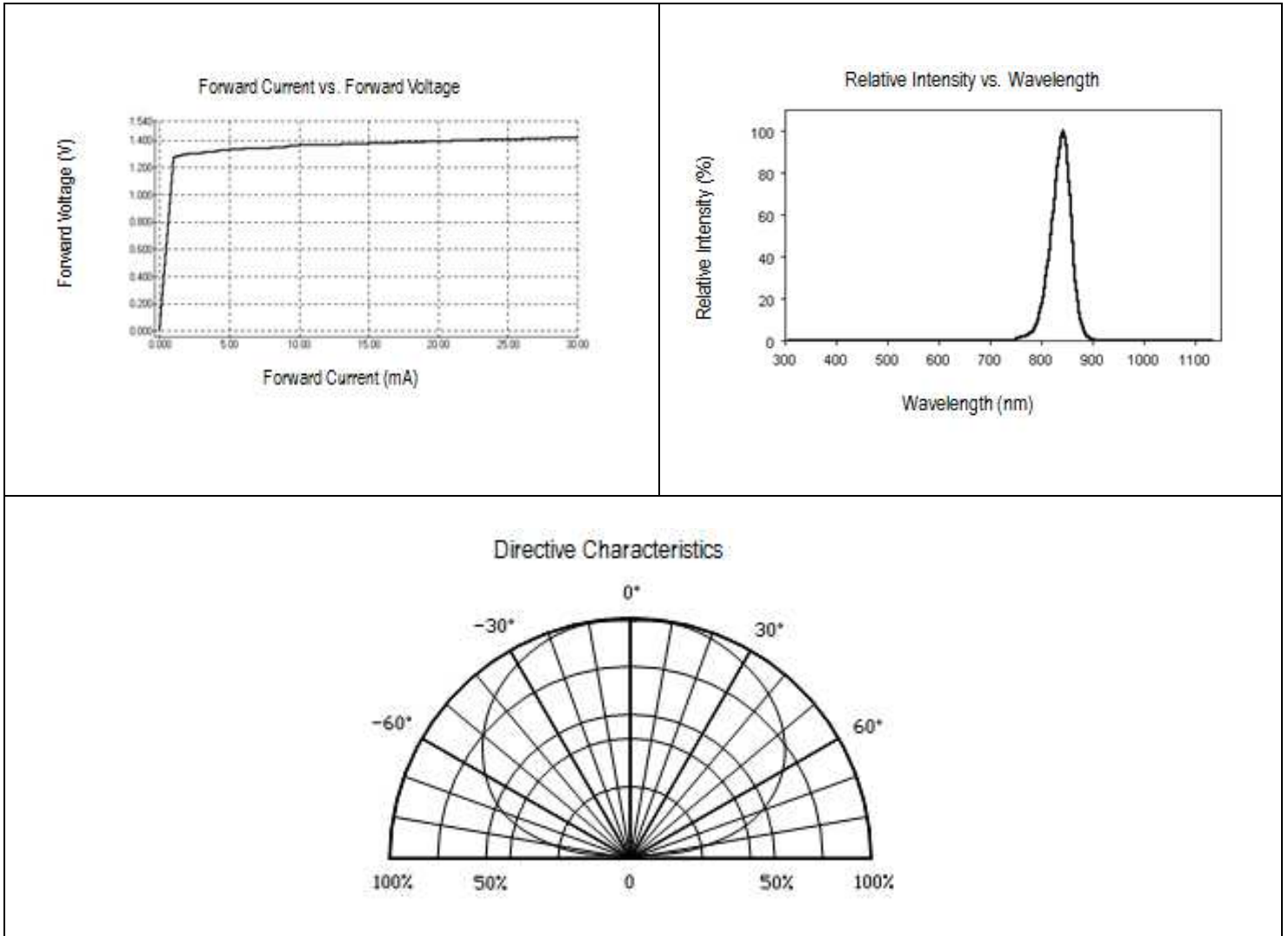

Solder Profile & Footprint

- Recommended tin solder specifications: melting temperature in the range of 178~192 °C
- The recommended reflow soldering profile is as follows (temperatures indicated are as measured on the surface of the LED resin):

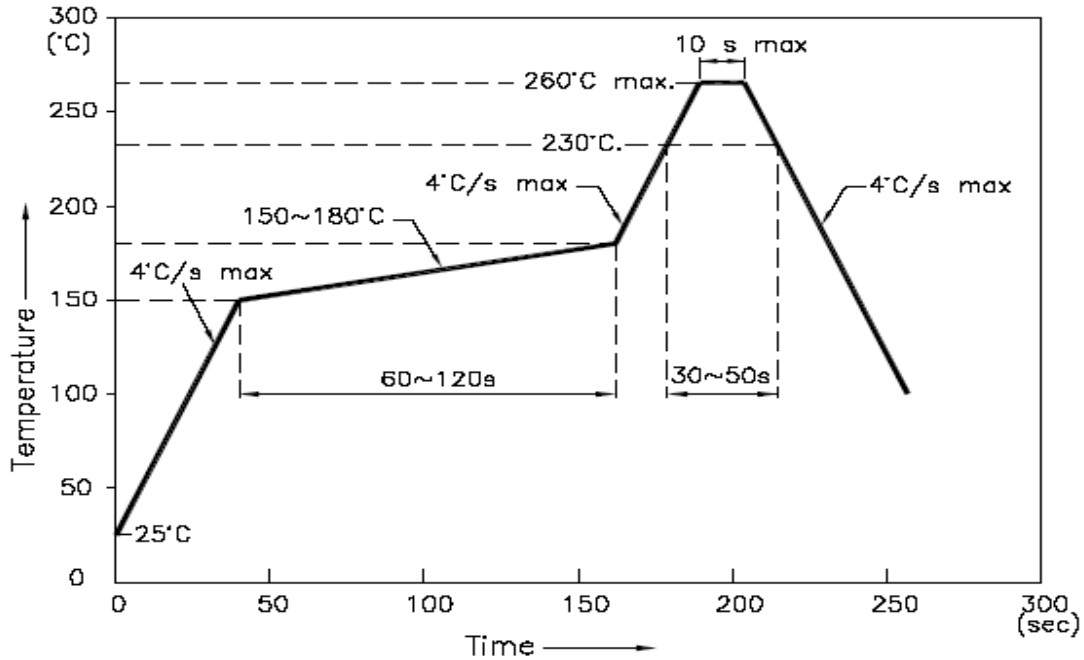

Recommended Pad Layout

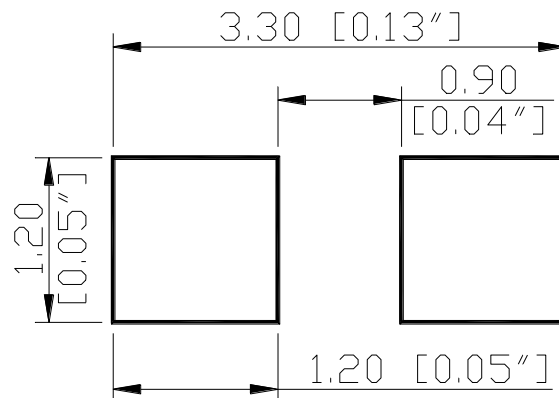

Units: mm

Tolerance: ±0.1mm

Product: QBLP630-IR3	Date: May 04, 2015	Page 6 of 9
	Version# 1.1	

Packing

Reel Dimension:

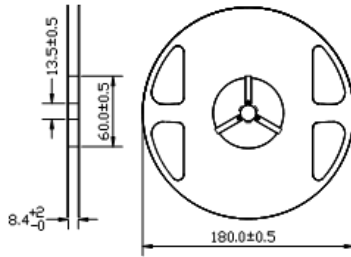

Unit: mm

Tape Dimension:

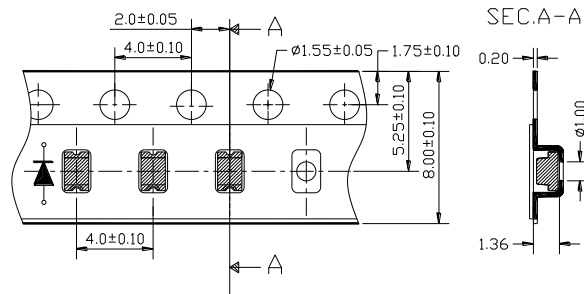

Unit: mm

Arrangement of Tape:

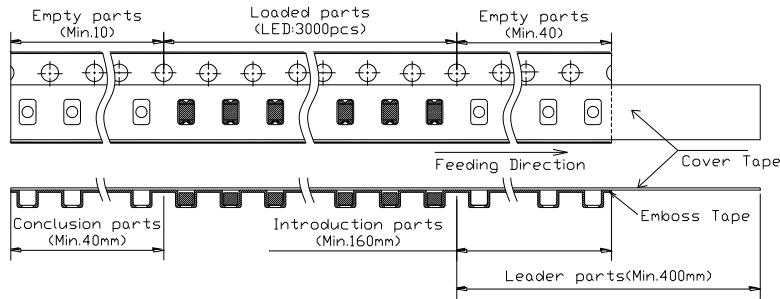

Packaging Specification:

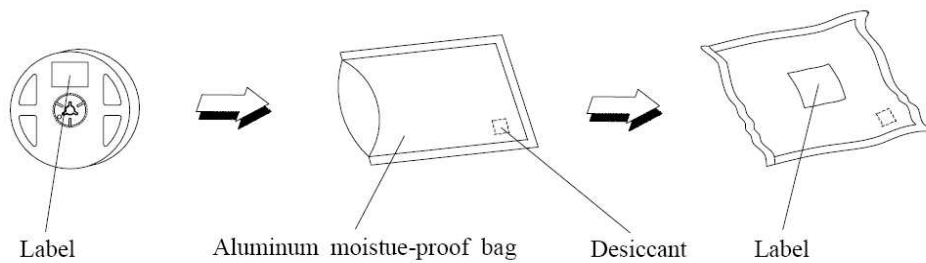

Product: QBLP630-IR3	Date: May 04, 2015	Page 7 of 9
	Version# 1.1	

Labeling

Part No: _____

Customer P/N: _____

Item: _____

Q'ty: _____

Vf: _____

Iv: _____

WI: _____

Date: _____

Made in China**Ordering Information**

Part #	Orderable Part #	Spec Range	Quantity per reel
QBLP630-IR3	QBLP630-IR3	Ie=0.6mW/sr typ. @ I _F =20mA / λ _P =850nm typ.	3,000 units

Product: QBLP630-IR3	Date: May 04, 2015	Page 8 of 9
	Version# 1.1	

Revision History

Description:	Revision #	Revision Date
New Release of QBLP630-IR3	V1.0	02/09/2015
Update le spec	V1.1	05/04/2015

Disclaimer

QT-BRIGHTTEK reserves the right to make changes without further notice to any products herein to improve reliability, function or design. QT-BRIGHTTEK does not assume any liability arising out of the application or use of any product or circuit described herein; neither does it convey any license under its patent rights, nor the rights of others.

Life Support Policy

QT-BRIGHTTEK's products are not authorized for use as critical components in life support devices or systems without the express written approval of QT-BRIGHTTEK. As used herein:

1. Life support devices or systems are devices or systems which, (a) are intended for surgical implant into the body, or (b) support or sustain life, and (c) whose failure to perform when properly used in accordance with instructions for use provided in the labeling, can be reasonably expected to result in a significant injury of the user.
2. A critical component in any component of a life support device or system whose failure to perform can be reasonably expected to cause the failure of the life support device or system, or to affect its safety or effectiveness.

Product: QBLP630-IR3	Date: May 04, 2015	Page 9 of 9
	Version# 1.1	