



Chipsmall Limited consists of a professional team with an average of over 10 year of expertise in the distribution of electronic components. Based in Hongkong, we have already established firm and mutual-benefit business relationships with customers from,Europe,America and south Asia,supplying obsolete and hard-to-find components to meet their specific needs.

With the principle of “Quality Parts,Customers Priority,Honest Operation,and Considerate Service”,our business mainly focus on the distribution of electronic components. Line cards we deal with include Microchip,ALPS,ROHM,Xilinx,Pulse,ON,Everlight and Freescale. Main products comprise IC,Modules,Potentiometer,IC Socket,Relay,Connector.Our parts cover such applications as commercial,industrial, and automotives areas.

We are looking forward to setting up business relationship with you and hope to provide you with the best service and solution. Let us make a better world for our industry!



## Contact us

Tel: +86-755-8981 8866 Fax: +86-755-8427 6832

Email & Skype: info@chipsmall.com Web: www.chipsmall.com

Address: A1208, Overseas Decoration Building, #122 Zhenhua RD., Futian, Shenzhen, China



**QT-Brightek PLCC Series**

**3014 PLCC2 LED**

**Part No.: QBLP674-XX Series**

Product: QBLP674-XX Series	Date: August 29, 2014	Page 1 of 12
	Version# 2.3	

---

**Table of Contents:**

Introduction .....	3
Electrical / Optical Characteristic (Ta=25 °C) .....	4
Absolute Maximum Rating .....	4
Characteristic Curves.....	7
Solder Profile & Footprint.....	9
Packing .....	10
Labeling .....	11
Ordering Information .....	11
Revision History .....	12
Disclaimer .....	12

## Introduction

### Feature:

- Package in tape and reel
- Ultra bright reflector type 3014 PLCC2 LED
- InGaN technology for IB/IG
- AlInGaP technology for R/AG/Y/O/S
- 120 degree viewing angle

### Description:

These ultra bright reflector type 3014 PLCC2 LEDs have a height profile of 0.75mm. Combination of high brightness output and robust package, these LEDs are ideal for architecture lighting, status indication, and industrial equipment lighting applications.

### Application:

- Status indication
- Industrial equipment backlighting
- Architecture lighting

### Certification & Compliance:

- TS16949
- ISO9001
- RoHS Compliant



### Dimension:

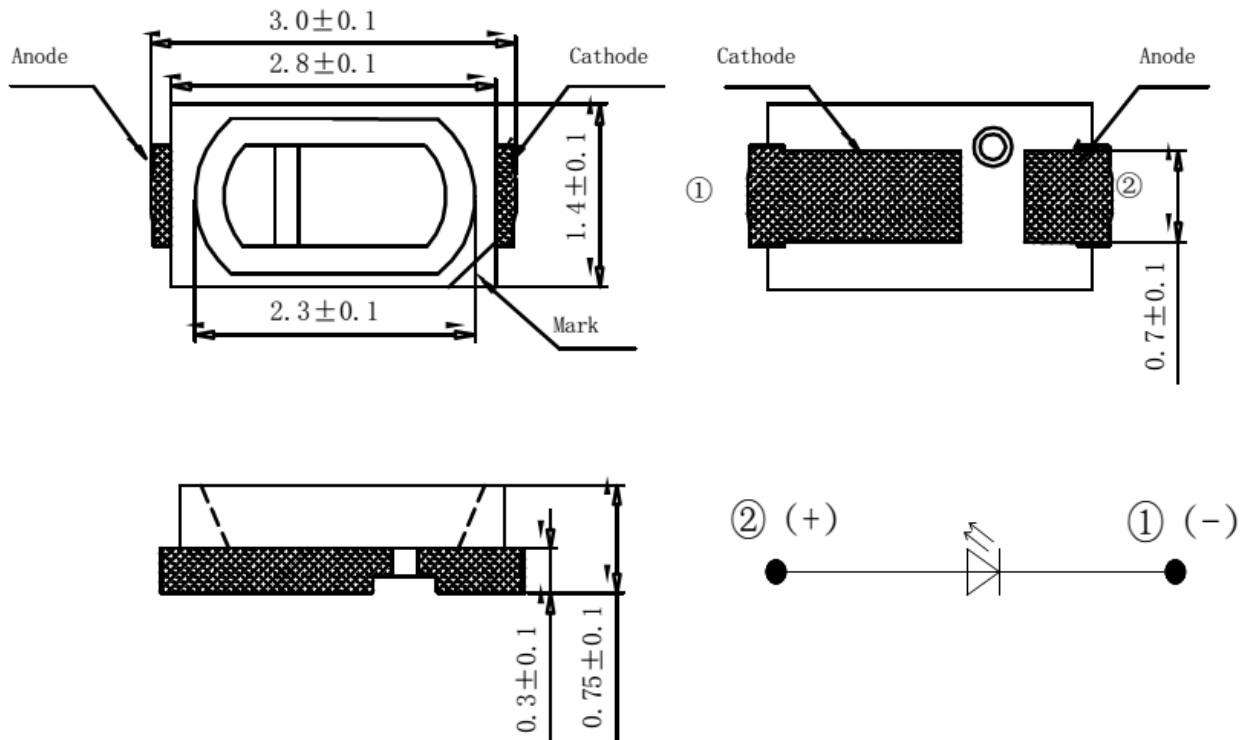

Units: mm / tolerance = +/-0.1mm

**Electrical / Optical Characteristic (Ta=25 °C)**

Product	Color	I <sub>F</sub> (mA)	V <sub>F</sub> (V)		λ <sub>D</sub> (nm)			I <sub>V</sub> (mcd)	
			Typ.	Max.	Min.	Typ.	Max.	Min.	Typ.
QBLP674-IB	Blue	20	3.1	3.7	465	470	475	100	210
QBLP674-IG	True Green	20	3.1	3.7	520	525	530	500	900
QBLP674-R	Red	20	2.0	2.5	615	620	630	125	230
QBLP674-AG	Yellow Green	20	2.0	2.5	565	570	576	40	80
QBLP674-Y	Yellow	20	2.0	2.5	585	590	595	125	210
QBLP674-O	Orange	20	2.0	2.5	600	605	610	125	240
QBLP674-S	Deep Red	20	2.0	2.5	630	640	650	50	80

**Absolute Maximum Rating**

Material	P <sub>d</sub> (mW)	I <sub>F</sub> (mA)	I <sub>FP</sub> (mA)*	V <sub>R</sub> (V)	T <sub>OP</sub> (°C)	T <sub>ST</sub> (°C)	T <sub>SOL</sub> (°C)**
AllnGaP (R/AG/Y/O/S)	75	30	125	5	-30 ~ +85	-40 ~ +100	260
InGaN (IB/IG)	120	30	100	5	-30 ~ +85	-40 ~ +100	260

\*Duty 1/10 @ 1KHz

\*\* IR Reflow for no more than 10 sec @ 260 °C

**Forward Voltage V<sub>F</sub> for AllnGaP @ I<sub>F</sub>=20mA**

Bin	Min.	Max.	Unit
□	1.7	2.5	V

**Forward Voltage V<sub>F</sub> for InGaN @ I<sub>F</sub>=20mA**

Bin	Min.	Max.	Unit
e	2.5	2.8	V
f	2.8	3.1	
g	3.1	3.4	
h	3.4	3.7	



**Dominant Wavelength  $\lambda_D$  for Blue @  $I_F=20mA$** 

Bin	Min.	Max.	Unit
G	465	467.5	nm
H	467.5	470	
I	470	472.5	
J	472.5	475	

**Dominant Wavelength  $\lambda_D$  for Green @  $I_F=20mA$** 

Bin	Min.	Max.	Unit
U	520	522.5	nm
V	522.5	525	
W	525	527.5	
X	527.5	530	

**Dominant Wavelength  $\lambda_D$  for Red @  $I_F=20mA$** 

Bin	Min.	Max.	Unit
s	615	620	nm
t	620	625	
u	625	630	

**Dominant Wavelength  $\lambda_D$  for Yellow Green @  $I_F=20mA$** 

Bin	Min.	Max.	Unit
h	565	568	nm
i	568	572	
j	572	576	

**Dominant Wavelength  $\lambda_D$  for Yellow @  $I_F=20mA$** 

Bin	Min.	Max.	Unit
m	585	590	nm
n	590	595	

**Dominant Wavelength  $\lambda_D$  for Orange @  $I_F=20mA$** 

Bin	Min.	Max.	Unit
p	600	605	nm
q	605	610	

**Dominant Wavelength  $\lambda_D$  for Deep Red @  $I_F=20mA$** 

Bin	Min.	Max.	Unit
v	630	635	nm
w	635	650	

**Luminous Intensity  $I_V$  @  $I_F=20mA$** 

Bin	Min.	Max.	Unit
F	40	50	mcd
G	50	63	
H	63	80	
I	80	100	
J	100	125	
K	125	160	
L	160	200	
M	200	250	
N	250	320	
O	320	400	
P	400	500	
Q	500	630	
R	630	800	
S	800	1000	
T	1000	1250	
U	1250	1600	
V	1600	2000	
W	2000	2500	
X	2500	3200	

**Note:**Tolerance of measurement of forward voltage:  $\pm 0.1V$ Tolerance of measurement of dominant wavelength:  $\pm 1nm$ Tolerance of measurement of luminous intensity:  $\pm 10\%$

**Characteristic Curves**

AllnGaP (R/AG/Y/O/S)

FORWARD CURRENT VS. FORWARD VOLTAGE

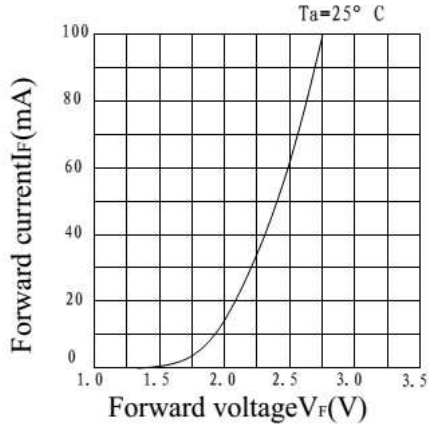

RELATIVE LUMINOUS INTENSITY VS. FORWARD CURRENT

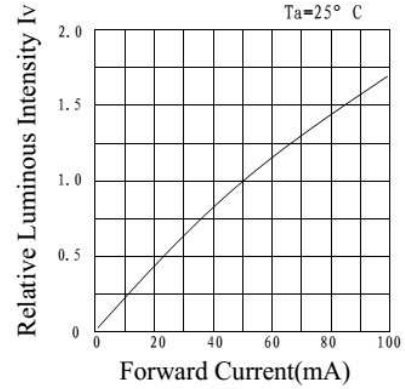

FORWARD CURRENT VS. AMBIENT TEMPERATURE

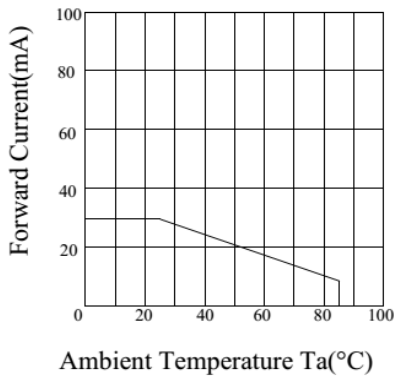

RELATIVE INTENSITY VS. AMBIENT TEMPERATURE

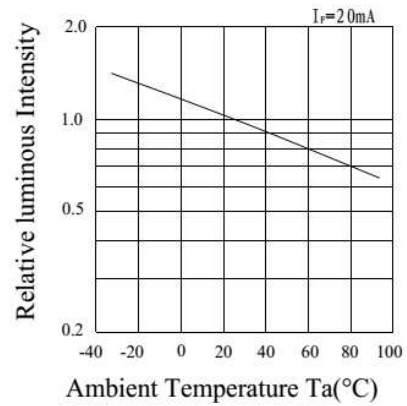

Relative Intensity vs. Wavelength

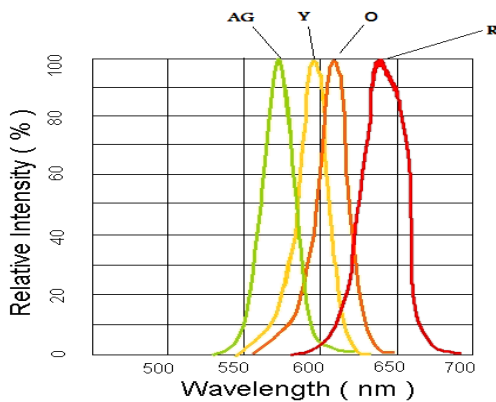

RADIATION PATTERN

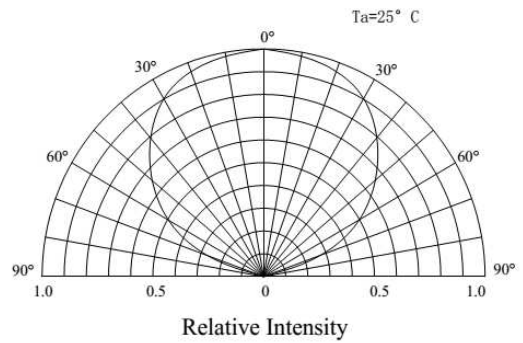



InGaN (IB/IG)

FORWARD CURRENT VS. FORWARD VOLTAGE

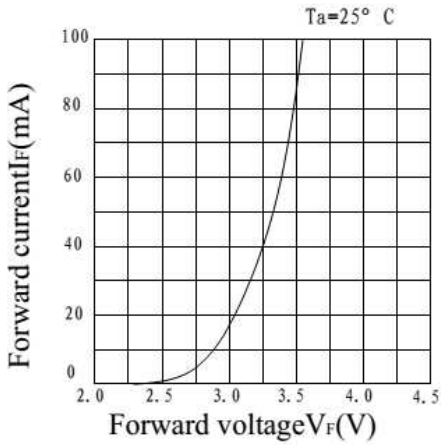

RELATIVE LUMINOUS INTENSITY VS. FORWARD CURRENT

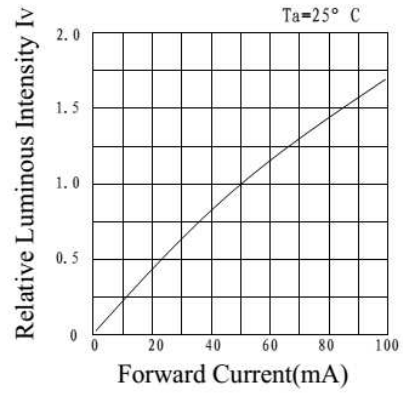

FORWARD CURRENT VS. AMBIENT TEMPERATURE

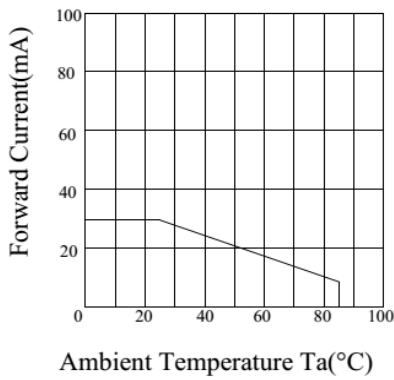

RELATIVE INTENSITY VS. AMBIENT TEMPERATURE

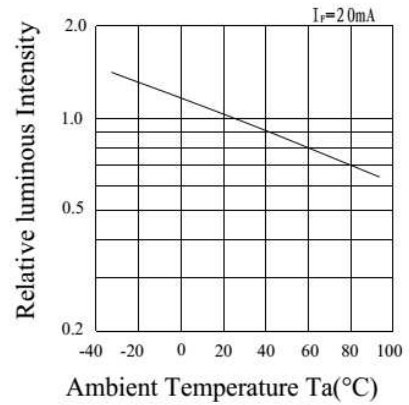

Relative Intensity vs. Wavelength

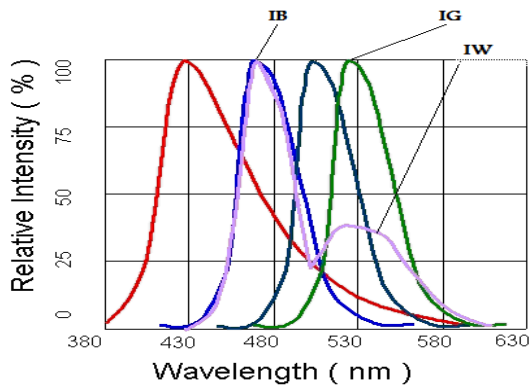

RADIATION PATTERN

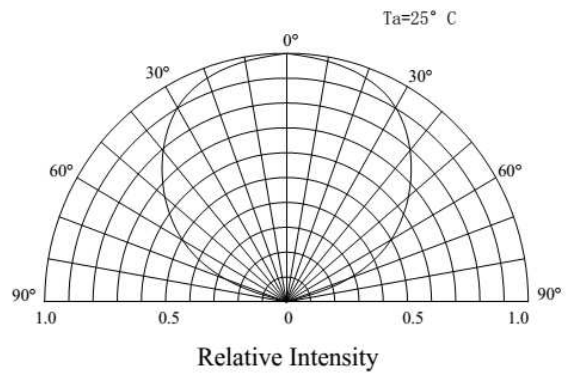

## Solder Profile & Footprint

- Recommended tin solder specifications: melting temperature in the range of 178~192 °C
- The recommended reflow soldering profile is as follows (temperatures indicated are as measured on the surface of the LED resin):

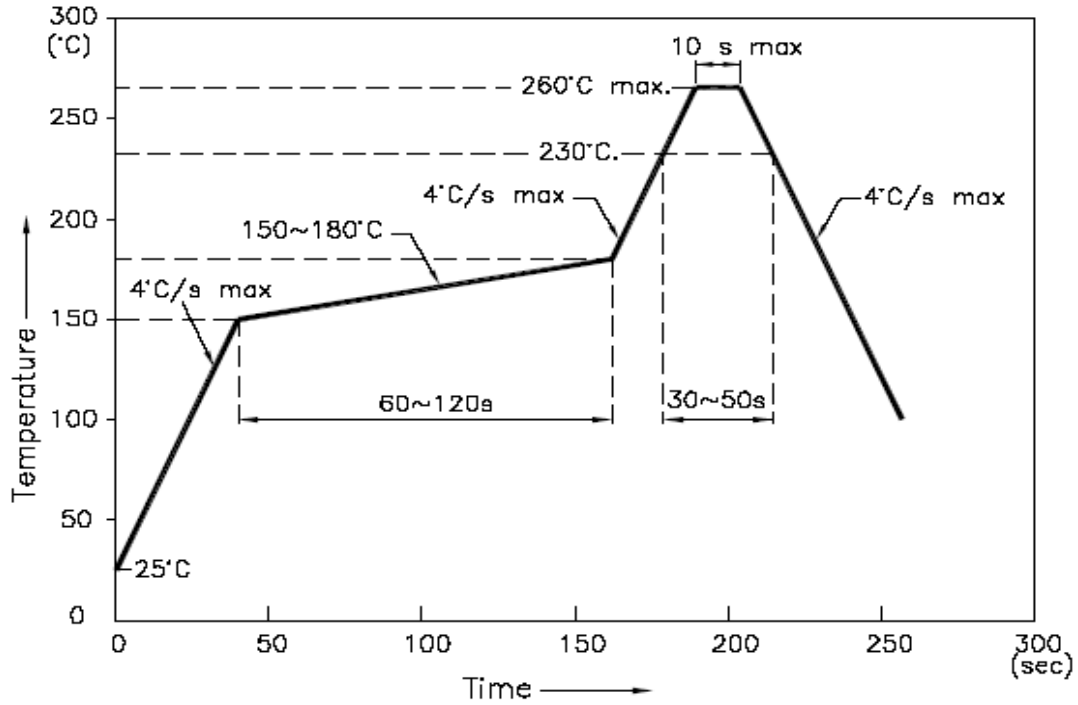

### Recommended Pad Layout

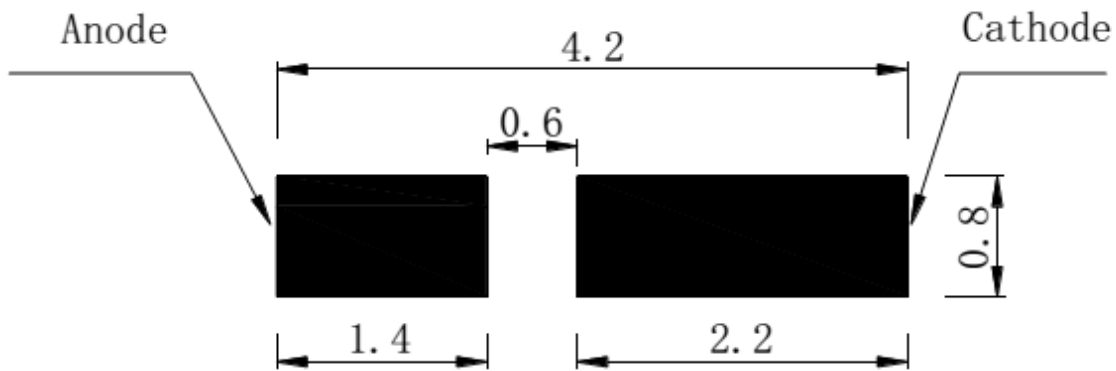

Units: mm

Tolerance: ± 0.2mm

## Packing

Reel Dimension:

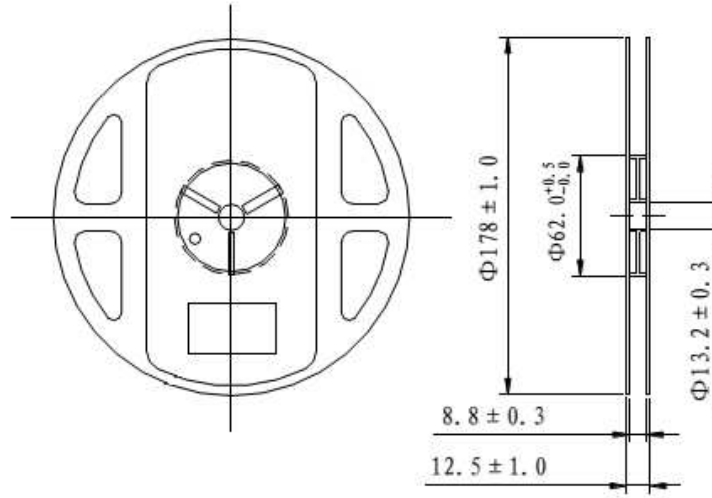

Unit: mm

Tape Dimension:

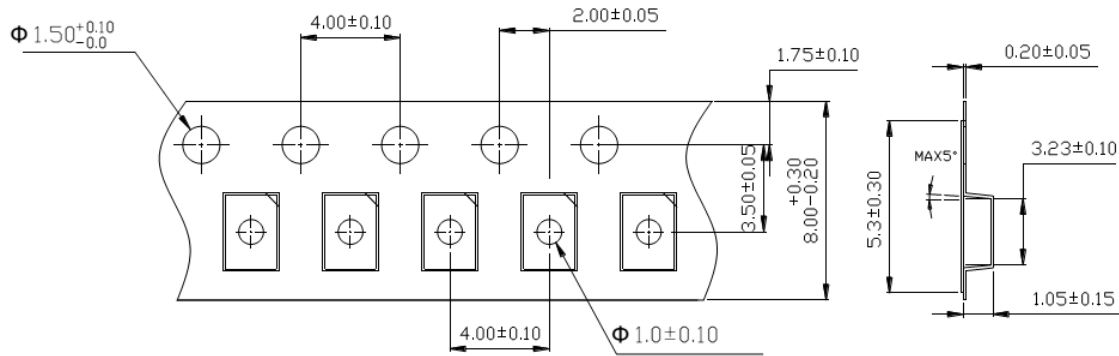

Unit: mm

Packaging Specification:

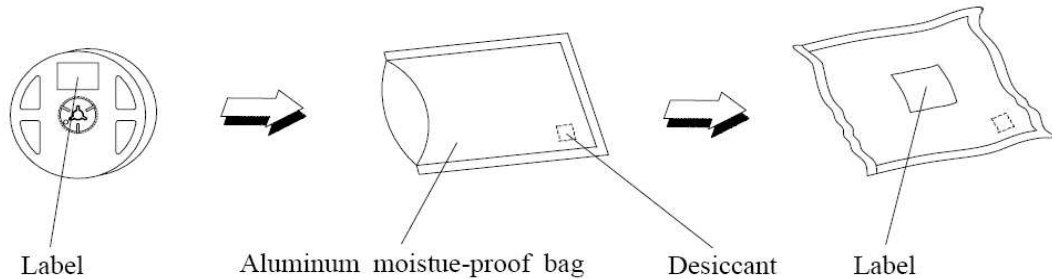

**Labeling**



Part No: \_\_\_\_\_  
 Customer P/N: \_\_\_\_\_  
 Item: \_\_\_\_\_  
 Q'ty: \_\_\_\_\_  
 Vf: \_\_\_\_\_  
 Iv: \_\_\_\_\_  
 Wl: \_\_\_\_\_  
 Date: \_\_\_\_\_

**Made in China**

**Ordering Information**

Part #	Orderable Part #	Spec Range	Quantity per reel
QBLP674-IB	QBLP674-IB	Iv=210 mcd typ. @ 20mA/ Color=465nm to 475nm	2,000 units
QBLP674-IG	QBLP674-IG	Iv=900mcd typ. @ 20mA/ Color=520nm to 530nm	2,000 units
QBLP674-R	QBLP674-R	Iv=230mcd typ. @ 20mA/ Color=615nm to 630nm	2,000 units
QBLP674-AG	QBLP674-AG	Iv=80mcd typ. @ 20mA/ Color=565nm to 576nm	2,000 units
QBLP674-Y	QBLP674-Y	Iv=210mcd typ. @ 20mA/ Color=585nm to 595nm	2,000 units
QBLP674-O	QBLP674-O	Iv=240mcd typ. @ 20mA/ Color=600nm to 610nm	2,000 units
QBLP674-S	QBLP674-S	Iv=80mcd typ. @ 20mA/ Color=630nm to 650nm	2,000 units

## Revision History

Description:	Revision #	Revision Date
New Release of QBLP674-XX Series	V1.0	02/20/2013
Update spec and drawing	V2.0	11/12/2013
Update drawing tolerance	V2.1	12/06/2013
Update luminous intensity bin	V2.2	06/02/2014
Update VF bin for InGaN	V2.3	08/29/2014

## Disclaimer

QT-BRIGHTTEK reserves the right to make changes without further notice to any products herein to improve reliability, function or design. QT-BRIGHTTEK does not assume any liability arising out of the application or use of any product or circuit described herein; neither does it convey any license under its patent rights, nor the rights of others.

## Life Support Policy

QT-BRIGHTTEK's products are not authorized for use as critical components in life support devices or systems without the express written approval of QT-BRIGHTTEK. As used herein:

1. Life support devices or systems are devices or systems which, (a) are intended for surgical implant into the body, or (b) support or sustain life, and (c) whose failure to perform when properly used in accordance with instructions for use provided in the labeling, can be reasonably expected to result in a significant injury of the user.
2. A critical component in any component of a life support device or system whose failure to perform can be reasonably expected to cause the failure of the life support device or system, or to affect its safety or effectiveness.