



Chipsmall Limited consists of a professional team with an average of over 10 year of expertise in the distribution of electronic components. Based in Hongkong, we have already established firm and mutual-benefit business relationships with customers from,Europe,America and south Asia,supplying obsolete and hard-to-find components to meet their specific needs.

With the principle of “Quality Parts,Customers Priority,Honest Operation,and Considerate Service”,our business mainly focus on the distribution of electronic components. Line cards we deal with include Microchip,ALPS,ROHM,Xilinx,Pulse,ON,Everlight and Freescale. Main products comprise IC,Modules,Potentiometer,IC Socket,Relay,Connector.Our parts cover such applications as commercial,industrial, and automotives areas.

We are looking forward to setting up business relationship with you and hope to provide you with the best service and solution. Let us make a better world for our industry!



Contact us

Tel: +86-755-8981 8866 Fax: +86-755-8427 6832

Email & Skype: info@chipsmall.com Web: www.chipsmall.com

Address: A1208, Overseas Decoration Building, #122 Zhenhua RD., Futian, Shenzhen, China





POWER SUPPLY

- AC 100-240V Wide-range Input
- DeviceNet® Approved
- NEC Class 1 Compliant
- Width only 60mm
- Efficiency up to 93.4%
- Active Power Factor Correction (PFC)
- Negligible low Inrush Current Surge
- Short-term Operation down to 60Vac and up to 300Vac
- Full Power Between -25°C and +60°C
- DC-OK Relay Contact
- Quick-connect Spring-clamp Terminals
- 3 Year Warranty

GENERAL DESCRIPTION

The QS10.DNET power supply is a derivate of the Dimension QS10 family, which is specially designed to meet the DeviceNet® requirement. The QS10.DNET exists beside the QS5.DNET, which is the right choice to supply networks that use NEC Class 2 cables.

The specialties of DeviceNet® power supplies are:

- The nominal and overload currents are sized for the ratings of the DeviceNet® cables.
- Large load capacitors can be charged in a very short period of time.
- After turn on, the output voltage increases according to the DeviceNet® timing specification.
- The upper level of the output level is limited to protect the network.

The most outstanding features are a high efficiency, compact size, wide-range input voltage, a very low inrush surge and a DC-ok contact. High immunity to transients and power surges and a low electromagnetic emission makes usage in nearly every environment possible.

Unique quick-connect spring-clamp terminals allow a safe and fast installation. A large international approval package makes this unit suitable for nearly every situation.

ORDER NUMBERS

Power Supply	QS10.DNET	24V Power supply
Accessory	ZM1.WALL	Wall mount bracket
	ZM13.SIDE	Side mount bracket
	UF20.241	Buffer unit

SHORT-FORM DATA

Output voltage	DC 24V	
Adjustment range	24 – 24.5V	
Output current	8A	
Output power	192W	
Output ripple	< 50mVpp	20Hz to 20MHz
Input voltage	AC 100-240V	±15%
Mains frequency	50-60Hz	±6%
AC Input current	1.77 / 1.0A	at 120 / 230Vac
Power factor	0.98 / 0.92	at 120 / 230Vac
AC Inrush current	typ. 4 / 7A peak	at 120 / 230Vac
Efficiency	92.8 / 93.4%	at 120 / 230Vac
Losses	14.9 / 13.6W	at 120 / 230Vac
Temperature range	-25°C to +70°C	operational
Derating	5W/°C	+60 to +70°C
Hold-up time	typ. 33 / 34ms	at 120 / 230Vac
Dimensions	60x124x117mm	WxHxD

MARKINGS



INDEX

	Page		Page
1. Intended Use	3	20. Physical Dimensions and Weight	17
2. Installation Requirements.....	3	21. Accessories	18
3. AC-Input.....	4	21.1. ZM1.WALL Wall Mounting Bracket.....	18
4. DC-Input.....	5	21.2. ZM13.SIDE Side Mounting Bracket.....	18
5. Input Inrush Current	5	21.3. UF20.241 Buffer Module	18
6. Output	6	22. Application Notes.....	19
7. Hold-up Time.....	7	22.1. Peak Current Capability	19
8. DC-OK Relay Contact	7	22.2. Back-feeding Loads	19
9. Efficiency and Power Losses.....	8	22.3. External Input Protection.....	20
10. Reliability.....	9	22.4. Charging of Batteries	20
11. Functional Diagram.....	10	22.5. Output Circuit Breakers.....	20
12. Terminals and Wiring.....	10	22.6. Parallel Use to Increase Output Power....	21
13. Front Side and User Elements.....	11	22.7. Parallel Use for Redundancy	21
14. EMC.....	12	22.8. Series Operation	21
15. Environment.....	13	22.9. Inductive and Capacitive Loads.....	21
16. Protection Features	14	22.10. Operation on Two Phases	21
17. Safety Features	14	22.11. Use in a Tightly Sealed Enclosure	21
18. Dielectric Strength	15		
19. Approvals.....	16		

The information presented in this document is believed to be accurate and reliable and may change without notice. No part of this document may be reproduced or utilized in any form without permission in writing from the publisher.

TERMINOLOGY AND ABBREVIATIONS

PE and \oplus symbol	PE is the abbreviation for Protective Earth and has the same meaning as the symbol \oplus .
Earth, Ground	This document uses the term "earth" which is the same as the U.S. term "ground".
T.b.d.	To be defined, value or description will follow later.
AC 230V	A figure displayed with the AC or DC before the value represents a nominal voltage with standard tolerances (usually $\pm 15\%$) included. E.g.: DC 12V describes a 12V battery disregarding whether it is full (13.7V) or flat (10V)
230Vac	A figure with the unit (Vac) at the end is a momentary figure without any additional tolerances included.
50Hz vs. 60Hz	As long as not otherwise stated, AC 230V parameters are valid at 50Hz mains frequency.
may	A key word indicating flexibility of choice with no implied preference.
shall	A key word indicating a mandatory requirement.
should	A key word indicating flexibility of choice with a strongly preferred implementation.

1. INTENDED USE

This device is designed for installation in an enclosure and is intended for the general use such as in industrial control, office, communication, and instrumentation equipment.

Do not use this power supply in aircraft, trains, nuclear equipment or similar systems where malfunction may cause severe personal injury or threaten human life.

This device is designed for use in hazardous, non-hazardous, ordinary or unclassified locations.

2. INSTALLATION REQUIREMENTS

This device may only be installed and put into operation by qualified personnel.

This device does not contain serviceable parts. The tripping of an internal fuse is caused by an internal defect.

If damage or malfunction should occur during installation or operation, immediately turn power off and send unit to the factory for inspection.

Mount the unit on a DIN-rail so that the output terminals are located on the top and the input terminals are located on the bottom of the unit. For other mounting orientations see de-rating requirements in this document. See chapter 0.

This device is designed for convection cooling and does not require an external fan. Do not obstruct airflow and do not cover ventilation grid (e.g. cable conduits) by more than 30%!

Keep the following installation clearances: 40mm on top, 20mm on the bottom, 5mm on the left and right sides are recommended when the device is loaded permanently with more than 50% of the rated power. Increase this clearance to 15mm in case the adjacent device is a heat source (e.g. another power supply).

⚠ WARNING Risk of electrical shock, fire, personal injury or death.

- Do not use the power supply without proper grounding (Protective Earth). Use the terminal on the input block for earth connection and not one of the screws on the housing.
- Turn power off before working on the device. Protect against inadvertent re-powering.
- Make sure that the wiring is correct by following all local and national codes.
- Do not modify or repair the unit.
- Do not open the unit as high voltages are present inside.
- Use caution to prevent any foreign objects from entering the housing.
- Do not use in wet locations or in areas where moisture or condensation can be expected.
- Do not touch during power-on, and immediately after power-off. Hot surfaces may cause burns.

3. AC-INPUT

AC input	nom.	AC 100-240V	suitable for TN-, TT- and IT mains networks
AC input range	min.	85-276Vac	continuous operation
	min.	60-85Vac	full power for 200ms, no damage between 0 and 85Vac
	min.	276-300Vac	< 500ms
Allowed voltage L or N to earth	max.	276Vac	continuous, IEC 62103
Input frequency	nom.	50–60Hz	±6%
Turn-on voltage	typ.	81Vac	steady-state value, see Fig. 3-1
Shut-down voltage	typ.	63Vac	steady-state value, see Fig. 3-1
	typ.	55Vac	dynamic value
External input protection	See recommendations in chapter 22.3.		

		AC 100V	AC 120V	AC 230V	
Input current	typ.	2.13A	1.77A	1.0A	at 24V, 8A, see Fig. 3-3
Power factor *)	typ.	0.99	0.98	0.92	at 24V, 8A, see Fig. 3-4
Crest factor **)	typ.	1.65	1.67	1.85	at 24V, 8A
Start-up delay	typ.	800ms	650ms	340ms	see Fig. 3-2
Rise time	typ.	8ms	8ms	8ms	0mF, 24V, 8A, see Fig. 3-2
	typ.	15ms	15ms	15ms	8mF, 24V, 8A, see Fig. 3-2
Turn-on overshoot	max.	100mV	100mV	100mV	see Fig. 3-2

*) The power factor is the ratio of the true (or real) power to the apparent power in an AC circuit.

**) The crest factor is the mathematical ratio of the peak value to RMS value of the input current waveform.

Fig. 3-1 Input voltage range

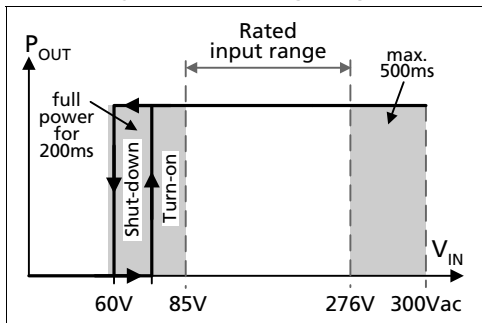

Fig. 3-2 Turn-on behavior, definitions

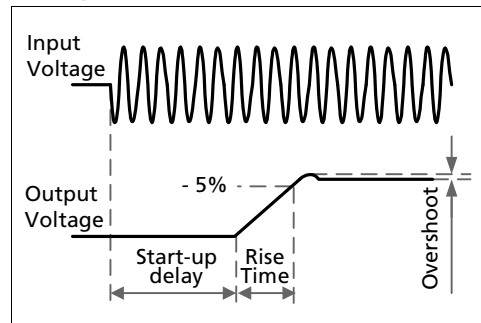

Fig. 3-3 Input current vs. output load at 24V

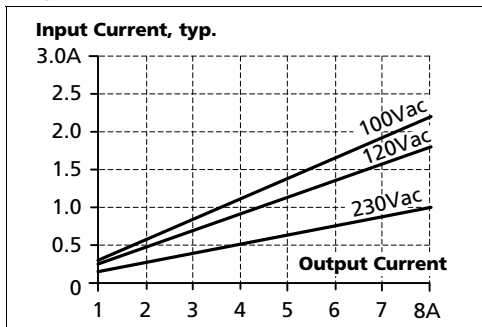
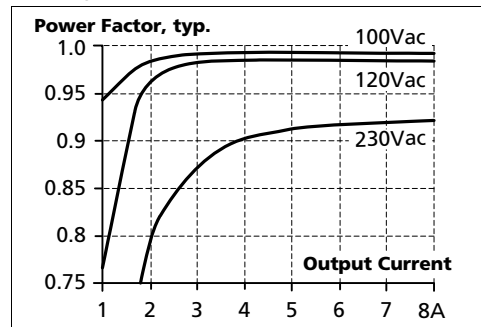

Fig. 3-4 Power factor vs. output load



4. DC-INPUT

DC input	nom.	DC 110-150V	-20%/+25%
DC input range	min.	88-187Vdc	continuous operation
DC input current	typ.	1.9A	110Vdc, at 24V, 8A
Allowed Voltage L/N to Earth	max.	375Vdc	continuous, IEC 62103
Turn-on voltage	typ.	80Vdc	steady state value
Shut-down voltage	typ.	55Vdc	steady state value

Fig. 4-1 Wiring for DC Input

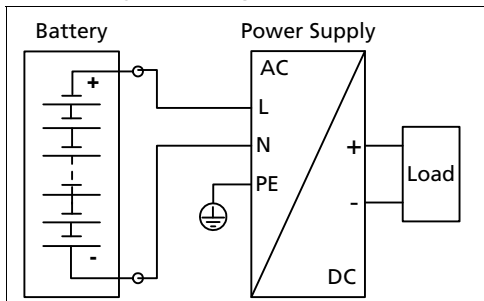

Instructions for DC use:

- Use a battery or similar DC source. For other sources contact PULS
- Connect +pole to L and -pole to N.
- Connect the PE terminal to a earth wire or to the machine ground.

5. INPUT INRUSH CURRENT

An active inrush limitation circuit limits the input inrush current after turn-on of the input voltage and after short input voltage interruptions.

The charging current into EMI suppression capacitors is disregarded in the first microseconds after switch-on.

		AC 100V	AC 120V	AC 230V	
Inrush current	max.	10A _{peak}	10A _{peak}	10A _{peak}	over entire temperature range
	typ.	5A _{peak}	4A _{peak}	7A _{peak}	over entire temperature range
Inrush energy	max.	4A ² s	4A ² s	4A ² s	over entire temperature range
Inrush delay (A)	typ.	650ms	520ms	250ms	see (A) in Fig. 5-1

Fig. 5-1 Input inrush current, typical behavior

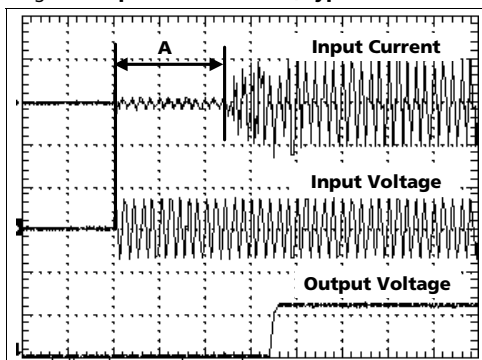

A.... Inrush delay

Input: 230Vac
 Output: 24V, 8A
 Ambient: 25°C
 Upper curve: Input current 2A / DIV
 Middle curve: Input voltage 500V / DIV
 Lower curve: Output voltage 20V / DIV
 Time basis: 100ms / DIV

6. OUTPUT

Output voltage	nom.	24V	
Adjustment range	min.	24-24.5V	guaranteed
	max.	25V ^{*)}	at clockwise end position of potentiometer
Factory setting	typ.	24.1V	±0.2%, at full load, cold unit
Line regulation	max.	10mV	60-300Vac
Load regulation	max.	100mV	static value, 0A → 8A
Ripple and noise voltage	max.	50mVpp	20Hz to 20MHz, 50Ohm
Output current	nom.	8A	continuously available at 24V, see Fig. 6-1
	nom.	12A	for typ. 200ms to charge network capacitors ^{***)}
Output power	nom.	192W	continuously available at 24V
Overload behaviour	cont. current		
Short-circuit current	min.	7A ^{**)}	continuous, load impedance 100mOhm, see Fig. 6-1
	max.	10A ^{**)}	continuous, load impedance 100mOhm, see Fig. 6-1
	max.	13A ^{**)}	for the first 200ms after the short across the output, load impedance 100mOhm
Output capacitance	typ.	7 000µF	included inside the power supply

^{*)} This is the maximum output voltage which can occur at the clockwise end position of the potentiometer due to tolerances. It is not guaranteed value which can be achieved. The typical value is about 24.8V.

^{**)} Discharge current of output capacitors is not included.

^{***)} The extra current to charge network capacitors is available as soon as power comes on and immediately after the end of an output short circuit or output overload.

Peak current capability (up to several milliseconds)

The power supply can deliver a peak current which is higher than the specified short term current. This helps to start current demanding loads or to safely operate subsequent circuit breakers.

The extra current is supplied by the output capacitors inside the power supply. During this event, the capacitors will be discharged and causes a voltage dip on the output. Detailed curves can be found in chapter 22.1.

Peak current voltage dips	typ.	from 24V to 18.5V	at 16A for 50ms, resistive load
	typ.	from 24V to 20V	at 32A for 2ms, resistive load
	typ.	from 24V to 16.5V	at 32A for 5ms, resistive load

Fig. 6-1 Output voltage vs. output current, typ.

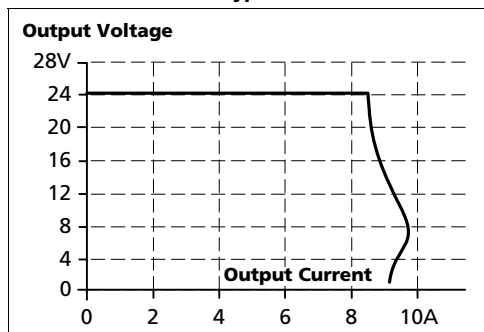

7. HOLD-UP TIME

		AC 100V	AC 120V	AC 230V	
Hold-up Time	typ.	72ms	72ms	73ms	at 24V, 4A, see Fig. 7-1
	typ.	31ms	32ms	32ms	at 24V, 8A, see Fig. 7-1

Fig. 7-1 Hold-up time vs. input voltage

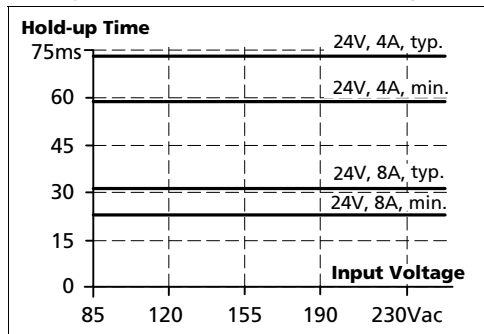
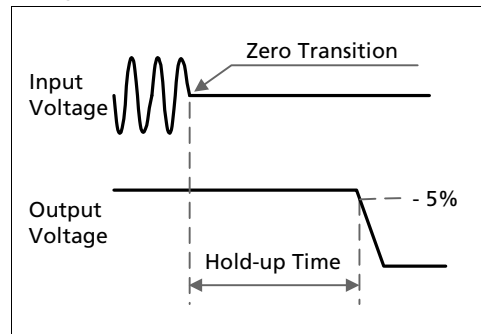

Fig. 7-2 Shut-down behavior, definitions



8. DC-OK RELAY CONTACT

This feature monitors the output voltage, which is produced by the power supply itself. It is independent of a back-fed voltage from a unit connected in parallel to the power supply output.

Contact closes	As soon as the output voltage reaches the adjusted output voltage level.		
Contact opens	As soon as the output voltage dips more than 10% below the adjusted output voltage. Short dips will be extended to a signal length of 250ms. Dips shorter than 1ms will be ignored.		
Contact re-closes	As soon as the output voltage exceeds 90% of the adjusted voltage.		
Contact ratings	max	60Vdc 0.3A, 30Vdc 1A, 30Vac 0.5A	resistive load
	min	1mA at 5Vdc	min. permissible load
Isolation voltage	See dielectric strength table in section 18.		

Fig. 8-1 DC-ok relay contact behavior

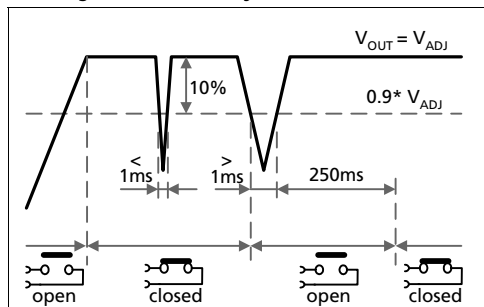

Note: The DC-ok feature requires that the output voltage reaches the nominal (=adjusted) level after turn-on in order to function according to specification. If this level cannot be achieved, the overload lamp will be on and the DC-ok contact will be open. The overload signal will only shut off as soon as the adjusted voltage is reached. This is an important condition to consider particularly, if the load is a battery, the power supply is used in parallel or the power supply is used for N+1 redundant systems.

9. EFFICIENCY AND POWER LOSSES

		AC 100V	AC 120V	AC 230V	
Efficiency	typ.	92.3%	92.8%	93.4%	at 24V, 8A
Average efficiency *)	typ.	90.8%	91.2%	91.0%	25% at 2A, 25% at 4A, 25% at 6A, 25% at 8A
Power losses	typ.	4.4W	4.9W	6.1W	at 24V, 0A
	typ.	16.0W	14.9W	13.6W	at 24V, 8A

*) The average efficiency is an assumption for a typical application where the power supply is loaded with 25% of the nominal load for 25% of the time, 50% of the nominal load for another 25% of the time, 75% of the nominal load for another 25% of the time and with 100% of the nominal load for the rest of the time.

Fig. 9-1 Efficiency vs. output current at 24V, typ.

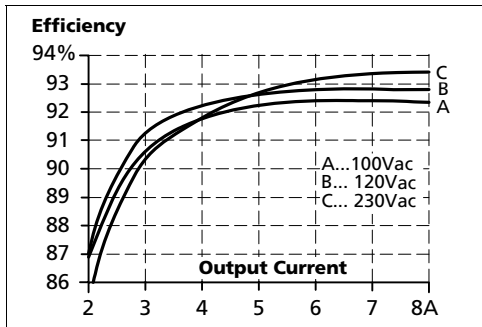

Fig. 9-2 Losses vs. output current at 24V, typ.

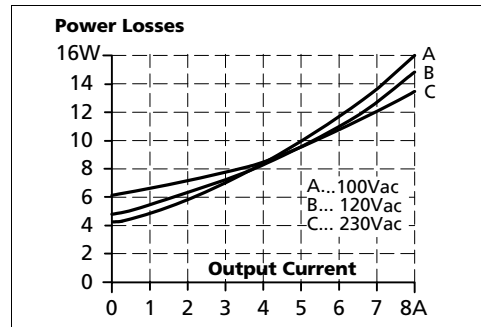

Fig. 9-3 Efficiency vs. input voltage at 24V, 8A, typ.

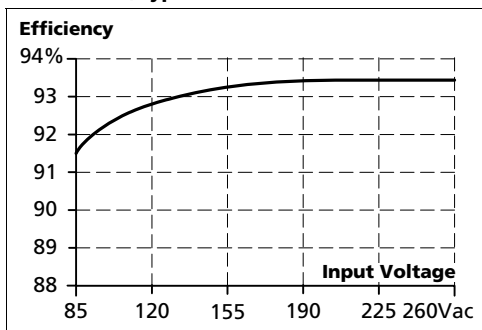
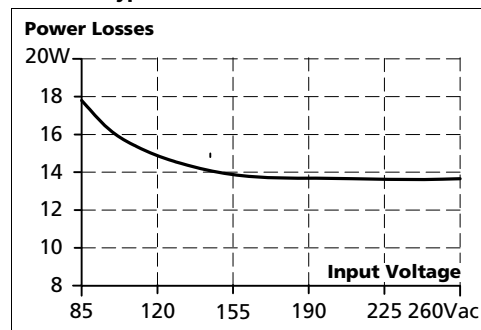

Fig. 9-4 Losses vs. input voltage at 24V, 8A, typ.



10. RELIABILITY

	AC 100V	AC 120V	AC 230V	
Lifetime expectancy *)	66 000h	77 000h	81 000h	at 24V, 8A and 40°C
	133 000h	139 000h	133 000h	at 24V, 4A and 40°C
	188 000h*)	219 000h*)	228 000h*)	at 24V, 8A and 25°C
MTBF **) SN 29500, IEC 61709	478 000h	535 000h	581 000h	at 24V, 8A and 40°C
	827 000h	926 000h	1 005 000h	at 24V, 8A and 25°C
MTBF **) MIL HDBK 217F	334 000h	341 000h	345 000h	at 24V, 8A and 40°C; Ground Benign GB40
	460 000h	469 000h	474 000h	at 24V, 8A and 25°C; Ground Benign GB25

*) The **Lifetime expectancy** shown in the table indicates the minimum operating hours (service life) and is determined by the lifetime expectancy of the built-in electrolytic capacitors. Lifetime expectancy is specified in operational hours and is calculated according to the capacitor's manufacturer specification. The manufacturer of the electrolytic capacitors only guarantees a maximum life of up to 15 years (131 400h). Any number exceeding this value is a calculated theoretical lifetime which can be used to compare devices.

) **MTBF stands for **Mean Time Between Failure**, which is calculated according to statistical device failures, and indicates reliability of a device. It is the statistical representation of the likelihood of a unit to fail and does not necessarily represent the life of a product. The MTBF figure is a statistical representation of the likelihood of a device to fail. A MTBF figure of e.g. 1 000 000h means that statistically one unit will fail every 100 hours if 10 000 units are installed in the field. However, it can not be determined if the failed unit has been running for 50 000h or only for 100h.

11. FUNCTIONAL DIAGRAM

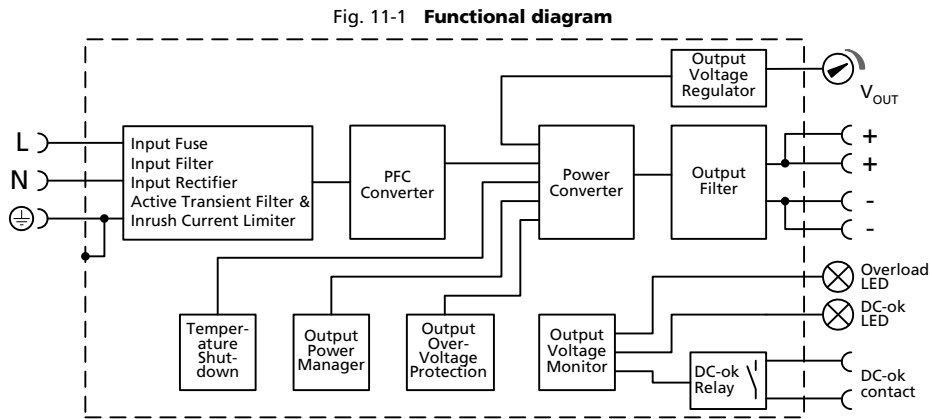

12. TERMINALS AND WIRING

Bi-stable, quick-connect spring clamp terminals. IP20 Finger safe construction. Suitable for field- and factory installation. Shipped in open position.

	Input	Output	DC-OK-Signal
Type	spring-clamp terminals	spring-clamp terminals	spring-clamp terminals
Solid wire	0.5-6mm ²	0.5-6mm ²	0.5-6mm ²
Stranded wire	0.5-4mm ²	0.5-4mm ²	0.5-4mm ²
American Wire Gauge	20-10 AWG	20-10 AWG	20-10 AWG
Wire stripping length	10mm / 0.4inch	10mm / 0.4inch	10mm / 0.4inch
Screwdriver	not applicable	not applicable	not applicable
Recommended tightening torque	not applicable	not applicable	not applicable
Pull-out force	10AWG:80N, 12AWG:60N, 14AWG:50N, 16AWG:40N (according to UL486E)		

Instructions:

- a) Use appropriate copper cables that are designed for minimum operating temperatures of:
 - 60°C for ambient up to 45°C and
 - 75°C for ambient up to 60°C minimum
 - 90°C for ambient up to 70°C minimum.
- b) Follow national installation codes and installation regulations!
- c) Ensure that all strands of a stranded wire enter the terminal connection!
- d) Up to two stranded wires with the same cross section are permitted in one connection point (except PE wire).
- e) Do not use the unit without PE connection.
- f) Unused terminal compartments should be securely tightened.
- g) Ferrules are allowed.

Fig. 12-1 Connecting a wire

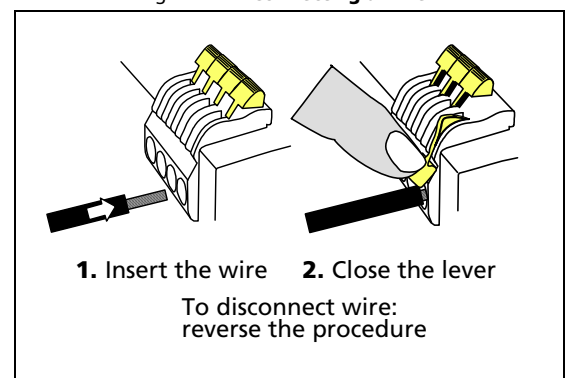

13. FRONT SIDE AND USER ELEMENTS

Fig. 13-1 Front side



- A Input Terminals** (Quick-connect spring-clamp terminals)
 - N, L** Line input
 - \oplus PE (Protective Earth) input

- B Output Terminals** (Quick-connect spring-clamp terminals, two pins per pole)
 - +** Positive output
 - Negative (return) output

- C DC-OK Relay Contact** (Quick-connect spring-clamp terminals)
The DC-OK relay contact is synchronized with the DC-OK LED. See chapter 8 for details.

- D Output voltage potentiometer**
Multi turn potentiometer;
Open the flap to adjust the output voltage. Factory set: 24.1V

- E DC-OK LED** (green)
On, when the output voltage is >90% of the adjusted output voltage

- F Overload LED** (red)
On, when the voltage on the output terminals is <90% of the adjusted output voltage, or in case of a short circuit in the output.
Input voltage is required
Flashing, when the unit has switched off due to over-temperature.

Indicators, LEDs

	Overload LED	DC-OK LED	DC-OK Contact
Normal mode	OFF	ON	Closed
During BonusPower®	OFF	ON	Closed
Overload ($V_{OUT} < 90\%$)	ON	OFF	Open
Output short circuit	ON	OFF	Open
Temperature Shut-down	Intermitted	OFF	Open
No input power	OFF	OFF	Open

14. EMC

The power supply is suitable for applications in industrial environment as well as in residential, commercial and light industry environment without any restrictions.

The CE mark indicates conformance with the EMC directive 2004/108/EC, the low-voltage directive (LVD) 2006/95/EC and the RoHS directive 2011/65/EC. A detailed EMC report is available on request.

EMC Immunity		According generic standards: EN 61000-6-1 and EN 61000-6-2		
Electrostatic discharge	EN 61000-4-2	contact discharge air discharge	8kV 15kV	Criterion A Criterion A
Electromagnetic RF field	EN 61000-4-3	80MHz-2.7GHz	10V/m	Criterion A
Fast transients (Burst)	EN 61000-4-4	input lines output lines DC-OK signal (coupling clamp)	4kV 2kV 1kV	Criterion A Criterion A Criterion A
Surge voltage on input	EN 61000-4-5	L → N L → PE, N → PE	2kV 4kV	Criterion A Criterion A
Surge voltage on output	EN 61000-4-5	+ → - + / - → PE	1kV 1kV	Criterion A Criterion A
Surge voltage on DC-OK	EN 61000-4-5	DC-OK signal → PE	1kV	Criterion A
Conducted disturbance	EN 61000-4-6	0.15-80MHz	10V	Criterion A
Mains voltage dips	EN 61000-4-11	0% of 100Vac 40% of 100Vac 70% of 100Vac 0% of 200Vac 40% of 200Vac 70% of 200Vac	0Vac, 20ms 40Vac, 200ms 70Vac, 500ms 0Vac, 20ms 80Vac, 200ms 140Vac, 500ms	Criterion A Criterion C Criterion A Criterion A Criterion A Criterion A
Voltage interruptions	EN 61000-4-11	0% of 200Vac (=0V)	500ms	Criterion C
Voltage sags	SEMI F47 0706	dips on the input voltage according to SEMI F47 standard 80% of 120Vac (96Vac) 70% of 120Vac (84Vac) 50% of 120Vac (60Vac)	1000ms 500ms 200ms	Criterion A Criterion A Criterion A
Powerful transients	VDE 0160	over entire load range	750V, 1.3ms	Criterion A

Criteria:

- A:** Power supply shows normal operation behavior within the defined limits.
- C:** Temporary loss of function is possible. Power supply may shut-down and restarts by itself. No damage or hazards for the power supply will occur.

EMC Emission		According generic standards: EN 61000-6-3 and EN 61000-6-4	
Conducted emission input lines	EN 55011, EN 55022, FCC Part 15, CISPR 11, CISPR 22	Class B	
Conducted emission output lines **)	IEC/CISPR 16-1-2, IEC/CISPR 16-2-1	limits for DC power port according EN 61000-6-3 fulfilled	
Radiated emission	EN 55011, EN 55022	Class B	
Harmonic input current	EN 61000-3-2	fulfilled for class A equipment	
Voltage fluctuations, flicker	EN 61000-3-3	fulfilled *)	

This device complies with FCC Part 15 rules.

Operation is subjected to following two conditions: (1) this device may not cause harmful interference, and (2) this device must accept any interference received, including interference that may cause undesired operation.

*) tested with constant current loads, non pulsing

**) for information only, not mandatory for EN 61000-6-3

Switching Frequencies	The power supply has three converters with three different switching frequencies included. Two are nearly constant. The other one is input voltage and load dependent.	
Switching frequency 1	35kHz	nearly constant
Switching frequency 2	105kHz	nearly constant
Switching frequency 3	40kHz to 220kHz	input voltage and load dependent

15. ENVIRONMENT

Operational temperature *)	-25°C to +70°C (-13°F to 158°F)	reduce output power according Fig. 15-1
Storage temperature	-40 to +85°C (-40°F to 185°F)	for storage and transportation
Output de-rating	5W/°C	60-70°C (140°F to 158°F)
Humidity **)	5 to 95% r.H.	IEC 60068-2-30
Vibration sinusoidal	2-17.8Hz: ±1.6mm; 17.8-500Hz: 2g 2 hours / axis	IEC 60068-2-6
Shock	30g 6ms, 20g 11ms 3 bumps / direction, 18 bumps in total	IEC 60068-2-27
Altitude	0 to 2000m (0 to 6 560ft) 2000 to 6000m (6 560 to 20 000ft)	without any restrictions reduce output power or ambient temperature, see Fig. 15-2 IEC 62103, EN 50178, overvoltage category II
Altitude de-rating	12W/1000m or 5°C/1000m	> 2000m (6500ft), see Fig. 15-2
Over-voltage category	III II	IEC 62103, EN 50178, altitudes up to 2000m altitudes from 2000m to 6000m
Degree of pollution	2	IEC 62103, EN 50178, not conductive

*) Operational temperature is the same as the ambient temperature and is defined as the air temperature 2cm below the unit.

***) Do not energize while condensation is present

Fig. 15-1 **Output current vs. ambient temp.**

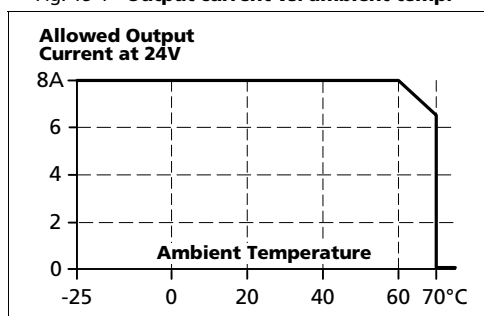
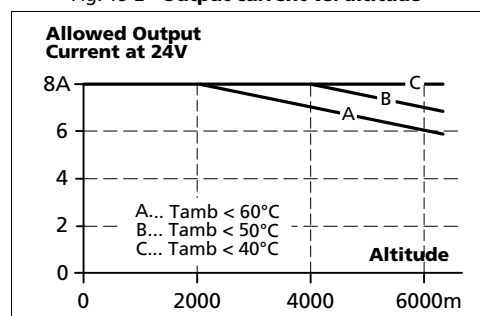

Fig. 15-2 **Output current vs. altitude**



16. PROTECTION FEATURES

Output protection	Electronically protected against overload, no-load and short-circuits *)	
Output over-voltage protection	typ. 27Vdc max. 29.5Vdc	In case of an internal power supply defect, a redundant circuit limits the maximum output voltage. The output shuts down and automatically attempts to restart.
Degree of protection	IP 20	EN/IEC 60529
Penetration protection	> 3.5mm	e.g. screws, small parts
Over-temperature protection	yes	Output shut-down with automatic restart
Input transient protection	MOV (Metal Oxide Varistor)	
Internal input fuse	T6.3A H.B.C.	not user replaceable

*) In case of a protection event, audible noise may occur.

17. SAFETY FEATURES

Input / output separation *)	SELV PELV double or reinforced insulation	IEC/EN 60950-1 IEC/EN 60204-1, EN 50178, IEC 62103, IEC 60364-4-41
Class of protection	I	PE (Protective Earth) connection required
Isolation resistance	> 5MΩ	input to output, 500Vdc
PE resistance	< 0.1Ω	
Touch current (leakage current)	typ. 0.19mA / 0.44mA typ. 0.29mA / 0.65mA typ. 0.53mA / 1.04mA < 0.25mA / 0.54mA < 0.38mA / 0.79mA < 0.74mA / 1.29mA	100Vac, 50Hz, TN-,TT-mains / IT-mains 120Vac, 60Hz, TN-,TT-mains / IT-mains 230Vac, 50Hz, TN-,TT-mains / IT-mains 110Vac, 50Hz, TN-,TT-mains / IT-mains 132Vac, 60Hz, TN-,TT-mains / IT-mains 264Vac, 50Hz, TN-,TT-mains / IT-mains

*) double or reinforced insulation

18. DIELECTRIC STRENGTH

The output voltage is floating and has no ohmic connection to the ground. Type and factory tests are conducted by the manufacturer. Field tests may be conducted in the field using the appropriate test equipment which applies the voltage with a slow ramp (2s up and 2s down). Connect all input-terminals together as well as all output poles before conducting the test. When testing, set the cut-off current settings to the value in the table below.

Fig. 18-1 Dielectric strength

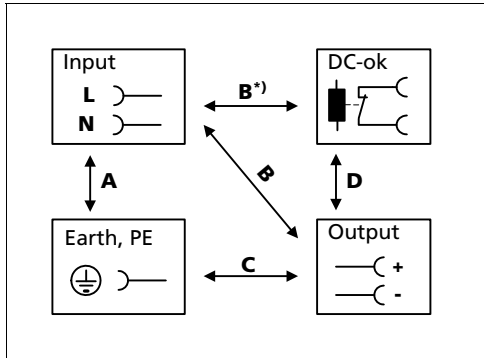

		A	B	C	D
Type test	60s	2500Vac	3000Vac	500Vac	500Vac
Factory test	5s	2500Vac	2500Vac	500Vac	500Vac
Field test	5s	2000Vac	2000Vac	500Vac	500Vac
Cut-off current setting		> 10mA	> 10mA	> 20mA	> 1mA

To fulfil the PELV requirements according to EN60204-1 § 6.4.1, we recommend that either the + pole, the – pole or any other part of the output circuit shall be connected to the protective earth system. This helps to avoid situations in which a load starts unexpectedly or can not be switched off when unnoticed earth faults occur.

B*) When testing input to DC-OK ensure that the max. voltage between DC-OK and the output is not exceeded (column D). We recommend connecting DC-OK pins and the output pins together when performing the test.

19. APPROVALS

EC Declaration of Conformity		The CE mark indicates conformance with the EMC directive 2004/108/EC, the low-voltage directive (LVD) 2006/95/EC and the RoHS directive 2011/65/EC.
DeviceNet®		DeviceNet conformance tested by the Open DeviceNet® Vendor Organization.
IEC 60950-1 2 nd Edition		CB Scheme, Information Technology Equipment
UL 508		Listed for use as Industrial Control Equipment; U.S.A. (UL 508) and Canada (C22.2 No. 107-1-01); E-File: E198865
UL 60950-1 2 nd Edition		Recognized for use as Information Technology Equipment, Level 5; U.S.A. (UL 60950-1) and Canada (C22.2 No. 60950-1); E-File: E137006
ANSI / ISA 12.12.01-2007 (Class I Div 2)		Recognized for use in Hazardous Location Class I Div 2 T4 Groups A,B,C,D systems; U.S.A. (ANSI / ISA 12.12.01-2007) and Canada (C22.2 No. 213-M1987) The unit is suitable for use in Class I Division 2 Groups A, B, C, D locations. Substitution of components may impair suitability for Class I Division 2 environment. Do not disconnect equipment unless power has been switched off. Wiring must be in accordance with Class I, Division 2 wiring methods of the National Electrical Code, NFPA 70, and in accordance with other local or national codes.
Marine		GL (Germanischer Lloyd) classified and ABS (American Bureau for Shipping) PDA Environmental category: C, EMC2 Marine and offshore applications
SEMI F47		SEMI F47-0706 Ride-through compliance for semiconductor industry. Full SEMI range compliance (Input: AC120V or higher, output: < 192W)

20. PHYSICAL DIMENSIONS AND WEIGHT

Weight	900g / 1.98lb
DIN-Rail	Use 35mm DIN-rails according to EN 60715 or EN 50022 with a height of 7.5 or 15mm. The DIN-rail height must be added to the unit depth (117mm) to calculate the total required installation depth.
Installation Clearances	See chapter 2

Fig. 20-1 **Front view**

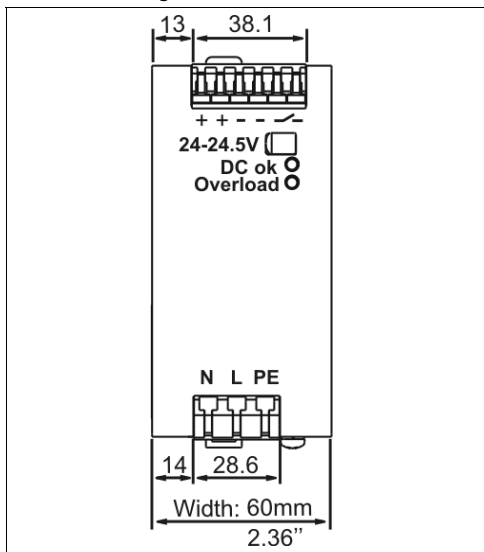
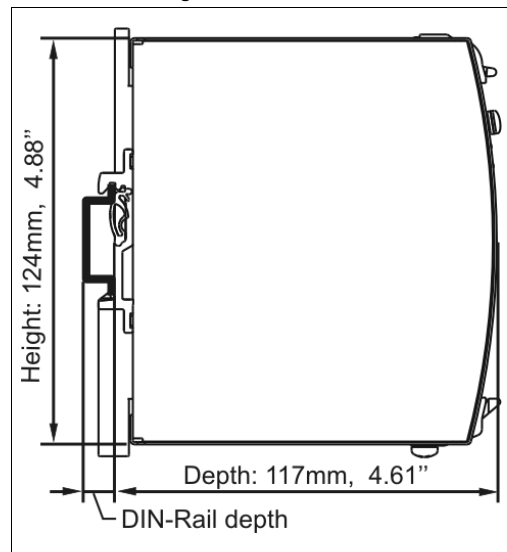

Fig. 20-2 **Side view**



21. ACCESSORIES

21.1. ZM1.WALL WALL MOUNTING BRACKET

This bracket is used to mount the power supply onto a flat surface without utilizing a DIN-Rail.

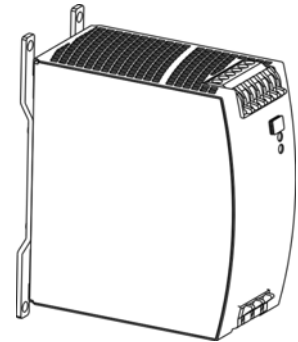
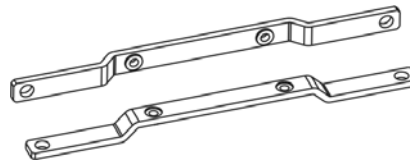

21.2. ZM13.SIDE SIDE MOUNTING BRACKET

This bracket is used to mount Dimension units sideways with or without utilizing a DIN-Rail. The two aluminum brackets and the black plastic slider of the unit have to be detached, so that the steel brackets can be mounted.

For sideways DIN-rail mounting, the removed aluminum brackets and the black plastic slider need to be mounted on the steel bracket.

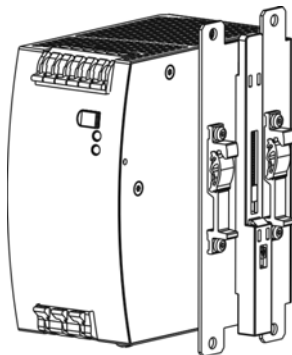

Side mounting with DIN-rail brackets

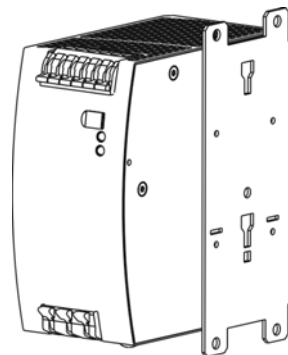

Side mounting without DIN-rail brackets

21.3. UF20.241 BUFFER MODULE

This buffer unit is a supplementary device for DC 24V power supplies. It delivers power to bridge typical mains failures or extends the hold-up time after turn-off of the AC power. In times when the power supply provides sufficient voltages, the buffer unit stores energy in integrated electrolytic capacitors. In case of mains voltage fault, this energy is released again in a regulated process. One buffer module can deliver 20A additional current.

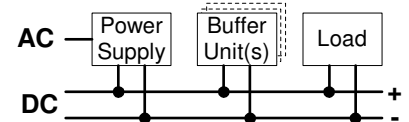

The buffer unit does not require any control wiring. It can be added in parallel to the load circuit at any given point. Buffer units can be added in parallel to increase the output ampacity or the hold-up time.

22. APPLICATION NOTES

22.1. PEAK CURRENT CAPABILITY

Solenoids, contactors and pneumatic modules often have a steady state coil and a pick-up coil. The inrush current demand of the pick-up coil is several times higher than the steady-state current and usually exceeds the nominal output current (including the PowerBoost). The same situation applies when starting a capacitive load.

Branch circuits are often protected with circuit breakers or fuses. In case of a short or an overload in the branch circuit, the fuse needs a certain amount of over-current to trip or to blow. The peak current capability ensures the safe operation of subsequent circuit breakers.

Assuming the input voltage is turned on before such an event, the built-in large sized output capacitors inside the power supply can deliver extra current. Discharging this capacitor causes a voltage dip on the output. The following two examples show typical voltage dips:

Fig. 22-1 **Peak load with 2x the nominal current for 50ms, typ.**

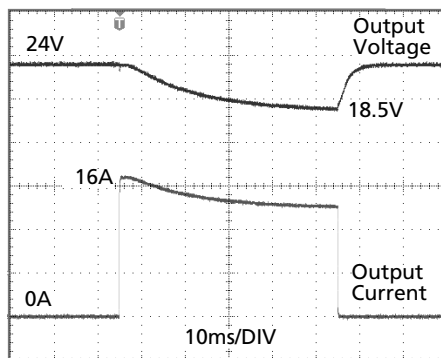

Peak load 16A (resistive) for 50ms
Output voltage dips from 24V to 18.5V.

Fig. 22-2 **Peak load with 4x the nominal current for 5ms, typ.**

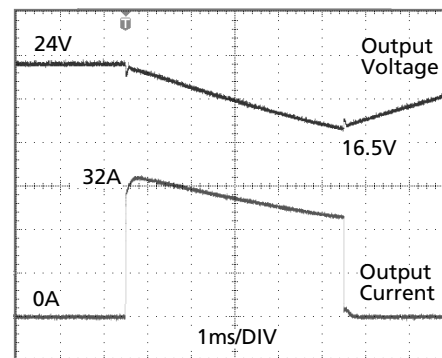

Peak load 32A (resistive) for 5ms
Output voltage dips from 24V to 16.5V.

Please note: The DC-OK relay triggers when the voltage dips more than 10% for longer than 1ms.

22.2. BACK-FEEDING LOADS

Loads such as decelerating motors and inductors can feed voltage back to the power supply. This feature is also called return voltage immunity or resistance against Back- E.M.F. (Electro Magnetic Force).

This power supply is resistant and does not show malfunctioning when a load feeds back voltage to the power supply. It does not matter whether the power supply is on or off.

The maximum allowed feed-back-voltage is 35Vdc. The absorbing energy can be calculated according to the built-in large sized output capacitor which is specified in chapter 6.

22.3. EXTERNAL INPUT PROTECTION

The unit is tested and approved for branch circuits up to 20A. An external protection is only required if the supplying branch has an ampacity greater than this. Check also local codes and local requirements. In some countries local regulations might apply.

If an external fuse is necessary or utilized, minimum requirements need to be considered to avoid nuisance tripping of the circuit breaker. A minimum value of 6A B- or 4A C-Characteristic breaker should be used

22.4. CHARGING OF BATTERIES

The power supply can not be used to charge any kind of batteries since the output voltage adjustment range is too small.

22.5. OUTPUT CIRCUIT BREAKERS

Standard miniature circuit breakers (MCB's or UL1077 circuit breakers) are commonly used for AC-supply systems and may also be used on 24V branches.

MCB's are designed to protect wires and circuits. If the ampere value and the characteristics of the MCB are adapted to the wire size that is used, the wiring is considered as thermally safe regardless of whether the MCB opens or not.

To avoid voltage dips and under-voltage situations in adjacent 24V branches which are supplied by the same source, a fast (magnetic) tripping of the MCB is desired. A quick shutdown within 10ms is necessary corresponding roughly to the ride-through time of PLC's. This requires power supplies with high current reserves and large output capacitors. Furthermore, the impedance of the faulty branch must be sufficiently small in order for the current to actually flow. The best current reserve in the power supply does not help if Ohm's law does not permit current flow. The following table has typical test results showing which B- and C-Characteristic MCBs magnetically trip depending on the wire cross section and wire length.

Fig. 22-3 Test circuit

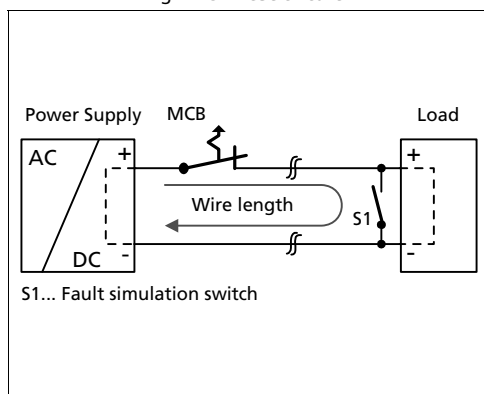

Maximal wire length*) for a fast (magnetic) tripping:

	0.75mm ²	1.0mm ²	1.5mm ²	2.5mm ²
C-2A	23m	29m	48m	69m
C-3A	20m	24m	38m	57m
C-4A	12m	16m	22m	33m
C-6A	5m	7m	9m	14m
C-8A	3m	4m	5m	7m
C-10A	2m	3m	4m	6m
C-13A	1m	1m	2m	2m
B-6A	11mm	14m	24m	34m
B-10A	5m	8m	11m	18m
B-13A	4m	6m	8m	10m

*) Don't forget to consider twice the distance to the load (or cable length) when calculating the total wire length (+ and - wire).

22.6. PARALLEL USE TO INCREASE OUTPUT POWER

Do not use power supplies in parallel since the DeviceNet® cable is rated only up to 8A and could be overheated.

22.7. PARALLEL USE FOR REDUNDANCY

Do not use power supplies in a standard 1+1 redundancy configuration since the DeviceNet® cable is rated only up to 8A. In a failure mode (short-circuit on the load) 16A could flow into the DeviceNet® cable.

22.8. SERIES OPERATION

Use the standard QS10.241 power supply when units need to be connected in series for higher load voltages.

22.9. INDUCTIVE AND CAPACITIVE LOADS

The unit is designed to supply any kind of loads, including unlimited capacitive and inductive loads.

22.10. OPERATION ON TWO PHASES

The power supply can also be used on two-phases of a three-phase-system. Such a phase-to-phase connection is allowed as long as the supplying voltage is below 240V+15%. Use a fuse or a circuit breaker to protect the N input. The N input is internally not protected and is in this case connected to a hot wire. Appropriate fuses or circuit breakers are specified in section 22.3 "External Input Protection".

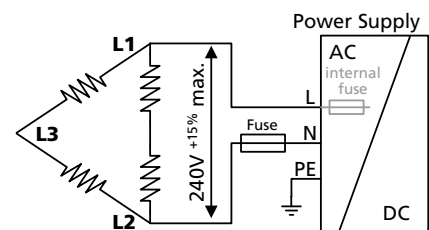

22.11. USE IN A TIGHTLY SEALED ENCLOSURE

When the power supply is installed in a tightly sealed enclosure, the temperature inside the enclosure will be higher than outside. In such situations, the inside temperature defines the ambient temperature for the power supply.

The following measurement results can be used as a reference to estimate the temperature rise inside the enclosure.

The power supply is placed in the middle of the box, no other heat producing items are inside the box

Enclosure:	Rittal Typ IP66 Box PK 9519 100, plastic, 180x180x165mm
Load:	24V, 6.4A; (=80%) load is placed outside the box
Input:	230Vac
Temperature inside enclosure:	44.0°C (in the middle of the right side of the power supply with a distance of 2cm)
Temperature outside enclosure:	26.8°C
Temperature rise:	17.2K

Mounting Orientations

Mounting orientations other than input terminals on the bottom and output on the top require a reduction in continuous output power or a limitation in the maximum allowed ambient temperature. The amount of reduction influences the lifetime expectancy of the power supply. Therefore, two different derating curves for continuous operation can be found below:

Curve A1 Recommended output current.

Curve A2 Max allowed output current (results in approximately half the lifetime expectancy of A1).

Fig. 22-4
Mounting Orientation A
(Standard orientation)

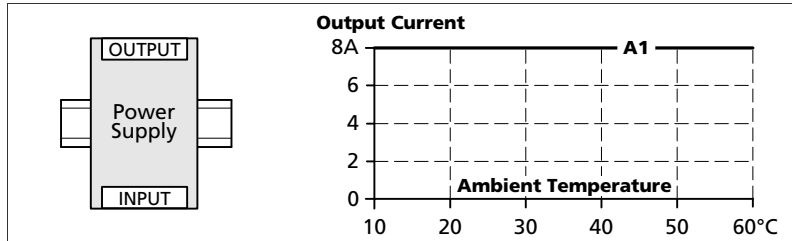

Fig. 22-5
Mounting Orientation B
(Upside down)

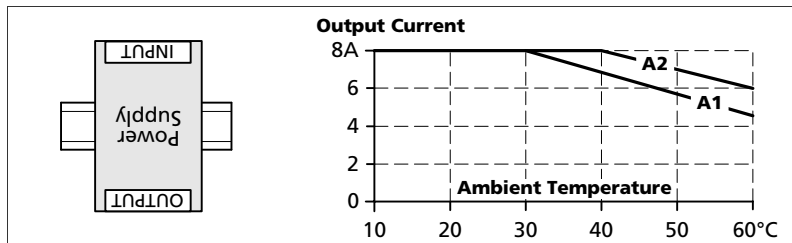

Fig. 22-6
Mounting Orientation C
(Table-top mounting)

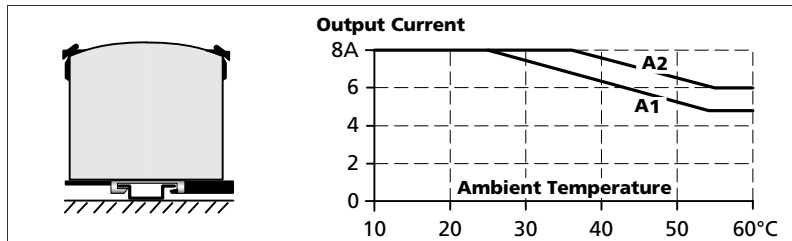

Fig. 22-7
Mounting Orientation D
(Horizontal cw)

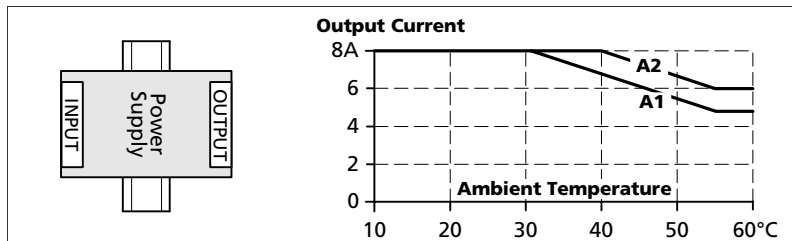

Fig. 22-8
Mounting Orientation E
(Horizontal ccw)

