



Chipsmall Limited consists of a professional team with an average of over 10 year of expertise in the distribution of electronic components. Based in Hongkong, we have already established firm and mutual-benefit business relationships with customers from,Europe,America and south Asia,supplying obsolete and hard-to-find components to meet their specific needs.

With the principle of "Quality Parts,Customers Priority,Honest Operation,and Considerate Service",our business mainly focus on the distribution of electronic components. Line cards we deal with include Microchip,ALPS,ROHM,Xilinx,Pulse,ON,Everlight and Freescale. Main products comprise IC,Modules,Potentiometer,IC Socket,Relay,Connector.Our parts cover such applications as commercial,industrial, and automotives areas.

We are looking forward to setting up business relationship with you and hope to provide you with the best service and solution. Let us make a better world for our industry!



Contact us

Tel: +86-755-8981 8866 Fax: +86-755-8427 6832

Email & Skype: info@chipsmall.com Web: www.chipsmall.com

Address: A1208, Overseas Decoration Building, #122 Zhenhua RD., Futian, Shenzhen, China



V_{DSS}	-30V
$R_{DS(on)}(Max.)$	39mΩ
I_D	±5A
P_D	1.5W

●Features

- 1) Low on - resistance.
- 2) Built-in G-S protection diode.
- 3) Small surface mount package(TSMT8)
- 4) Pb-free lead plating ; RoHS compliant

●Application

Switching

●Outline

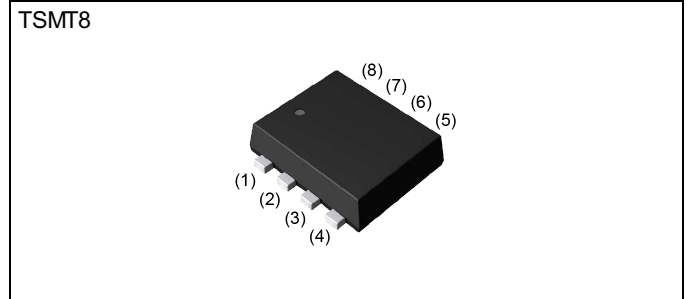

●Inner circuit

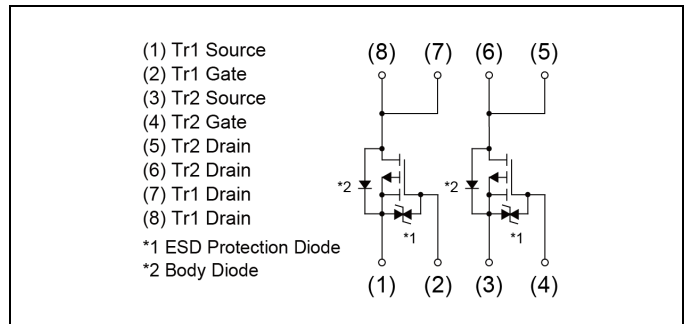

●Packaging specifications

Type	Packing	Embossed Tape
	Reel size (mm)	180
Tape width (mm)	8	
Basic ordering unit (pcs)	3000	
Taping code	TR	
Marking	J05	

●Absolute maximum ratings ($T_a = 25^{\circ}C$) <It is the same ratings for the Tr1 and Tr2>

Parameter	Symbol	Value	Unit
Drain - Source voltage	V_{DSS}	-30	V
Continuous drain current	I_D	±5	A
Pulsed drain current	$I_{D,pulse}^{*1}$	±20	A
Gate - Source voltage	V_{GSS}	±20	V
Power dissipation	total	P_D^{*2}	1.5
	element		1.25
	total	P_D^{*3}	0.7
Junction temperature	T_j	150	°C
Range of storage temperature	T_{stg}	-55 to +150	°C

● Thermal resistance

Parameter	Symbol	Values			Unit	
		Min.	Typ.	Max.		
Thermal resistance, junction - ambient	total	R_{thJA}^{*2}	-	-	83.3	°C/W
	element		-	-	100	
	total	R_{thJA}^{*3}	-	-	178	

● Electrical characteristics ($T_a = 25^{\circ}C$) <It is the same characteristics for the Tr1 and Tr2>

Parameter	Symbol	Conditions	Values			Unit
			Min.	Typ.	Max.	
Drain - Source breakdown voltage	$V_{(BR)DSS}$	$V_{GS} = 0V, I_D = -1mA$	-30	-	-	V
Breakdown voltage temperature coefficient	$\frac{\Delta V_{(BR)DSS}}{\Delta T_j}$	$I_D = -1mA$ referenced to 25°C	-	-24.1	-	mV/°C
Zero gate voltage drain current	I_{DSS}	$V_{DS} = -30V, V_{GS} = 0V$	-	-	-1	μA
Gate - Source leakage current	I_{GSS}	$V_{DS} = 0V, V_{GS} = \pm 20V$	-	-	±10	μA
Gate threshold voltage	$V_{GS(th)}$	$V_{DS} = -10V, I_D = -1mA$	-1.0	-	-2.5	V
Gate threshold voltage temperature coefficient	$\frac{\Delta V_{GS(th)}}{\Delta T_j}$	$I_D = -1mA$ referenced to 25°C	-	3.3	-	mV/°C
Static drain - source on - state resistance	$R_{DS(on)}^{*4}$	$V_{GS} = -10V, I_D = -5A$	-	28	39	mΩ
		$V_{GS} = -4.5V, I_D = -2.5A$	-	40	56	
		$V_{GS} = -4V, I_D = -2.5A$	-	45	63	
Gate input resistance	R_G	f = 1MHz, open drain	-	15	-	Ω
Forward Transfer Admittance	$ Y_{fs} ^{*4}$	$V_{DS} = -10V, I_D = -5A$	3	-	-	S

● **Electrical characteristics** ($T_a = 25^\circ\text{C}$) <It is the same characteristics for the Tr1 and Tr2>

Parameter	Symbol	Conditions	Values			Unit
			Min.	Typ.	Max.	
Input capacitance	C_{iss}	$V_{GS} = 0V$	-	1100	-	pF
Output capacitance	C_{oss}	$V_{DS} = -10V$	-	150	-	
Reverse transfer capacitance	C_{rss}	$f = 1\text{MHz}$	-	130	-	
Turn - on delay time	$t_{d(on)}^{*4}$	$V_{DD} \approx -15V, V_{GS} = -10V$	-	9	-	ns
Rise time	t_r^{*4}	$I_D = -2.5A$	-	40	-	
Turn - off delay time	$t_{d(off)}^{*4}$	$R_L = 6\Omega$	-	90	-	
Fall time	t_f^{*4}	$R_G = 10\Omega$	-	55	-	

● **Gate charge characteristics** ($T_a = 25^\circ\text{C}$) <It is the same characteristics for the Tr1 and Tr2>

Parameter	Symbol	Conditions	Values			Unit	
			Min.	Typ.	Max.		
Total gate charge	Q_g^{*4}	$V_{DD} \approx -15V$ $I_D = -5A$	$V_{GS} = -10V$	-	19	-	nC
Gate - Source charge	Q_{gs}^{*4}		$V_{GS} = -5V$	-	10.0	-	
Gate - Drain charge	Q_{gd}^{*4}			-	3.0	-	

● **Body diode electrical characteristics** (Source-Drain) ($T_a = 25^\circ\text{C}$)

<It is the same characteristics for the Tr1 and Tr2>

Parameter	Symbol	Conditions	Values			Unit
			Min.	Typ.	Max.	
Body diode continuous forward current	I_S	$T_a = 25^\circ\text{C}$	-	-	-1	A
Body diode pulse current	I_{SP}^{*1}		-	-	-20	
Forward voltage	V_{SD}^{*4}	$V_{GS} = 0V, I_S = -5A$	-	-	-1.2	V

*1 $P_w \leq 10\mu\text{s}$, Duty cycle $\leq 1\%$

*2 Mounted on a ceramic board (30×30×0.8mm)

*3 Mounted on a FR4 (20×20×0.8mm)

*4 Pulsed

● Electrical characteristic curves

Fig.1 Power Dissipation Derating Curve

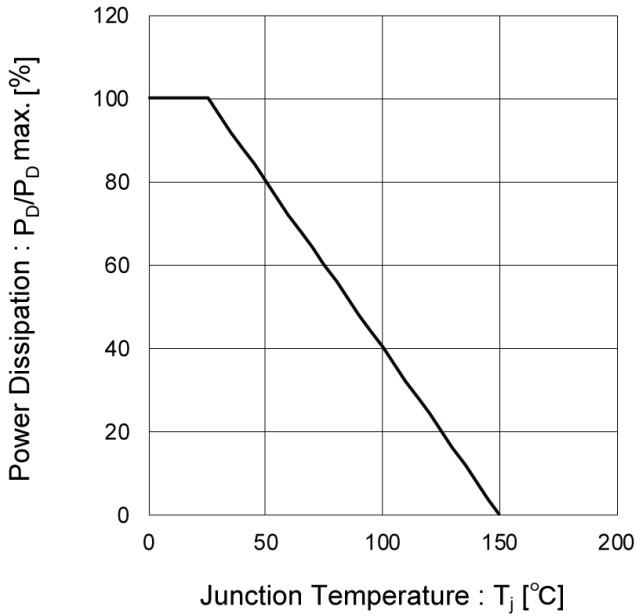

Fig.2 Maximum Safe Operating Area

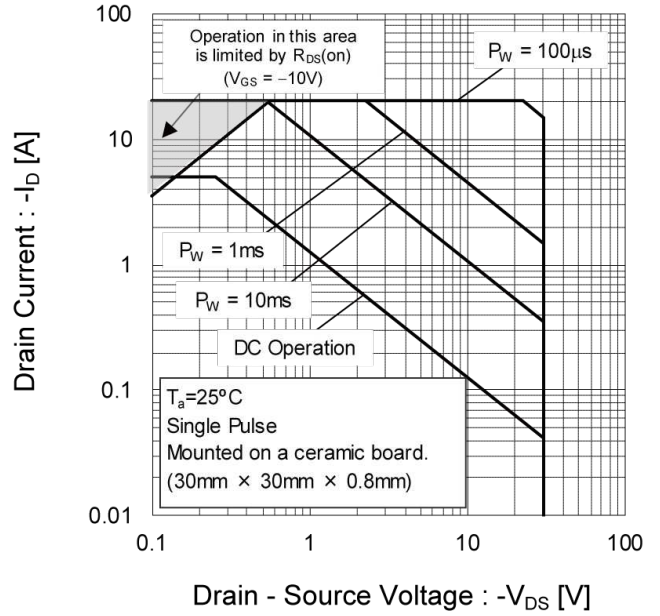

Fig.3 Normalized Transient Thermal Resistance vs. Pulse Width

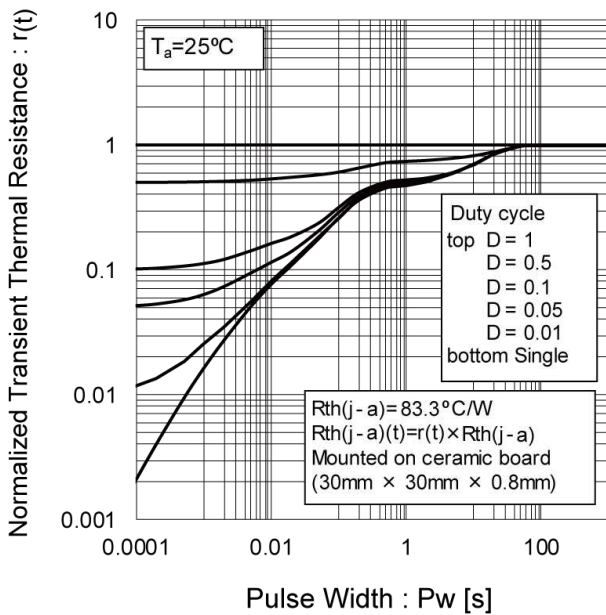
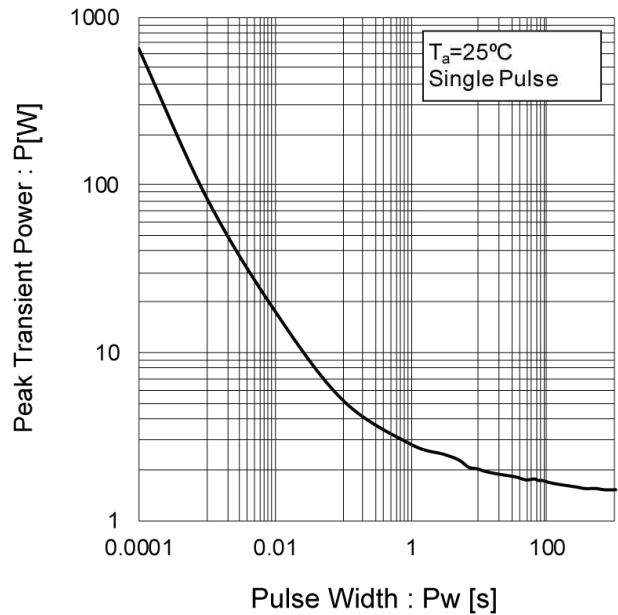

Fig.4 Single Pulse Maximum Power dissipation



● Electrical characteristic curves

Fig.5 Typical Output Characteristics(I)

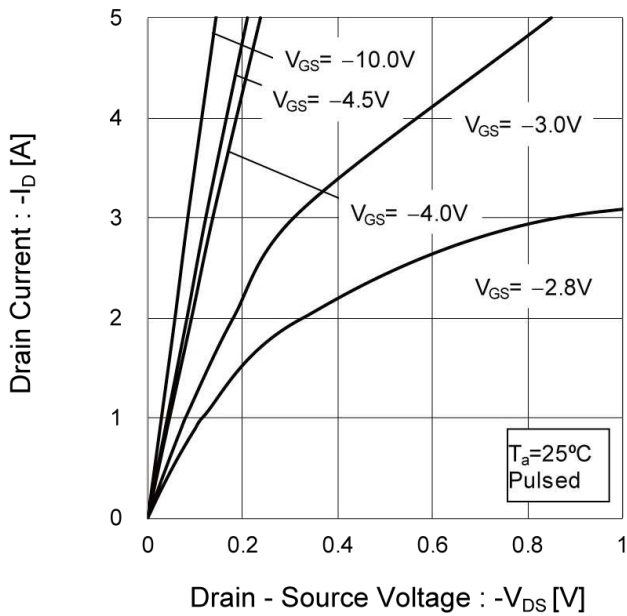

Fig.6 Typical Output Characteristics(II)

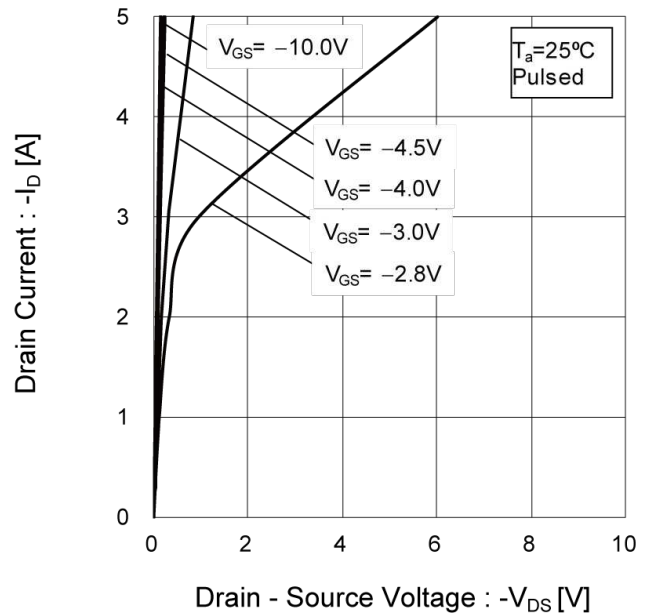

Fig.7 Breakdown Voltage vs. Junction Temperature

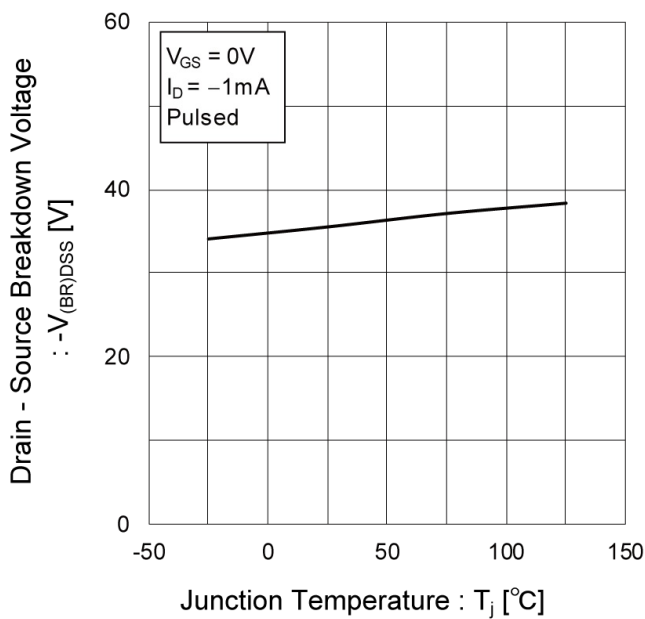
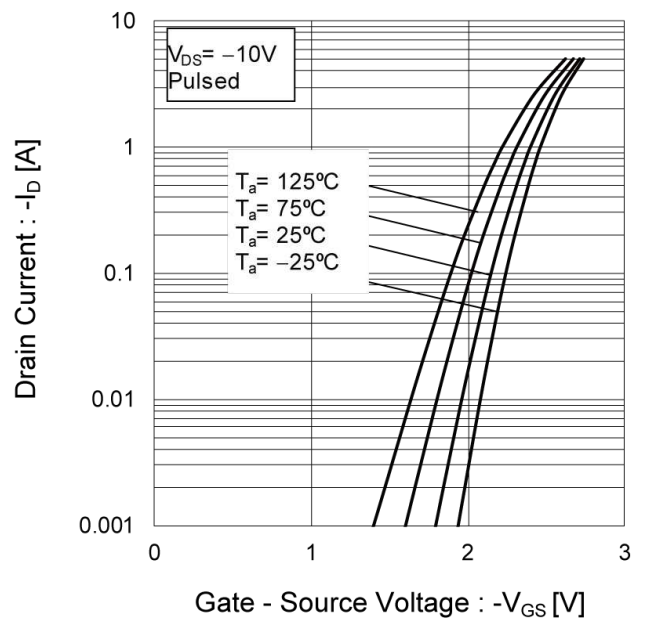

Fig.8 Typical Transfer Characteristics



●Electrical characteristic curves

Fig.9 Gate Threshold Voltage vs. Junction Temperature

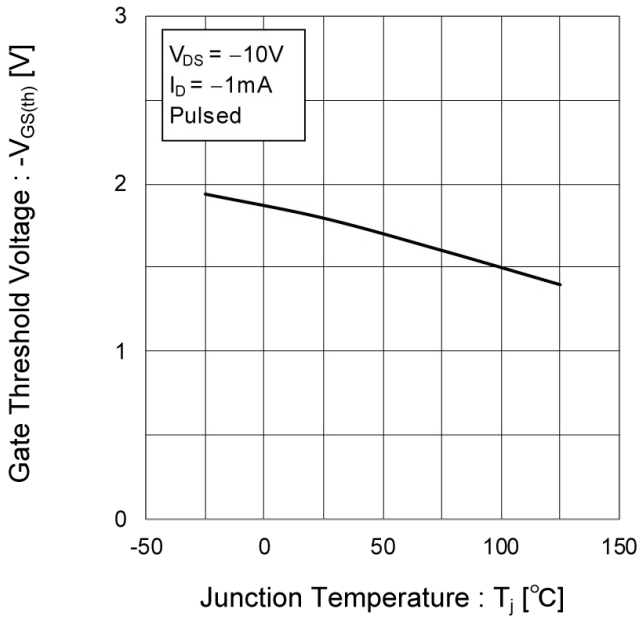

Fig.10 Forward Transfer Admittance vs. Drain Current

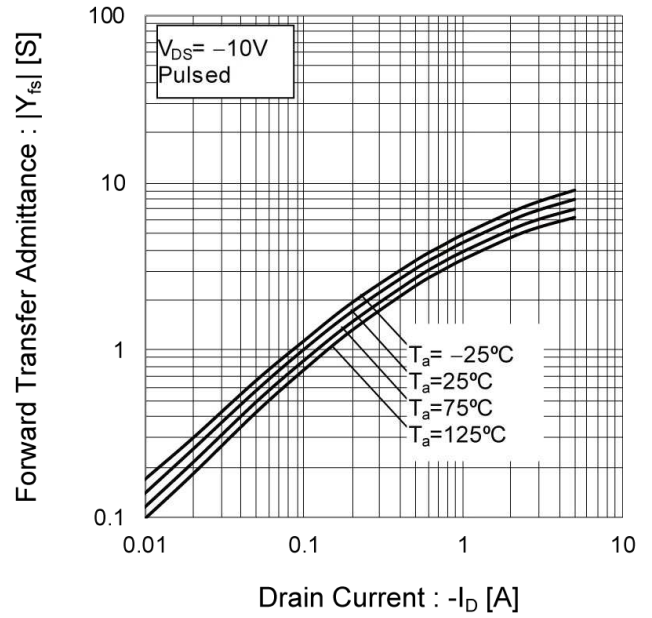

Fig.11 Drain Current Derating Curve

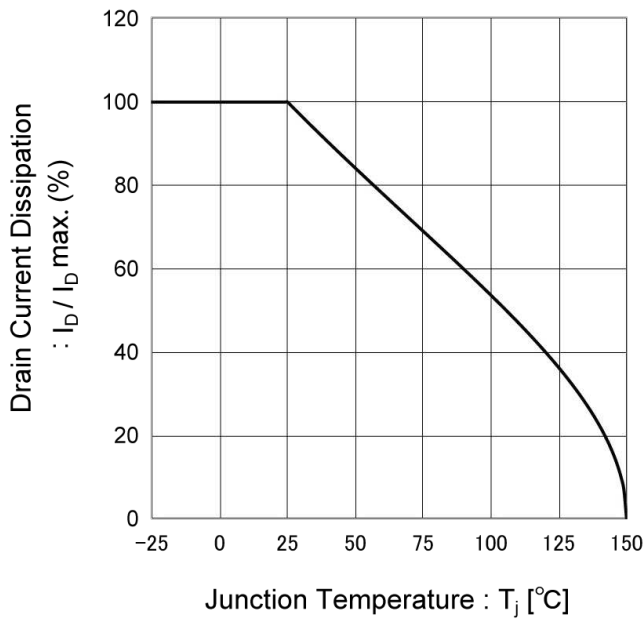
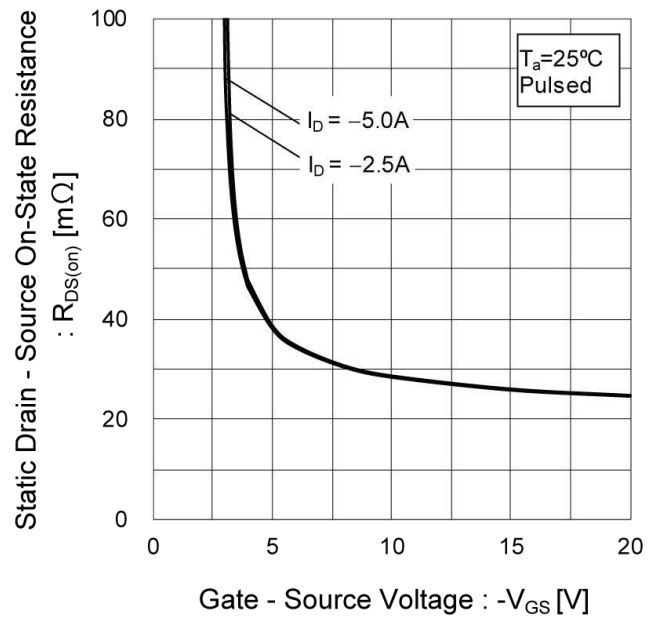

Fig.12 Static Drain - Source On - State Resistance vs. Gate Source Voltage



● Electrical characteristic curves

Fig.13 Static Drain - Source On - State Resistance vs. Junction Temperature

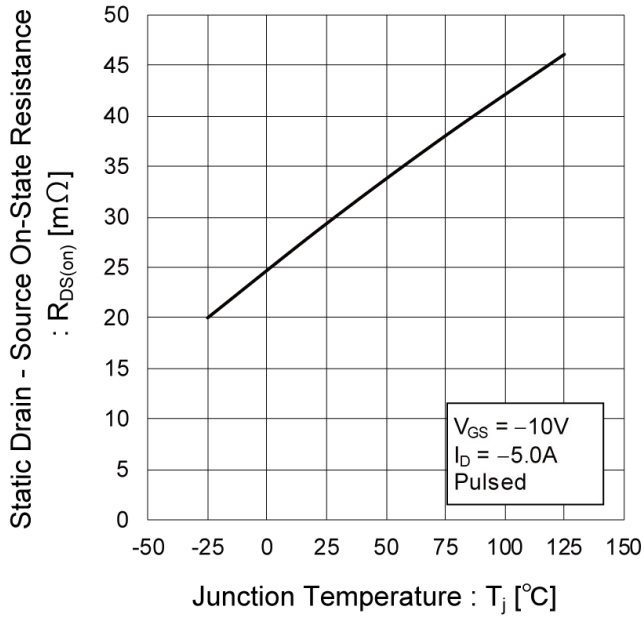
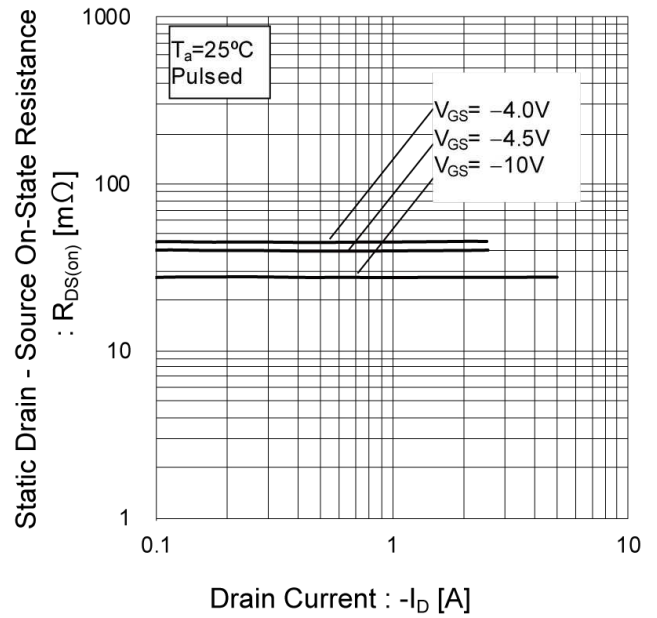

Fig.14 Static Drain - Source On - State Resistance vs. Drain Current (I)



● Electrical characteristic curves

Fig.15 Static Drain - Source On - State Resistance vs. Drain Current (II)

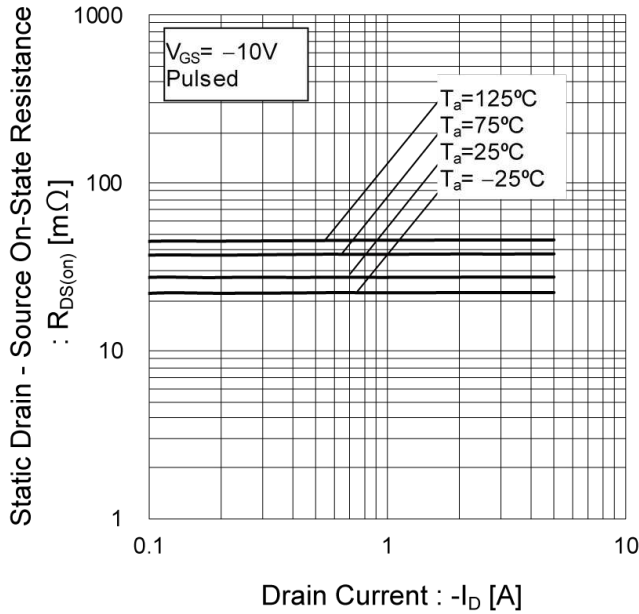

Fig.16 Static Drain - Source On - State Resistance vs. Drain Current (III)

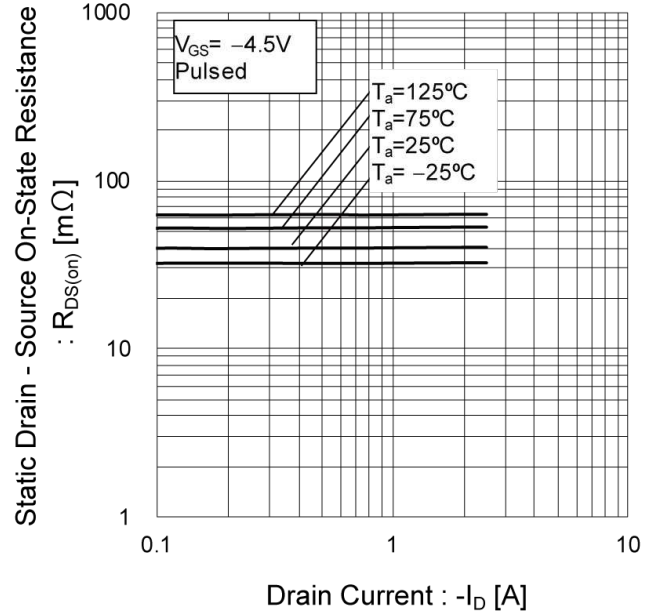
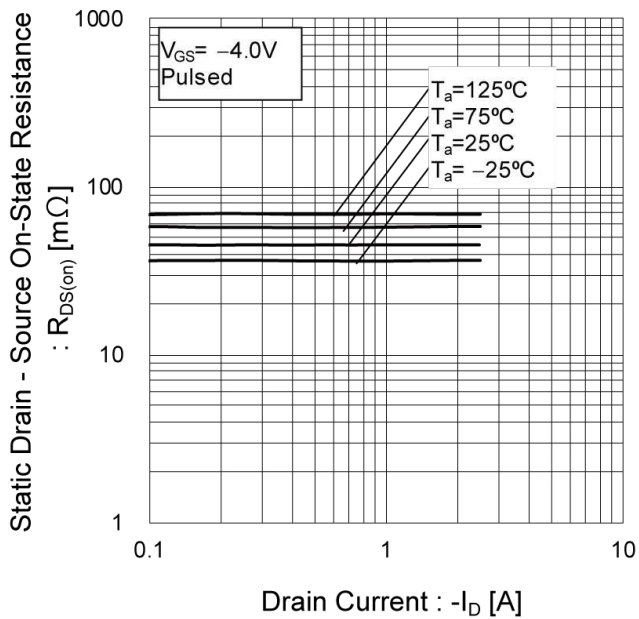

Fig.17 Static Drain - Source On - State Resistance vs. Drain Current (IV)



●Electrical characteristic curves

Fig.18 Typical Capacitance vs. Drain - Source Voltage

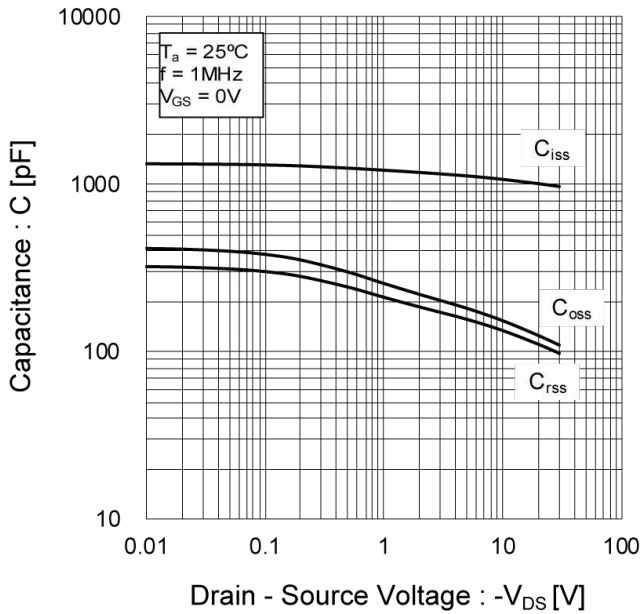

Fig.19 Switching Characteristics

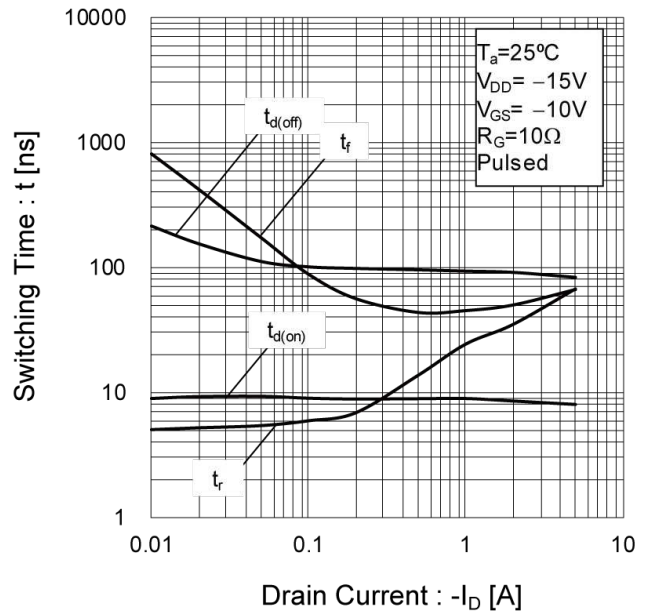

Fig.20 Dynamic Input Characteristics

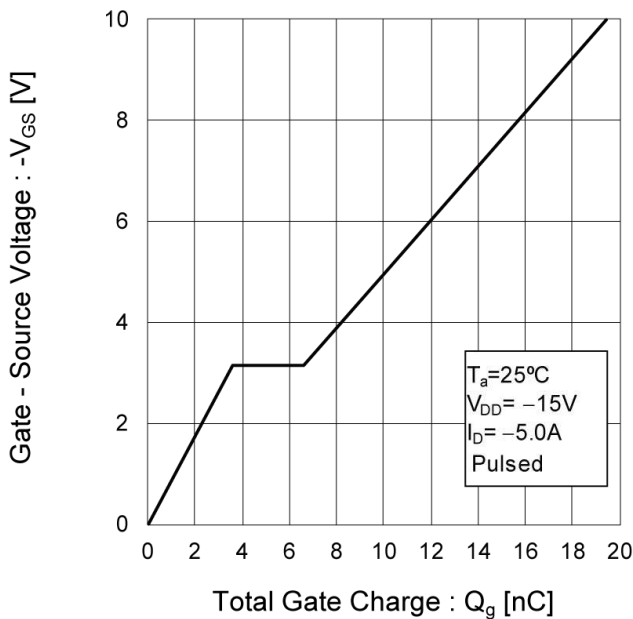
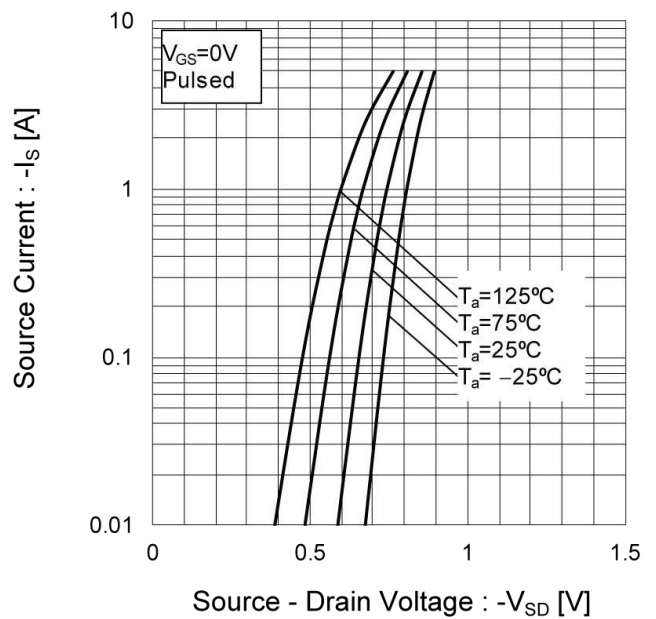

Fig.21 Source Current vs. Source Drain Voltage



● Measurement circuits <It is the same for the Tr1 and Tr2>

Fig. 1-1 SWITCHING TIME MEASUREMENT CIRCUIT

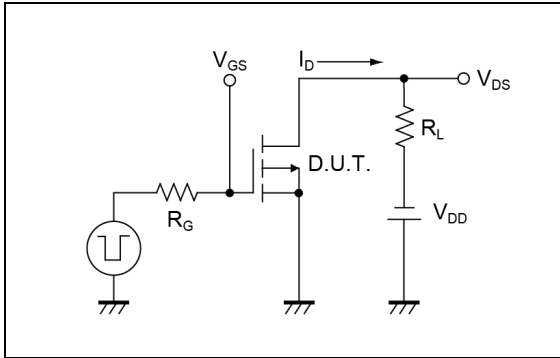

Fig. 1-2 SWITCHING WAVEFORMS

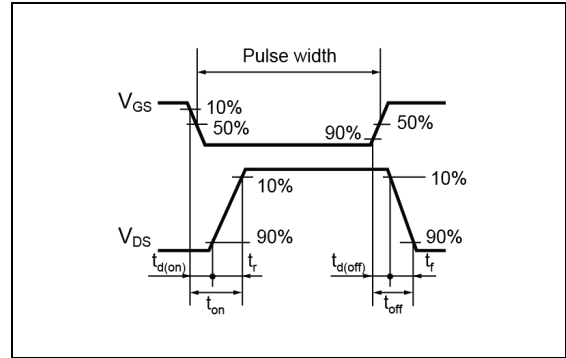

Fig. 2-1 GATE CHARGE MEASUREMENT CIRCUIT

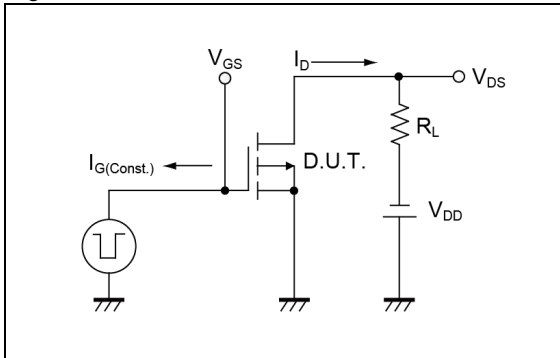
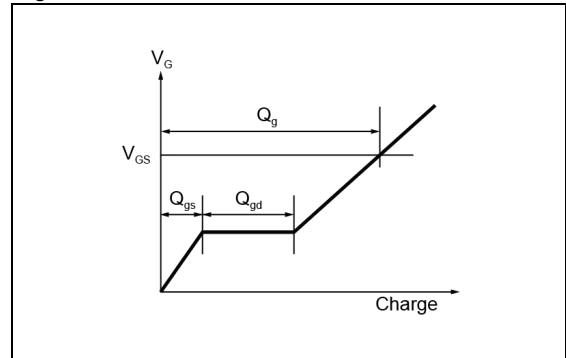
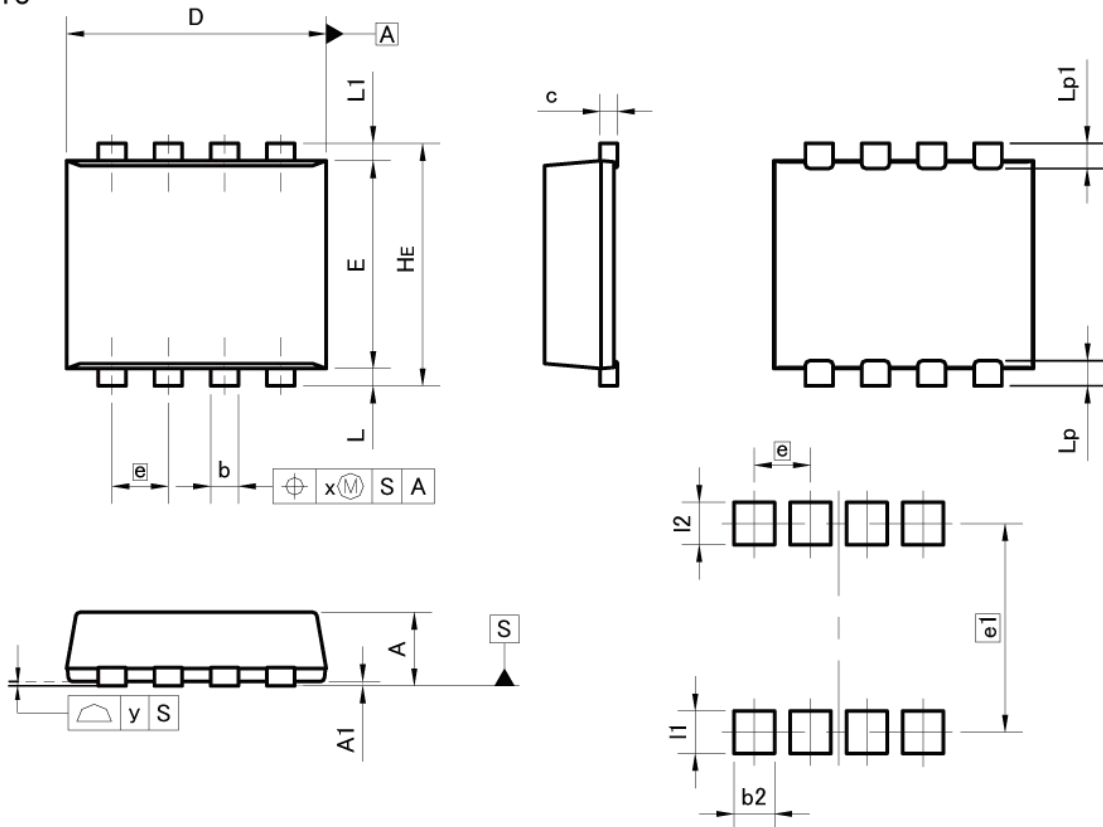

Fig. 2-2 GATE CHARGE WAVEFORM



●Dimensions

TSMT8



Pattern of terminal position areas
[Not a pattern of soldering pads]

DIM	MILIMETERS		INCHES	
	MIN	MAX	MIN	MAX
A	0.75	0.85	0.030	0.033
A1	0.00	0.05	0.000	0.002
b	0.27	0.37	0.011	0.015
c	0.12	0.22	0.005	0.009
D	2.90	3.10	0.114	0.122
E	2.30	2.50	0.091	0.098
e	0.65		0.026	
HE	2.70	2.90	0.106	0.114
L	0.10	0.30	0.004	0.012
L1	0.10	0.30	0.004	0.012
Lp	0.19	0.39	0.007	0.015
Lp1	0.19	0.39	0.007	0.015
x	-	0.10	-	0.004
y	-	0.10	-	0.004

DIM	MILIMETERS		INCHES	
	MIN	MAX	MIN	MAX
b2	-	0.47	-	0.019
e1	2.41		0.095	
I1	-	0.49	-	0.019
I2	-	0.49	-	0.019

Dimension in mm/inches

Notes

- 1) The information contained herein is subject to change without notice.
- 2) Before you use our Products, please contact our sales representative and verify the latest specifications :
- 3) Although ROHM is continuously working to improve product reliability and quality, semiconductors can break down and malfunction due to various factors. Therefore, in order to prevent personal injury or fire arising from failure, please take safety measures such as complying with the derating characteristics, implementing redundant and fire prevention designs, and utilizing backups and fail-safe procedures. ROHM shall have no responsibility for any damages arising out of the use of our Products beyond the rating specified by ROHM.
- 4) Examples of application circuits, circuit constants and any other information contained herein are provided only to illustrate the standard usage and operations of the Products. The peripheral conditions must be taken into account when designing circuits for mass production.
- 5) The technical information specified herein is intended only to show the typical functions of and examples of application circuits for the Products. ROHM does not grant you, explicitly or implicitly, any license to use or exercise intellectual property or other rights held by ROHM or any other parties. ROHM shall have no responsibility whatsoever for any dispute arising out of the use of such technical information.
- 6) The Products are intended for use in general electronic equipment (i.e. AV/OA devices, communication, consumer systems, gaming/entertainment sets) as well as the applications indicated in this document.
- 7) The Products specified in this document are not designed to be radiation tolerant.
- 8) For use of our Products in applications requiring a high degree of reliability (as exemplified below), please contact and consult with a ROHM representative : transportation equipment (i.e. cars, ships, trains), primary communication equipment, traffic lights, fire/crime prevention, safety equipment, medical systems, servers, solar cells, and power transmission systems.
- 9) Do not use our Products in applications requiring extremely high reliability, such as aerospace equipment, nuclear power control systems, and submarine repeaters.
- 10) ROHM shall have no responsibility for any damages or injury arising from non-compliance with the recommended usage conditions and specifications contained herein.
- 11) ROHM has used reasonable care to ensure the accuracy of the information contained in this document. However, ROHM does not warrant that such information is error-free, and ROHM shall have no responsibility for any damages arising from any inaccuracy or misprint of such information.
- 12) Please use the Products in accordance with any applicable environmental laws and regulations, such as the RoHS Directive. For more details, including RoHS compatibility, please contact a ROHM sales office. ROHM shall have no responsibility for any damages or losses resulting non-compliance with any applicable laws or regulations.
- 13) When providing our Products and technologies contained in this document to other countries, you must abide by the procedures and provisions stipulated in all applicable export laws and regulations, including without limitation the US Export Administration Regulations and the Foreign Exchange and Foreign Trade Act.
- 14) This document, in part or in whole, may not be reprinted or reproduced without prior consent of ROHM.



Thank you for your accessing to ROHM product informations.
More detail product informations and catalogs are available, please contact us.

ROHM Customer Support System

<http://www.rohm.com/contact/>