



Chipsmall Limited consists of a professional team with an average of over 10 year of expertise in the distribution of electronic components. Based in Hongkong, we have already established firm and mutual-benefit business relationships with customers from,Europe,America and south Asia,supplying obsolete and hard-to-find components to meet their specific needs.

With the principle of “Quality Parts,Customers Priority,Honest Operation,and Considerate Service”,our business mainly focus on the distribution of electronic components. Line cards we deal with include Microchip,ALPS,ROHM,Xilinx,Pulse,ON,Everlight and Freescale. Main products comprise IC,Modules,Potentiometer,IC Socket,Relay,Connector.Our parts cover such applications as commercial,industrial, and automotives areas.

We are looking forward to setting up business relationship with you and hope to provide you with the best service and solution. Let us make a better world for our industry!



Contact us

Tel: +86-755-8981 8866 Fax: +86-755-8427 6832

Email & Skype: info@chipsmall.com Web: www.chipsmall.com

Address: A1208, Overseas Decoration Building, #122 Zhenhua RD., Futian, Shenzhen, China



Features

Switching Regulator

- Boost converter
- Efficiency 93% , >80% with 10% load
- Input range down to 0.65V
- Continuous short circuit protection
- 7µA input current in standby
- -40°C to +100°C operation
- IEC/EN62368-1 certified, CB report

R-78S

0.1 Amp
SIP4
Single Output



IEC/EN62368-1 certified
CB Report
EN55022 Compliant

Description

The R-78S is a DC/DC boost converter designed to run from single cell batteries. The input voltage range of 0.65V-3.3V means that alkaline, NiCd, NiMH, zinc-carbon or lithium chemistry cells can be used to generate a stable 1.8V, 3.3V or 3.6V output to power microprocessors, WLAN/Bluetooth modules and IoT systems. The very high efficiency and low standby consumption can be used to extend battery lifetimes until the „last gasp“ to get the maximum available energy out of the cell. The wide operating temperature of -40°C to +100°C, short circuit protection, OTP, Class A EMC and 3-year warranty round off this high performance converter.

Selection Guide

Part Number	Input Voltage Range ⁽³⁾ [VDC]	Output Voltage [VDC]	Output Current [mA]	Efficiency ⁽¹⁾		Max. Capacitive Load ⁽²⁾ [µF]
				@ min Vin [%]	@ typ. Vin [%]	
R-78S1.8-0.1	0.65-1.3	1.8	100	92	93	470
R-78S3.3-0.1	0.65-3.15	3.3	100	92	93	470
R-78S3.6-0.1	0.65-3.3	3.6	100	92	93	470

Notes:

- Note1: Efficiency is tested at nom. input voltage and full load. (refer to Basic characterisic below)
 Note2: Max. Cap Load is tested by nominal input and full resistive load
 Note3: For more information, please refer to “Output Current vs. Input Voltage Graph” on page I-2

Model Numbering

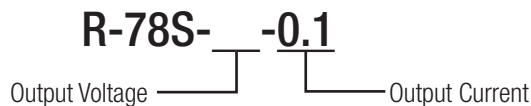

Specifications (measured @ ta= 25°C, 1.5Vin , full load after warm up unless otherwise stated)

BASIC CHARACTERISTICS						
Parameter	Condition			Min.	Typ.	Max.
Input Voltage	R-78S1.8-0.1	nom. Vin=	1.2VDC	0.65VDC	1.2VDC	1.3VDC
	R-78S3.3-0.1		1.5VDC		1.5VDC	3.15VDC
	R-78S3.6-0.1		1.5VDC		1.5VDC	3.3VDC
Under Voltage Lockout	DC-DC OFF				0.4VDC	
Overload Capability ⁽⁴⁾	peak duty cycle 10%					150%, 10s
Quiescent Current	Vout=1.8VDC				100µA	
	Vout=3.3VDC				160µA	
	Vout=3.6VDC				180µA	
Start-up time	Vout=1.8VDC, use E-cap 330µF				4ms	
	Vout=3.3VDC and 3.6VDC				2ms	
Rise time	Vout=1.8VDC, use E-cap 330µF				3.5ms	
	Vout=3.3VDC and 3.6VDC				800µs	
Internal Operating Frequency					1200kHz	
Notes: Note4: For more information, please refer to “Overload Capability Graph” on page I-2 continued on next page						

Specifications (measured @ $t_a = 25^\circ\text{C}$, 1.5Vin, full load after warm up unless otherwise stated)

Parameter	Condition	Min.	Typ.	Max.
Minimum Load			0%	
Dropout Voltage	Vout= 1.8VDC		500mV	
	Vout= 3.3VDC		150mV	
	Vout= 3.6VDC		300mV	
Output Ripple and Noise	20MHz BW, 10%-100% load			100mVp-p
ON/OFF CTRL	DC-DC ON DC-DC OFF		Open or $0.7\text{V} \leq V_{CTRL} < V_{in}$ Short to GND or $V_{CTRL} < 0.1\text{V}$	
Input Current of CTRL pin			5 μA	
Standby Current			7 μA	

Efficiency vs. Load

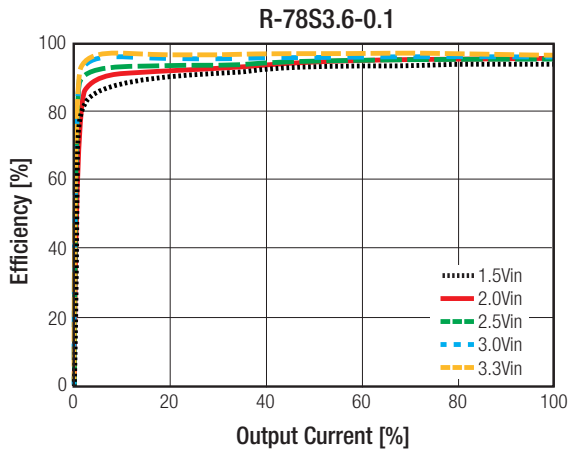
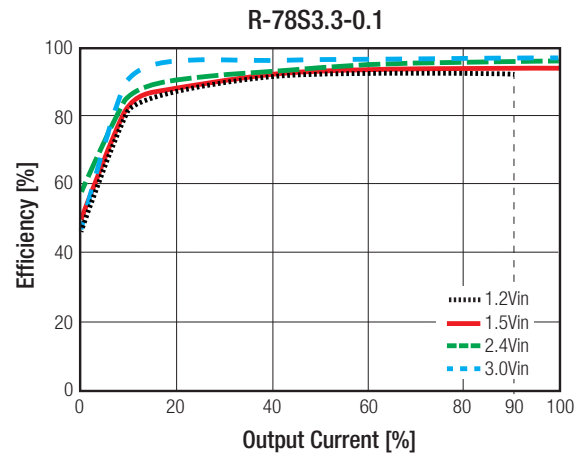
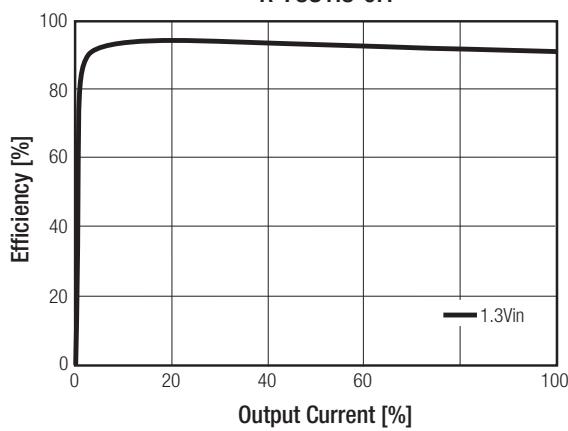

Overload Capability

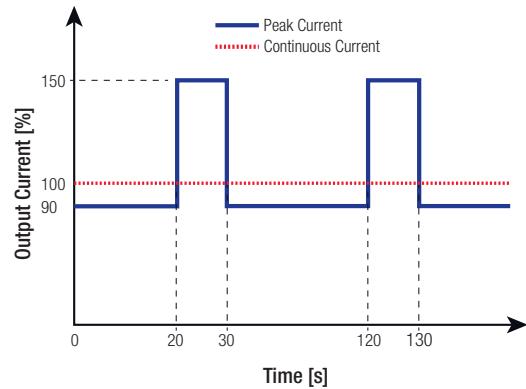

Line Derating

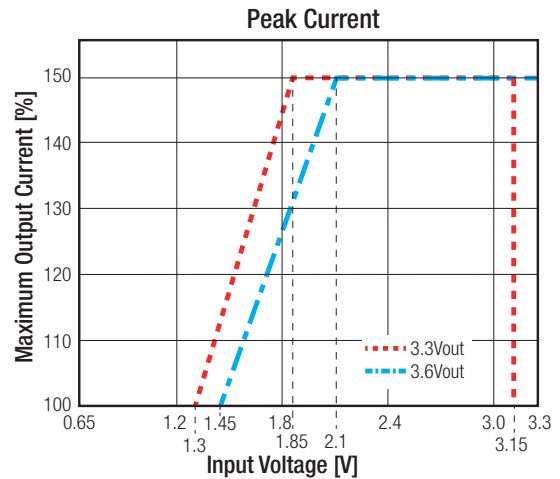
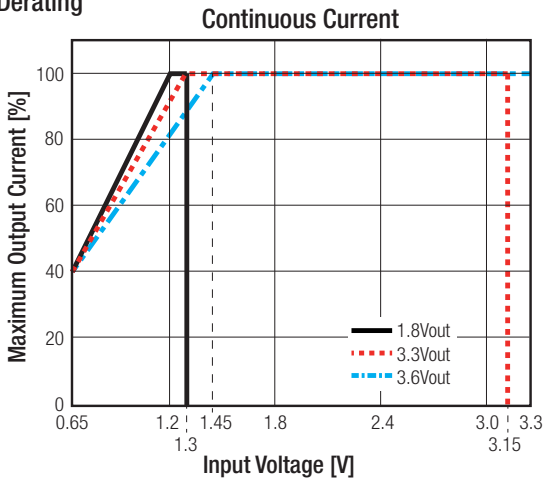

Specifications (measured @ $t_a = 25^\circ\text{C}$, 1.5Vin, full load after warm up unless otherwise stated)

REGULATIONS		
Parameter	Condition	Value
Output Accuracy		$\pm 3.0\%$ typ.
Line Regulation	low line to high line, full load	$\pm 0.3\%$ typ.
Load Regulation	10% to 100% load	$\pm 1.0\%$ typ.

PROTECTIONS		
Parameter	Condition	Value
Short Circuit Protection (SCP)	below 100mΩ	continuous, auto recovery
Over Temperature Protection (OTP)	internal IC	$\geq 150^\circ\text{C}$ shutdown $\leq 130^\circ\text{C}$ restart after cooling down

ENVIRONMENTAL		
Parameter	Condition	Value
Operating Temperature Range	with derating (see graph)	-40°C to $+100^\circ\text{C}$
Maximum Case Temperature		$+105^\circ\text{C}$
Temperature Coefficient		$0.015\%/^\circ\text{C}$
Operating Altitude		5000m
Operating Humidity	non-condensing	5% to 95% RH
Pollution Degree		PD2
MTBF	according to MIL-HDBK-217F, G.B.	$+25^\circ\text{C}$ 89365 x 10^3 hours $+90^\circ\text{C}$ 6963 x 10^3 hours
Vibration		10-55Hz, 2G, 30min along X, Y and Z axis

Derating Graph

(@ Chamber and natural convection 0.1m/s)

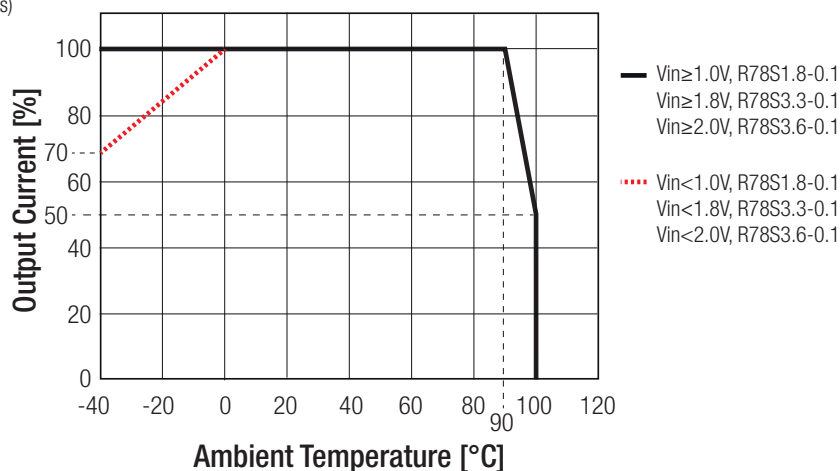

SAFETY AND CERTIFICATIONS		
Certificate Type (Safety)	Report / File Number	Standard
Audio/video, information and communication technology equipment Safety requirements (CB Scheme)	WD-SE-R-170351-00	IEC62368-1, 2nd Edition, 2014 EN62368-1, 2014
RoHs2+		RoHS 2011/65/EU + AM2015/863

continued on next page

Specifications (measured @ $t_a=25^{\circ}\text{C}$, 1.5Vin , full load after warm up unless otherwise stated)

EMC Compliance	Condition	Standard / Criterion
Information technology equipment - Radio disturbance characteristics - Limits and methods of measurement	without external components with external components	EN55022:2010AC:2010, Class A EN55022:2010, Class B
Information technology equipment - Immunity characteristics - Limits and methods of measurement		EN55024, 2010
ESD Electrostatic discharge immunity test	Air $\pm 8\text{kV}$ and Contact $\pm 4\text{kV}$	IEC61000-4-2:2008, Criteria A
Radiated, radio-frequency, electromagnetic field immunity test	3V/m	IEC61000-4-3:2006, Criteria A
Fast Transient and Burst Immunity	$\pm 0.5\text{kV}$	IEC61000-4-4:2012, Criteria A
Surge Immunity	$\pm 0.5\text{kV}$	IEC61000-4-5:2005, Criteria A
Immunity to conducted disturbances, induced by radio-frequency fields	3V	IEC61000-4-6:2013, Criteria A
Power Magnetic Field Immunity	50Hz, 1A/m	IEC61000-4-8:2009, Criteria A

EMC Filtering Suggestions according to EN55022 Class B

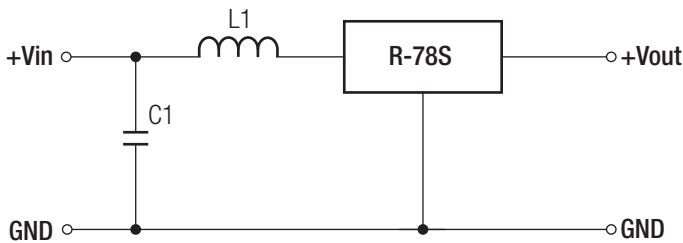

C1	L1
2.2 μF 16V MLCC	1 μH Choke

DIMENSION AND PHYSICAL CHARACTERISTICS

Parameter	Type	Value
Material	Case Potting PCB	non-conductive black plastic, (UL94 V-0) epoxy, (UL94 V-0) FR4, (UL94 V-0)
Package Dimension (LxWxH)		11.6 x 8.5 x 10.4mm
Package Weight		2g typ.

Dimension Drawing (mm)

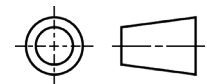
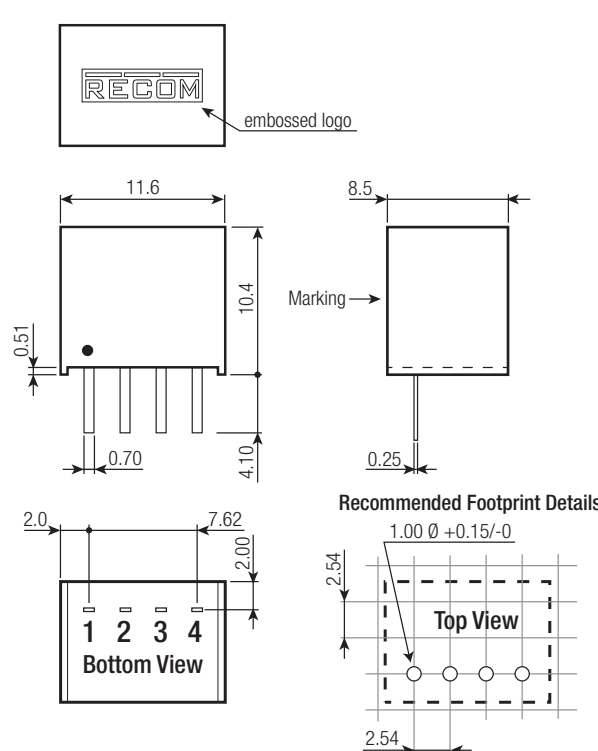

Pin Connections

Pin #	Function
1	+Vin
2	GND
3	+Vout
4	CTRL

Tolerance: xx.x= $\pm 0.5\text{mm}$
 xx.xx= $\pm 0.25\text{mm}$
 Pin width: $\pm 0.1\text{mm}$

Specifications (measured @ $t_a = 25^\circ\text{C}$, 1.5V_{in}, full load after warm up unless otherwise stated)

INSTALLATION AND APPLICATION

Standard Application Circuits

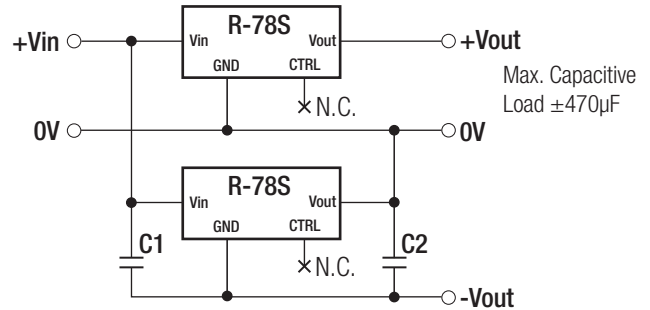
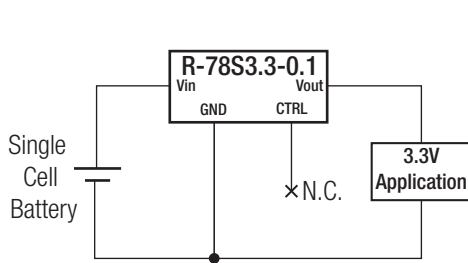

Power-Save Application

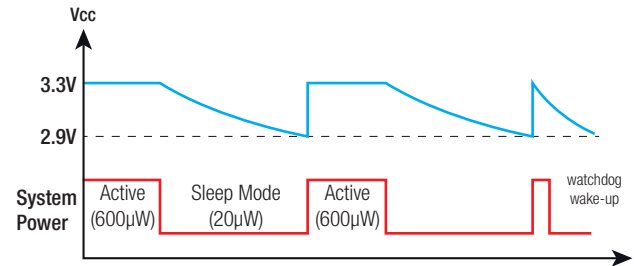
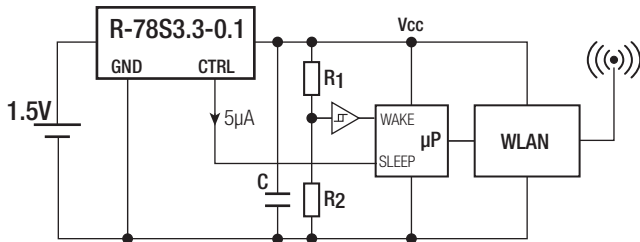

PACKAGING INFORMATION

Parameter	Type	Value
Packaging Dimension (LxWxH)	tube	520.0 x 11.2 x 18.2mm
Packaging Quantity		42pcs
Storage Temperature Range		-55°C to +125°C
Storage Humidity	non-condensing	5% to 95% RH

The product information and specifications may be subject to changes even without prior written notice. The product has been designed for various applications; its suitability lies in the responsibility of each customer. The products are not authorized for use in safety-critical applications without RECOM's explicit written consent. A safety-critical application is an application where a failure may reasonably be expected to endanger or cause loss of life, inflict bodily harm or damage property. The applicant shall indemnify and hold harmless RECOM, its affiliated companies and its representatives against any damage claims in connection with the unauthorized use of RECOM products in such safety-critical applications.