



Chipsmall Limited consists of a professional team with an average of over 10 year of expertise in the distribution of electronic components. Based in Hongkong, we have already established firm and mutual-benefit business relationships with customers from,Europe,America and south Asia,supplying obsolete and hard-to-find components to meet their specific needs.

With the principle of “Quality Parts,Customers Priority,Honest Operation,and Considerate Service”,our business mainly focus on the distribution of electronic components. Line cards we deal with include Microchip,ALPS,ROHM,Xilinx,Pulse,ON,Everlight and Freescale. Main products comprise IC,Modules,Potentiometer,IC Socket,Relay,Connector.Our parts cover such applications as commercial,industrial, and automotives areas.

We are looking forward to setting up business relationship with you and hope to provide you with the best service and solution. Let us make a better world for our industry!



Contact us

Tel: +86-755-8981 8866 Fax: +86-755-8427 6832

Email & Skype: info@chipsmall.com Web: www.chipsmall.com

Address: A1208, Overseas Decoration Building, #122 Zhenhua RD., Futian, Shenzhen, China



SELF-SEALING FASTENERS, NUTS & WASHERS

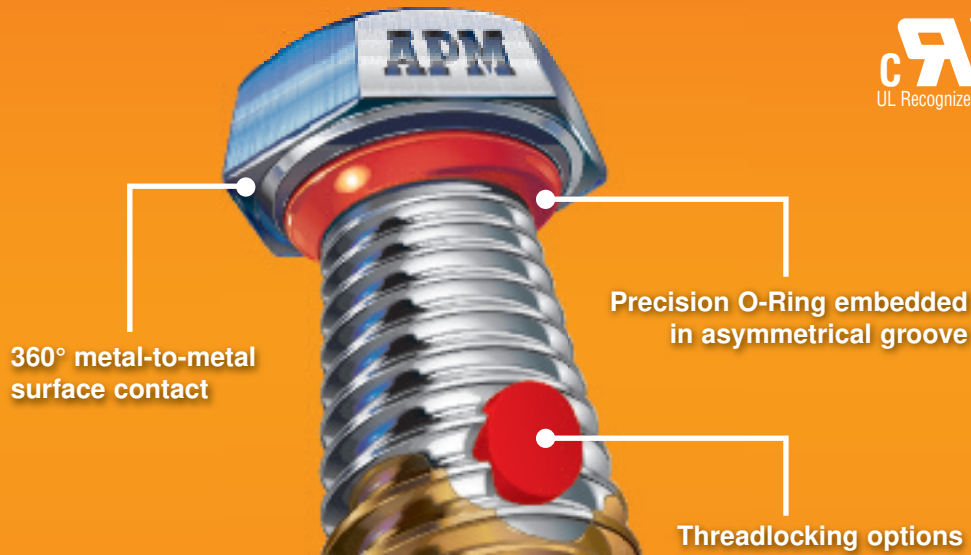

The World's Most Hostile Environments Are Our Proving Grounds®

APM

WHEN JUST FASTENING ISN'T ENOUGH®

Table of Contents

HIGH-PRESSURE REUSABLE SELF-SEALING FASTENERS & WASHERS



Introduction 3

SEELSKREWS® 4

SEELBOLTS® 5

SEELNUTS® 6

SEELRIVETS® 6

SEELOC® Washers 7



THREAD LOCKING ENHANCEMENTS

Pellets 8

Strips (Bars) 9

Patch 10

High-Temperature Patch 11



CUSTOM APPLICATIONS 12

How To Order

SCREW & BOLT CATALOG NUMBERING SYSTEM EXAMPLE

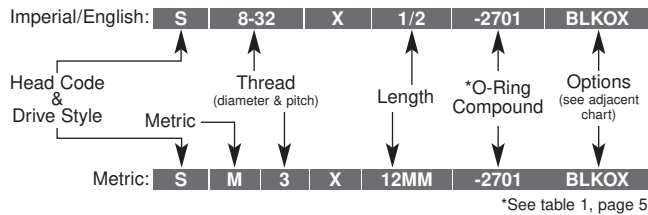

Options

Type	Code
Black Oxide Finish	BLKOX
Self-Locking Add-Ons	See pages 8, 9, 10 & 11 of catalog
Captivating	Per Customer Specifications
Special Cut-Down Lengths	
Painted Heads	

STANDARD BOLT TYPES

Code	Head/Drive	Comments
ST	Hexagonal	Partial/full threaded

STANDARD & TAMPER-RESISTANT SCREW HEAD TYPES

Code	Head	Drive	Comments
S	Pan Head	Slotted	
SL	Oversized Pan Head	Slotted	
R	Pan Head	Recessed Phillips	
SFR	Flat Head (Countersunk)	Recessed Phillips	Phillips bit one size smaller
LB	Pan Head	6-Lobe	"Torx™" compatible
HP	Hex w/Pin (tamper-resistant)		Hex w/Pin
SS	Spanner (tamper-resistant)	Spanner	
OWS	One-Way Slot	Slotted	Tamper-Resistant

TAMPER-RESISTANT DRIVE STYLES (SPECIAL ORDER)

Consult factory for minimum quantity and delivery information.
Diameter Range: #4 thru 1/4" **Length Range:** 1/4 thru 1"
Material: Stainless Steel (18-8)

Drive Style	Type	Head Style Number
	6 Lobe w/Pin	LBP
	Hex w/Pin	HP
	Spanner	SS
	One-Way Slot	OWS

Other drive styles, materials, and sizes available. Please consult factory.

When just fastening isn't enough.[®]

Visit our website
for downloadable
CAD drawings:

www.apmselfsealingfasteners.com

800.498.9034

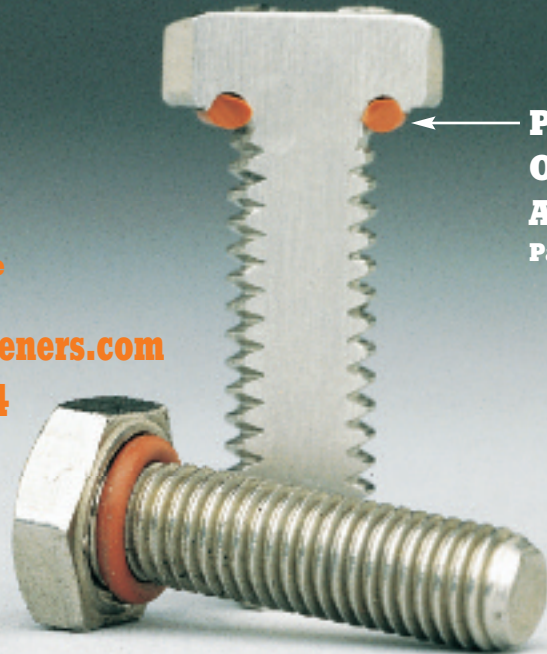

Pre-assembled
O-Ring Seals in
Asymmetrical Groove
Patent No. 3,175,454



Sealing Performance Under High Pressure

APM Hexseal invented and patented pre-assembled self-sealing fasteners designed to provide both fastening and sealing integrity in a single unit. Our design features a resilient O-ring held captive in a precision engineered groove under the fastener head. This combination of precise groove geometry and O-ring characteristics results in an absolute seal regardless of surface finish, while still providing full metal-to-metal contact.

Vibration-resistant and re-usable, SEELSKREWS[®], SEELBOLTS[®], and SEELRIVETS[®] can withstand internal/external pressures up to 20,000 psig/vacuum at temperatures from -160°F to +500°F (-106°C to +260°C).*

Made in the U.S.A., APM self-sealing & self-locking fasteners are available in standard and metric sizes in a wide choice of head and fastening types including self-tapping, and tamper-resistant. Typically, they are furnished in stainless steel/with different finishes or colors as may be required. All have pre mounted silicone rubber O-rings. Other elastomeric materials are also available to match and handle exposure to various chemicals and solvents (see materials table 1 on page 5). Consult factory for further information and pricing.

They represent a superior sealing alternative to sealing compounds, tape, chemical coatings, and deformable washers that attempt to seal the threadform.

Self-Locking Add-Ons

When vibration is also an issue, APM offers a choice of proven resistant and adjustable Nylon threadlocking devices in the form of thread-embedded pellets, strips, and pre-applied thread-patches. Other materials also available. All of our threadlockers contribute and work in concert and add to the basic high-pressure sealing primary function of our fastener line.

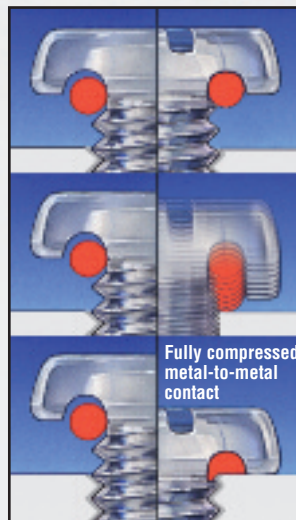

Features and Benefits

- Positive sealing under pressure or vacuum.
- Easy-to-install ... pre-assembled unit installs like a conventional fastener.
- Metal-to-metal contact resists loosening due to vibration, and assures fastening integrity.
- Re-usable ... repeated installation and removal does not affect sealing effectiveness.
- Compatible with all surface finishes.
- UL Recognized Component ... tested and listed to UL Standard 50, Types 1-13.
- Optional O-ring seal materials assure performance with wide variety of gases and liquids.
- Uniformity and high strength assure repeatable performance.
- No adhesives, coatings or tape required.

Typical Applications

- Instrument Housings/Panels
- Pressure Gauges
- Gear Boxes/Transmissions
- Valves
- Motor Housings
- Fuel Tanks
- Cylinders
- Pumps
- Equipment Housings/Cabinets
- Air Conditioning Equipment
- Hydraulic Systems
- Portable Instruments
- Engines
- Medical Equipment
- Military Equipment
- Portable Communications Equipment
- Food Processing Systems
- Or any application where leakage can compromise reliability

SEELSKREW® High-pressure, self-sealing screws



SEELSKREWS® are designed to seal out air, water, lubricants and other liquid or gaseous contaminants. SEELSKREWS® are available in many standard thread sizes and with optional sealing materials. They can also be supplied with either self-locking pellets, strips or patch, anti-seizing coating, a black oxide, painted heads, or in a captivated (KAPTO-SKREW®) configuration. Sheet metal and other type fasteners available on special order.

STANDARD PAN HEAD (available from stock)

TYPE S SLOTTED

THREAD SIZE	LENGTHS*	C MAX.	D MAX.	Recom. Clear. Hole‡	
				MIN.	MAX.
2-56UNC-2A	1/4" to 5/8" incl.	.168"	.055"	.091"	.095"
3-56UNF-2A	1/4" to 5/8" incl.	.194"	.063"	.109"	.113"
3-48UNC-2A	1/4" to 5/8" incl.	.194"	.063"	.109"	.113"
4-40UNC-2A	1/4" to 1" incl.	.220"	.069"	.125"	.129"
5-40UNC-2A	1/4" to 1" incl.	.245"	.075"	.140"	.144"
6-32UNC-2A	1/4" to 1" incl.	.271"	.083"	.147"	.152"
8-32UNC-2A	1/4" to 1" incl.	.323"	.097"	.173"	.179"
10-32UNF-2A	1/4" to 1" incl.	.374"	.113"	.199"	.204"
10-24UNC-2A	1/4" to 1" incl.	.374"	.113"	.199"	.204"
1/4-20UNC-2A	5/16" to 1 1/4" incl.	.493"	.148"	.265"	.269"
1/4-28UNF-2A	5/16" to 1 1/4" incl.	.493"	.148"	.265"	.269"

Consult factory for additional sizes.

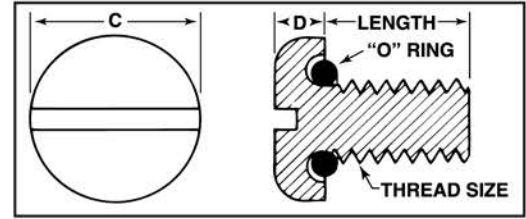

TYPE S SLOTTED

OVERSIZED PAN HEAD (on special order only)

TYPE SL OVERSIZED

THREAD SIZE	LENGTHS in increments of 1/8"	C MAX.	D MAX.	Recom. Clear. Hole‡	
				MIN.	MAX.
4-40UNC-2A	1/4" to 1" incl.	.245"	.075"	.144"	.148"
6-32UNC-2A	1/4" to 1" incl.	.296"	.089"	.171"	.175"
8-32UNC-2A	1/4" to 1" incl.	.373"	.112"	.201"	.205"
10-32UNF-2A	1/4" to 1" incl.	.425"	.125"	.257"	.261"
10-24UNC-2A	1/4" to 1" incl.	.425"	.125"	.257"	.261"

Oversized Head SEELSKREWS® are only for those applications where extra large clearance holes are required. Consult factory for additional sizes.

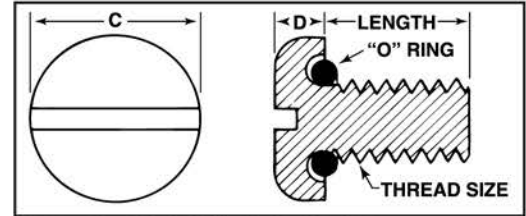

TYPE SL OVERSIZED SLOTTED

METRIC PAN HEAD (available from stock)

TYPE SM SLOTTED

THREAD SIZE	LENGTHS*** (mm)	C MAX. (mm)	D MAX. (mm)	Recom. Clear. Hole‡ (mm)	
				MIN.	MAX.
M2 x 0.4	4 to 12	4.24	1.37	2.31	2.41
M2.5 x 0.45	4 to 12	5.46	2.10	2.67	2.84
M3 x 0.5	4 to 40	6.22	1.90	3.55	3.65
M4 x 0.7	4 to 40	8.17	2.43	4.39	4.54
M5 x 0.8	6 to 40	9.70	3.05	5.56	5.66
M6 x 1	6 to 50	12.49	3.79	6.73	6.83
M8 x 1.25	6 to 50	15.62	4.52	8.45	8.55

Consult factory for additional sizes.

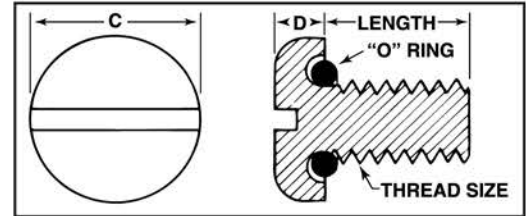

TYPE SM METRIC SLOTTED

STANDARD PAN HEAD (available from stock) TYPE R PHILLIPS RECESSED

THREAD SIZE	HEAD DRIVE SIZE	LENGTHS*	C MAX.	D MAX.	Recom. Clear. Hole‡	
					MIN.	MAX.
2-56UNC-2A	#1	1/4" to 1" incl.	.181"	.062"	.091"	.095"
4-40UNC-2A	#1	1/4" to 1" incl.	.238"	.080"	.125"	.129"
6-32UNC-2A	#2	1/4" to 1" incl.	.294"	.097"	.147"	.152"
8-32UNC-2A	#2	1/4" to 1" incl.	.347"	.115"	.173"	.179"
10-32UNF-2A	#2	3/8" to 1" incl.	.403"	.133"	.199"	.204"
10-24UNC-2A	#2	3/8" to 1" incl.	.403"	.133"	.199"	.204"
1/4-20UNC-2A	#3	3/8" to 1 1/4" incl.	.517"	.175"	.265"	.269"
1/4-28UNF-2A	#3	3/8" to 1 1/4" incl.	.517"	.175"	.265"	.269"

Consult factory for additional sizes.

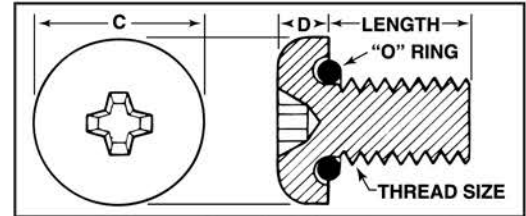

TYPE R PHILLIPS RECESSED (MEETS REQUIREMENTS OF MS 3212 & MS 3213)

METRIC PAN HEAD (available from stock) TYPE RM PHILLIPS RECESSED

THREAD SIZE	HEAD DRIVE SIZE	LENGTHS*** (mm)	C MAX. (mm)	D MAX. (mm)	Recom. Clear. Hole‡ (mm)	
					MIN.	MAX.
M2 x 0.4	#1	4 to 12	4.83	1.60	2.31	2.41
M2.5 x 0.45	#1	4 to 12	5.46	2.10	2.67	2.84
M3 x 0.5	#2	4 to 40	6.70	2.40	3.55	3.65
M4 x 0.7	#2	4 to 40	8.69	3.05	4.39	4.54
M5 x 0.8	#2	6 to 40	9.90	3.70	5.56	5.66
M6 x 1	#3	6 to 50	12.58	4.60	6.73	6.83

Consult factory for additional sizes.

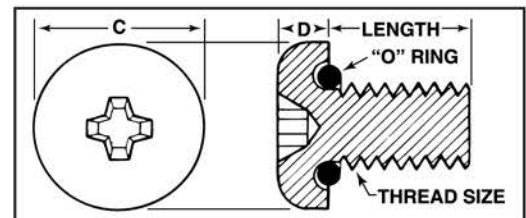

TYPE RM PHILLIPS RECESSED

FLAT HEAD (available from stock) TYPE SFR PHILLIPS RECESSED

THREAD SIZE	HEAD DRIVE SIZE	LENGTHS*	C MAX.	Recom. Clear. Hole‡	
				MIN.	MAX.
2-56UNC-2A**	#1	1/4" to 1" incl.	.172"	.091"	.095"
4-40UNC-2A	#1	1/4" to 1" incl.	.225"	.125"	.129"
6-32UNC-2A	#1	1/4" to 1" incl.	.279"	.147"	.152"
8-32UNC-2A	#2	1/4" to 1" incl.	.332"	.173"	.179"
10-24UNC-2A	#2	5/16" to 1" incl.	.385"	.199"	.204"
10-32UNF-2A	#2	5/16" to 1" incl.	.385"	.199"	.204"
1/4-20UNC-2A	#3	3/8" to 1 1/4" incl.	.507"	.265"	.269"

Metric Flat Head screws also available.

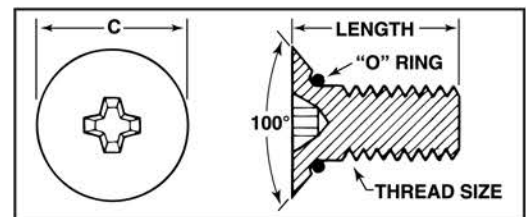

TYPE SFR PHILLIPS RECESSED

*In increments of 1/16" up to 5/8" long; from 5/8" long and up, in increments of 1/8". Tolerance up to 1" (25mm) length: +0 - 1/32" (0.8mm); to 2" (50mm): +0 - 1/16" (1.6mm).

82° countersink. *In one millimeter increments. ‡To assure maximum sealing performance of SEELSKREWS® a clearance hole must be used.

Consult factory for additional sizes.



Visit our website for downloadable PDF drawings:
www.apmselfsealingfasteners.com
 800.498.9034

SEELBOLTS® High-pressure, self-sealing bolts



SEELBOLTS® are designed to seal out air, water, lubricants and other liquids or gaseous contaminants. SEELBOLTS® are available in many standard thread sizes and with optional sealing materials. They can also be supplied with either self-locking pellets, strips or patch, anti-seizing coating, a black oxide, painted heads, or in a captivated (KAPTO-SKREW®) configuration.

TYPE ST HEXAGON HEAD SEELBOLTS

THREAD SIZE	P NOM.	H MAX.	Flats MAX.	Clear. Hole‡		LENGTHS Up to 1" +0 - 1/32 1" to 2" +0 - 1/16
				Min.	Max.	
1/4-28UNF-2A	.510"	.163"	.440"	.265"	.269"	3/8", 1/2", 5/8", 3/4"
1/4-20UNC-2A	.510"	.163"	.440"	.265"	.269"	3/8", 1/2", 5/8", 3/4"
5/16-24UNF-2A	.580"	.211"	.502"	.332"	.336"	1/2", 5/8", 3/4", 7/8"
5/16-18UNC-2A	.580"	.211"	.502"	.332"	.336"	3/8", 1/2", 5/8", 3/4", 7/8"
3/8-24UNF-2A	.650"	.243"	.565"	.395"	.399"	5/8", 3/4", 7/8", 1"
3/8-16UNC-2A	.650"	.243"	.565"	.395"	.399"	1/2", 5/8", 3/4", 7/8", 1"
1/2-20UNF-2A	.870"	.323"	.752"	.530"	.534"	1/2", 5/8", 3/4", 7/8", 1", 1-1/8", 1-1/4"
1/2-13UNC-2A	.870"	.323"	.752"	.530"	.534"	3/4", 7/8", 1", 1-1/8", 1-1/4"

Consult factory for additional sizes.

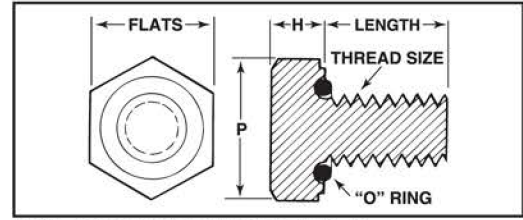

TYPE ST(M) FULLY THREADED

TYPE STM METRIC HEXAGON HEAD SEELBOLTS

THREAD SIZE	LENGTHS* (mm)	P NOM (mm)	H MAX. (mm)	FLATS (mm)	Recom. Clear. Hole	
					MIN. (mm)	MAX. (mm)
M3 x 0.5	6 to 30	6.24	2.13	5.5	3.55	3.65
M4 x 0.7	8 to 30	7.92	2.93	7.0	4.39	4.54
M6 x 1	8 to 50	11.28	4.15	10.0	6.73	6.83
M8 x 1.25	12 to 50	14.69	5.65	13.0	8.45	8.55
M10 x 1.5	12 to 50	19.25	7.18	17.0	10.53	10.64
M12 x 1.75	20 to 50	21.50	8.18	19.0	12.79	12.90
M16 x 2	20 to 50	27.23	10.18	24.0	17.52	17.63

*In two millimeter increments. Consult factory for additional sizes.



SEELSKREW®, SEELBOLT® & SEELNUT® SPECIFICATIONS

Material: SEELSKREWS® and SEELBOLTS® — Stainless steel (passivated). SEELNUTS® — Brass (nickel-plated) or steel (zinc-plated). Other materials available on request. Silicone rubber per A-A-59588 (ZZ-R-765, Class I & II, Grade 70). Other seal materials available.

Threads: Class 2 threads (normal commercial tolerance) are standard on stock SEELSKREWS®, SEELBOLTS® and SEELNUTS®. Class 1 (loose tolerance) and Class 3 (tight tolerance) threads are available on special order.

Temperature Range: -160°F to +500°F (-106°C to +260°C).

Pressure Range: Up to 20,000 psi/vacuum, internal and external, subject to clearance hole dimensions. Check factory for test data.

Shelf Life: Excess of 25 years.

Resistant to: Salt water, weather, dirt, dust, sunlight, ozone and most acids. See Table I.

Agency Evaluations: UL

Installation: Install in same manner as standard fasteners. Standard break-edge practices for deburring (i.e. break-sharp edges of 0.005" maximum) are permissible. Recommended clearance hole depth is 2/3 times thread pitch. See detail below.

Minimum Thread Length: SEELSKREWS®: For machine screws up to 1 1/4" long, the complete thread should extend to within two threads (or closer) of the bearing surface of the head. SEELBOLTS®: For bolts up to 1 1/4" long, the minimum thread length should be twice the diameter plus 1/4" (with a tolerance of plus 2 1/2 threads or 3/16", whichever is greater). For bolts too short for this minimum, the distance from the bearing surface of the head to the first complete thread shall not exceed the length of 2 1/2 threads as measured with a ring thread gauge.

TABLE I: O-RING MATERIAL LIST

Letter Compound	Material	Relevant Specifications	Service Temp °F	RESISTANT TO				TYPICAL PROPERTIES			
				Ozone	Chemicals	Oil	Solvents	Tensile PSI	Elongation %	Abrasion Resistance	Compression Set
S 2701	Silicone Rubber	ZZ-R-765 CLASS I & II	-150° to 500°	Excellent	Good	Good	Fair	500-1800	100-800	Fair	Excellent
L 2615	Fluoro-Silicone Rubber	MIL-R-25988 AMS 3326	-78° TO 450°	Excellent	Good	Excellent	Good	600-1400	100-700	Fair	Excellent
V 5701	Viton® A	MIL-R-83248 CLASS I GR. 75	-20° to 400°	Excellent	Excellent	Excellent	Excellent	2000-2200	300-400	Good	Excellent
N 4601	Buna N (NBR)	ASTM D2000-90 M2BG714	-65° to 250°	Fair	Good	Excellent	Good	1500-3000	400-600	Good	Excellent
E 3601	Neoprene (EPR)	MIL-R-3065 AMS3209	-65° to 300°	Good	Good	Good	Fair	1500-4000	100-700	Excellent	Good
F 7601	Ethylene Propylene (EPDM)	ASTM D2000-90 M3BA708	-65° to 300°	Excellent	Excellent	Poor	Good	1400-1600	500-600	Excellent	Excellent
G —	Hydro-genated Nitrile	ASTM D2000-90 M2BG714 (Green)	-40° to 275°	Excellent	Excellent	Excellent	Good	2000	170	Good	Excellent

Other materials available. Please consult factory. Viton® is a registered trademark of DuPont Performance Elastomers.

INSTALLATION TYPICAL CLEARANCE HOLE DETAIL

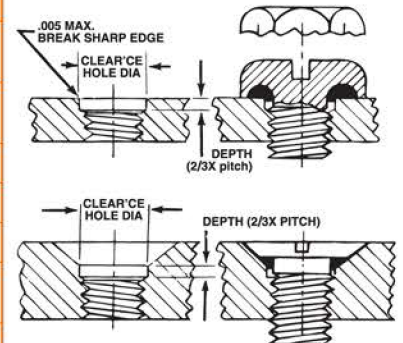

To assure maximum sealing performance of SEELSKREWS® and SEELBOLTS® a clearance hole must be used.

HOW TO ORDER

See inside front cover.



Visit our website for downloadable PDF drawings:
www.apmselfsealingfasteners.com
 800.498.9034

SEELNUTS® High-pressure, self-sealing nuts

SEELNUTS® are designed for use on all types of adjusting screws, threaded studs, and machine bolts in applications where leakage (internal/external) may occur due to extreme pressures. Installed like an ordinary nut, SEELNUTS® form a high-pressure seal along the threaded section and contact surface when torque. Their single-piece design eliminates the need for gaskets, sealing compounds and surface preparations. Fully-adjustable and reusable, they resist vibration and seal under vacuum or high pressure. Available in all standard thread sizes, the integral seal can be formulated for compatibility with most gases or liquids. They can also be supplied with self-locking pellets.

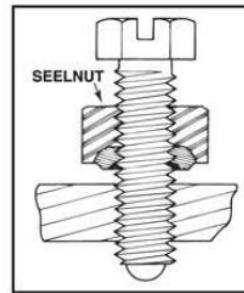
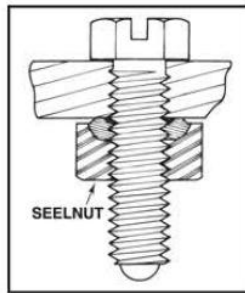
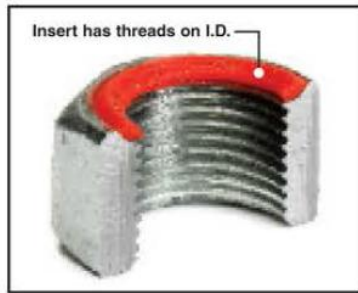

THREAD SIZE	STANDARD SELF-SEALING			JAM NUT	
	F	H	T	F	H
6-32	5/16	9/64	1/64	1/2	7/32
8-32	3/8	5/32	1/64	1/2	7/32
10-32	3/8	5/32	1/64	1/2	7/32
10-24	3/8	5/32	1/64	1/2	7/32
1/4-20	7/16	7/32	1/64	5/8	7/32
1/4-28	7/16	7/32	1/64	5/8	7/32
5/16-18	1/2	17/64	1/64	5/8	7/32
5/16-24	1/2	17/64	1/64	5/8	7/32
3/8-16	9/16	21/64	1/64	5/8	7/32
3/8-24	9/16	21/64	1/64	5/8	7/32
7/16-20	11/16	3/8	1/32	N/A	N/A
1/2-13	3/4	27/64	1/32	3/4	7/32
1/2-20	3/4	27/64	1/32	3/4	7/32
5/8-18	15/16	35/64	1/32	N/A	N/A

Consult factory for additional sizes.

STANDARD SELF-SEALING NUT MATERIAL: Steel Zinc Plated **JAM-NUT MATERIAL:** Nickel-plated brass
Can also be made of carbon steel, stainless- steel, aluminum, etc. Standard rubber is silicone rubber, contact factory for other sealing compounds.

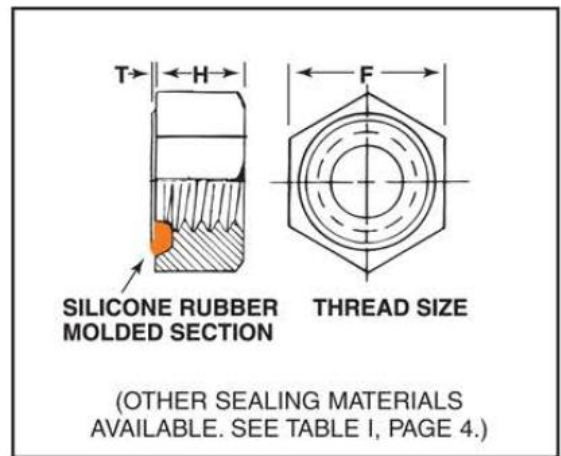

METRIC THREAD SIZE	STANDARD SELF-SEALING		
	F	H	T
M3X0.5	5.5	2.26	0.254
M4X0.7	7	3.02	0.330
M5X0.8	8	3.81	0.406
M6X1	10	4.80	0.508
M8X1.25	13	6.36	0.630
M10X1.5	17	7.86	0.660
M12X1.75	19	9.35	0.860
M14X2	22	10.85	1.010

Consult factory for additional sizes.

METRIC NUT MATERIAL: Stainless-Steel

Can also be made of carbon steel, nickel-plated brass, aluminum, etc. Standard rubber is silicone rubber, contact factory for other sealing compounds.

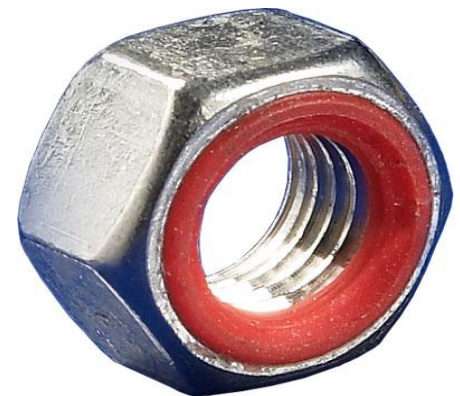

SEELRIVETS® High-pressure, self-sealing rivets

SEELRIVETS® are designed to seal out air, water, lubrications and other liquid or gaseous contaminations. Installed like an ordinary rivet, SEELRIVETS® form a high-pressure seal while permitting metal-to-metal contact. SEELRIVETS® are universal head furnished in aluminum alloy for industrial applications. See below for SEELRIVETS® types. CONTACT FACORTY FOR AVAILABLE SIZES, TYPES, MATERIALS AND O-RING MATERIALS.

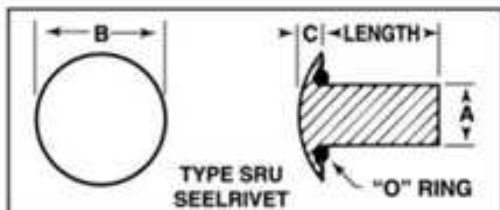

TYPE SRU (Universal Head)

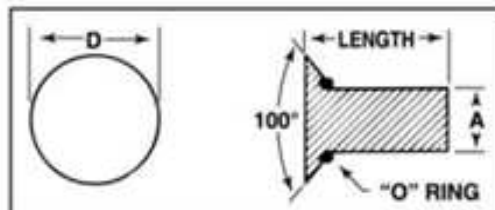

TYPE SRC (Flat Head)

AIR & LIQUID-TIGHT BONDED SELF-SEALING WASHERS

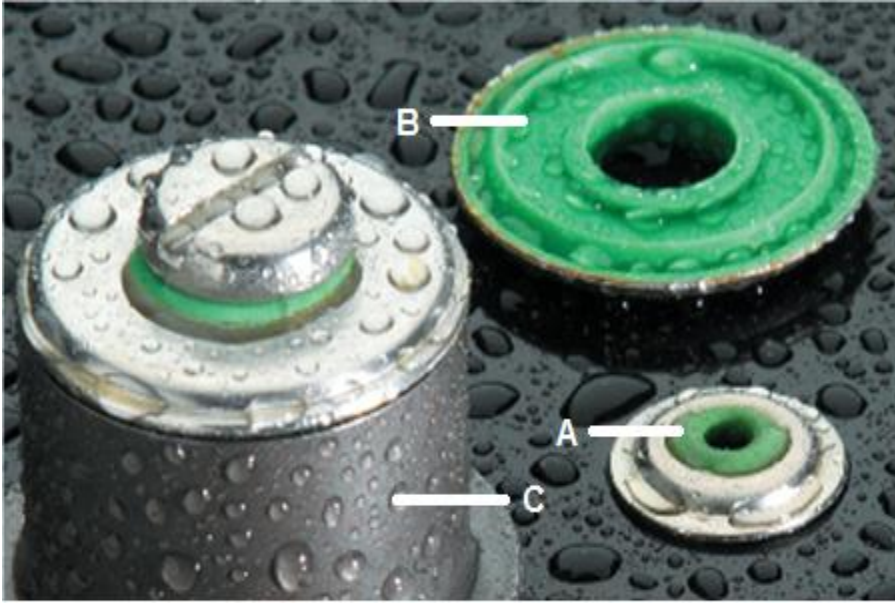

TYPICAL APPLICATIONS

- Electrical Enclosures meeting NEMA Standards
- Laboratory Equipment & Scientific Instruments
- Manufacturing & Process Equipment i.e., Food, Chemical, Pharmaceuticals, etc.
- Material Handling & Packaging Equipment
- Motion & Control Equipment
- Networking & Communications Equipment
- Test & Measurement Equipment
- Contract Manufacturing & Fabrication
- Boat & any Marine-related Equipment
- Construction & Off-Road Equipment
- Industrial & any Specialized Application Equipment
- Powder & Liquid Handling Equipment
- Filtration & Separation Equipment
- Monitoring & Control Equipment
- Military & Security Equipment
- Custom & Metal Fabricators



Plus anything that is exposed
to a spray or wash downs



SEELOC® High-Pressure Washers—Reusable & Vibration-Resistant

SEELOC® washers consist of silicone rubber bonded to formed stainless steel washers, and are designed for a variety of electrical and mechanical applications. SEELOC® washers are used with conventional screws, bolts or studs to complete the sealing and locking action. *UL

Recognized (UL Type 4X/6 enclosures) and IP66/68 water ingress rated, SEELOC® is an ideal sealing solution in a wide variety of mechanical, electrical and electronics applications that require high-performance, air/liquid-tight sealing. Upon compression, the bonded, dish shaped silicone rubber sealing disc makes full 360° horizontal surface contact from the hub to the mounting hole (see A). The silicone rubber also makes full vertical contact with the screw/bolt shank/threads – thus completing the high-pressure seal. This would be a difficult feat for an ordinary O-Ring, or any sealing washer that does not fully make fastener contact. The SEELOC® silicone contact surface landscape features a continuous ridge (see B), creating a contoured sealing barrier, as well as a periphery locking joint, when used for mounting on a protruding round extended surface (see C). Extra large size holes or odd shaped adjustment-slots, in addition to conventional mounting holes, also benefit from these precision, reusable sealing washers. SEELOC® washer technology is perfect for any securing application where spray, vapors or wash-down is present, and where future maintenance may be of concern due to contaminant exposure from salt spray, ozone, UV, lubricants, cleaning solvents, etc.

*Inch Seeloc® Washer Range

APM Part No.	For Thread Size	Washer O.D.	Max. Thru-Hole Size (inch/mm)
75601	#6	1/2"	1/4 / 6.35
75801	#8	1/2"	1/4 / 6.35
75101	#10	1/2"	1/4 / 6.35
75602	#6	1"	3/8 / 9.53
75802	#8	1"	5/8 / 15.87
75102	#10	1"	5/8 / 15.87
75082	1/4	1"	5/8 / 15.87
75107	5/16	1"	5/8 / 15.87
75122	3/8	1"	5/8 / 15.87
75142	7/16	1"	5/8 / 15.87
75162	1/2	1"	5/8 / 15.87
75603	#6	1 1/2"	1 / 25.4
75803	#8	1 1/2"	1 / 25.4
75103	#10	1 1/2"	1 / 25.4
75083	1/4	1 1/2"	1 / 25.4
75108	5/16	1 1/2"	1 / 25.4
75123	3/8	1 1/2"	1 / 25.4
75143	7/16	1 1/2"	1 / 25.4
75163	1/2	1 1/2"	1 / 25.4

Consult factory for additional sizes.
Optional black oxide finish available.

Metric Seeloc® Washer Range

APM Part No.	For Thread Size	Washer O.D.	Max. Thru-Hole Size (mm)
75031	M3	12.7 mm	6.35
75041	M4	12.7 mm	6.35
75051	M5	12.7 mm	6.35
75032	M3	25.4 mm	9.53
75042	M4	25.4 mm	15.87
75052	M5	25.4 mm	15.87
75062	M6	25.4 mm	15.87
75312	M8	25.4 mm	15.87
75392	M10	25.4 mm	15.87
75472	M12	25.4 mm	15.87

Consult factory for additional sizes.
Optional black oxide finish available.

SEELOC® SPECIFICATIONS

Material: Standard Seeloc® washer 300 Series is stainless steel, but can be made in carbon steel, nickel-plated brass, aluminum, etc. Silicone rubber is standard.*

Temp. Range: -160°F to +500°F (-106°C to +260°C)

Pressure Range: 0 to 100 psig internal and external.

Shelf Life: in excess of 25 years.

Resistant to: salt water, acids, weather, sunlight, ozone, etc.

Installation: Seeloc® washers are installed on bolts, screws or studs in the same manner as regular washers. The rubber section should always face the panel.

Rating: *IP66/68. UL Recognized for Type 4X & Type 6 enclosure protection.

*Consult materials chart for alternatives.

Bottom View-Facing Contact Surface

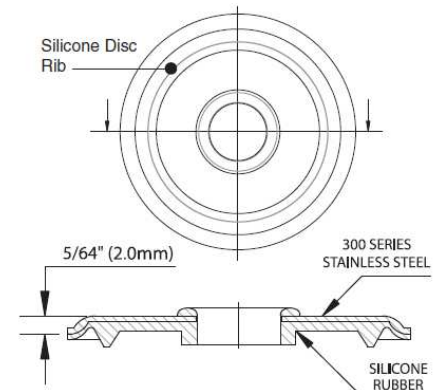

44 Honeck Street
Englewood, NJ 07631
Tel: 201-569-5700 Fax: 201-569-4106
www.apmhexseal.com

ADJUSTABLE LOCKING PELLETS FOR SEELSKREW®, SEELBOLT® & SEELNUT® SELF-SEALING FASTENERS

FULLY ADJUSTABLE & REUSABLE PER IFI 124, IFI 524 & MIL-DTL-18240F, NASM25027

When assembled with a mating part the resilient engineered polymer pellet (normally Nylon) is compressed, and a locking action is established. APM Pellet Locking action takes place inside the threads due to its vibration dampening characteristics, as opposed to at the bearing surface. The resilience of the pellet holds the fastener in place without adhesives or thread distortion. The pellet's resiliency also contributes to its superior degree of adjustability and repeated reusability. See pages 4, 5 & 6 of this catalog for complete list of fastener sizes to apply.

Self-Sealing screws, bolts and nuts that have pellets installed can operate and deliver outstanding performance in both high and low temperature extremes without degradation. Under most operating conditions, these pellets are unaffected by vibration or reversal of stress. Installed in a drilled hole (just below the depth of the thread), APM pellets are typically positioned one to three threads back from the end of the fastener to assure ease of starting. Hole positioning can be modified to meet specific applications – contact Technical Sales for assistance.



FEATURES

- Resistant to vibration and reversal of stress, APM pellets lock whether fasteners are seated or unseated.
- Saves money by eliminating the need for costly lock washers, cotter pins or castellated nuts. You get a close fit without expensive close tolerances. APM pellets are less expensive than applying bottled thread locking compounds at the point of assembly.
- APM pellets are virtually impervious to a wide range of chemicals, water and motor fluids. They won't dry, shrink or lose resiliency when exposed to commercial solvents, alcohol, gasoline, oil, caustic soda, and many other chemicals.

HOW TO ORDER

Specify the head type, thread size, length, followed by the Ordering Code.

Example: To order a slotted pan head SEELSKREW, with a 8-32 thread, 1 inch long, with standard silicone o-ring, black oxide finish and Nylon pellet order...
S8-32X1-2701-BLKOX-NY

See inside front cover How To Order information for additional assistance.

SPECIFICATIONS

Material	Reusability	Effective Temperature Range	Ordering Code
Nylon	Up to 15 on/off cycles	-65°F to +250°F (-54°C to +121°C)	NY
KEL-F*	0 (one installation and one removal)	-320°F to +390°F (-196°C to +198°C)	NB
VespeL**	Up to 5 on/off cycles	-450°F to +500°F (-268°C to +260°C)	NBR

* KEL-F is a registered trademark of Minnesota Mining and Manufacturing Co.

** VespeL and Teflon are registered trademarks of E.I. DuPont De Nemours & Co.



800.498.9034

LOCKING STRIP (BAR) FOR SEELSKREW® & SEELBOLT® SELF-SEALING FASTENERS

REUSABLE TO +550°F (288°C) PER IFI 124, IFI 524 & MIL-DTL-18240, VARIOUS NAS, AN, & MS CALLOUTS

A resilient engineered polymer bar (strip) is inserted into a precise slot that has been milled into the threads making the fastener self-locking as well as self-sealing, while remaining fully adjustable. The APM Strip delivers outstanding performance in both high and low temperature extremes.

When assembled with a mating part the resilient APM Strip (usually Nylon) is compressed which provides a locking action in the thread instead of at the bearing surface due to vibration dampening characteristics. The fastener is held in place without the use of adhesives or thread distortion. The result is a self-sealing reusable fastener that is both locking and repeatedly adjustable. APM Strips are typically positioned one to three threads back from the end of the fastener to assure ease of starting. Special strip positioning can be tailored to fit your needs – contact Technical Sales for assistance.



FEATURES

- Under most conditions, our self-sealing fasteners with Strips are unaffected by vibration or reversal of stress. APM Strips lock whether the fastener is seated or unseated.
- APM Strip fasteners require no costly lock-washers, cotter pins, or castellated nuts. APM Strips provide close fits without the expense involved in attaining close tolerances, and are less expensive than applying bottled thread locking compounds at the point of assembly.
- APM Strips will not dry, shrink, or lose resiliency when exposed to commercial solvents, alcohol, gasoline, oil, caustic soda, etc.

HOW TO ORDER

Specify the head type, thread size, length, followed by the Ordering Code.

Example: To order a slotted pan head SEELSKREW, with a 8-32 thread, 1 inch long, with a standard silicone o-ring, black oxide finish and a KEL-F strip order...
S8-32X1-2701-BLKOX-LB

See inside front cover How To Order information for additional assistance.

SPECIFICATIONS

Material	Reusability	Effective Temperature Range	Ordering Code
Nylon 6/6	Up to 15 on/off cycles	-65°F to +250°F (-54°C to +121°C)	LY
KEL-F*	0 (one installation and one removal)	-320°F to +390°F (-196°C to +198°C)	LB
Vespel**	Up to 5 on/off cycles	-450°F to +500°F (-268°C to +260°C)	LBR
Teflon**	Up to 5 on/off cycles	-450°F to +550°F (-268°C to +288°C)	LW
Copper	Up to 5 on/off cycles	-400°F to +400°F (-240°C to +204°C)	LC
Stainless Steel	0 (one installation and one removal)	-400°F to +1200°F (-240°C to +649°C)	LS

* KEL-F is a registered trademark of Minnesota Mining and Manufacturing Co.
** Vespel and Teflon are registered trademarks of E.I. DuPont De Nemours & Co.



800.498.9034

PATCH FOR LOCKING & SEALING – PRE-APPLIED TO SEELSKREW® & SEELBOLT® SELF-SEALING FASTENERS

VIBRATION-DAMPENING ACTION ON THE THREAD SURFACE is achieved while still allowing repeated adjustment & reuse.

The APM Patch dry coating process is fused to the thread surface and delivered ready to be installed without the need for curing or any other special preparation. When assembled with a mating part the resilient engineered polymer (normally Nylon) Patch is compressed providing a locking action in the thread instead of at the bearing surface due to its vibration dampening characteristics. The resilience of the APM Patch holds the fastener in place without adhesives or thread distortion. Generally the Patch coating is applied 120° to 4-6 threads, starting 1-3 threads back from the end. Modified Patch location and coating length can be specified for specific applications.



FEATURES

- Patch provides excellent locking performance as well as increased sealing ability by completely filling the thread root with an elastic nylon dam.
- APM Patch process involves no drilling or milling, so there is no loss of the fastener's strength or hardness and no troublesome burrs or chips.
- Saves money by eliminating the need for costly lock washers, cotter pins, or castellated nuts. You get a close fit without the costs involved in obtaining close tolerances. And, applying the Patch is less expensive than applying bottled threadlocking compounds at the point of assembly.
- Resists heat and cold, and meets or exceeds IFI Specifications 124 & 524, as well as Military Specification MIL-DTL-18240F, Type P, for temperatures up to +250°F (up to +121°C).
- APM Patch will not dry, shrink, or lose resiliency when exposed to commercial solvents, alcohol, gasoline, oil, caustic soda, jet fuel, etc.
- The addition of the Patch greatly reduces the need for retightening. It can be reused repeatedly without damage to threads, and is particularly resistant to deformation.

SPECIFICATIONS

Primary Usage: Lock and Seal

Reusability: Up to 15 on-off cycles

Material: Nylon 11

Color: Yellow (other colors available upon request*)

Hardness: Shore D (ASTM D2240) 70-80 Durometer

Salt Spray Resistance: (ASTM B117) 1000+ hours (X scribe)

Taber Abrasion: (ASTM D4060) 10-18 mg loss CS-10 wheel, 1000 g load, 1000 cycles (varies with color)

Dielectric Strength: (ASTM D149) 800-1200 volts/mil @10.0 mils (varies with color)

Direct Impact resistance: (MPTM 0002) 160 in. lbs. (@10.0 mils)

Shelf Life: The on part shelf life is at least one year under ideal storage conditions (+4°C to +32°C, or +40°F to +90°F).

*QPL-18240 & MIL-DTL-18240F require yellow Nylon

HOW TO ORDER

Ordering Code: TP

Example: To order a slotted pan head SEELCKREW, with a 8-32 thread, 1 inch long, with a silicone o-ring, black oxide finish, and with a Nylon patch order...
S8-32X1-2701-BLKOX-TP

APM

800.498.9034

HIGH-TEMPERATURE PATCH FOR LOCKING & SEALING – PRE-APPLIED TO SEELSKREW®, SEELBOLT® & SEALNUT® SELF-SEALING FASTENERS

HIGH-TEMPERATURE PERFORMANCE – Maintains torque values through temperatures from -70°F (-57°C) to +500°F (+260°C)

A specially formulated Nylon high-temperature Patch is generally applied to a minimum of 2-3 threads from the fastener end with 4-6 threads of coverage to assure ease of starting the nut/bolt assembly. When the mating threads are engaged, the patch is compressed creating a dam-like action on the opposite side of the coating resulting in very strong metal-to-metal contact. When the high-temperature patch is fully seated, it forms a positive lock that will not loosen, *even under extreme vibration*. This dam-like action adds to the high-pressure sealing characteristics of the O-ring & groove sealing design of our self-sealing fasteners.



FEATURES

- **Retains Full Strength:** APM Hi-Temperature Patch process involves no drilling or milling, so there is no loss of the fastener's strength or hardness and no troublesome burrs or chips.
- **Saves Money & Time:** APM Hi-Temperature Patch eliminates the need for expensive lock washers, cotter pins, or castellated nuts, and bottled thread locking compounds at the point of assembly. The Patch remains secure; fasteners coated with APM patch can be automatically fed through standard bowl feeders without fear of material falling off.
- **Chemical resistance:** APM HI-Temperature Patch will not dry, shrink or otherwise be affected when exposed to commercial solvents, alcohol, gasoline, oil, caustic soda, jet fuel, etc.
- **Reusable:** APM fasteners coated with the Hi-Temperature Patch can be reused repeatedly with out damage to the threads. The patch is particularly resistant to deformation which makes it ideal for repeated use.
- **Eliminates Secondary Sorting:** During the patch application process, camera systems are used to verify the parts are precisely coated – thus eliminating the need for customer secondary sorting.

SPECIFICATIONS

- Primary Usage:** Lock and Seal
- Reusability:** Up to 5 on-off cycles
- Material:** Reinforced Nylon
- Color:** Orange and Gray*
- Hardness:** Shore D (ASTM D2240) 70-80 Durometer
- Salt Spray resistance:** (ASTM B117) 1000+ hours (X scribe)
- Taber Abrasion:** (ASTM D4060) 10-18 mg loss CS-10 wheel, 1000 g load, 1000 cycles
- Dielectric Strength:** (ASTM D149) 800-1200 volts/mil @10.0 mils
- Direct Impact resistance:** (MPTM 0002) 160 in. lbs. (@10.0 mils)

*QPL-18240 & MIL-DTL-18240F requires gray nylon.

HOW TO ORDER

- Ordering Code:** HTP
- Example:** To order a slotted pan head SEELCKREW, with a 8-32 thread, 1 inch long, with a silicone o-ring, black oxide finish, and with a high temperature Nylon patch order... S8-32X1-2701-BLKOX-HTP

See inside front cover How To Order information for additional assistance.

APM

800.498.9034

CUSTOM & NOT-SO-CUSTOM

This catalog lists our standard types and sizes most frequently requested which are stocked for prompt delivery by us and our network of authorized distributors. We are pleased to honor any requests for other fastener types and heads (including venting), not shown in this catalog, or special machining, drilling, or finishes. We also welcome requests for assemblies that go beyond the basic fastening challenge. APM also offers complete elastomeric custom molding and bonding capabilities. For

example, incorporating our SEELSKREW®s, APM provides integrated elastomeric-silicone molded seals with/without metal flanges (see photo below). We can custom design or

manufacture to your prints or supplied samples. That's because APM is a fully integrated manufacturer with a world-wide reputation as a developer and manufacturer of complete custom static and dynamic sealing solutions. We're a lot more than just fasteners. *Please visit our other web site for more capability detail: www.apmhexseal.com*

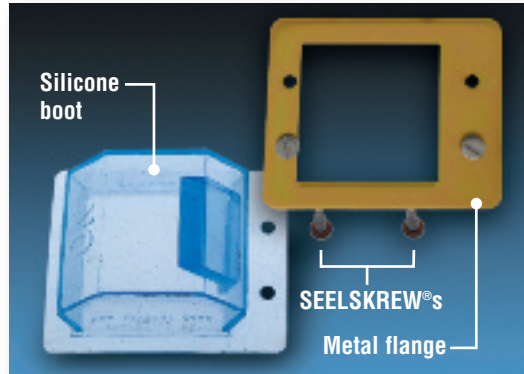

Example: Panel mounted circuit breaker environmental sealing housing

SELF-SEALING FASTENERS – ONE OF THE MANY SEALING SOLUTIONS OFFERED BY APM, FROM HEAVY-DUTY INDUSTRIAL TO ELECTRONICS

Beyond offering industry the broadest line of self-sealing fastening hardware, APM, for more than half a century, has been the prime developer of elastomeric sealing boot enclosures. They are designed to increase reliability and prolong the life of switches, circuit breakers, potentiometers

and encoders in hostile environments. Rated to IP68, the UL Recognized Component boots are used extensively by the U.S. military, medical, marine, electrical-electronics & communications, plant-process, construction, outdoor recreation in a wide variety of industries worldwide.



HEXSEAL® Switch, Potentiometer, Encoder Sealing Boots



HEXSEAL® Circuit Breaker Sealing Boots

www.apmhexseal.com

FREE SAMPLES & SUPPORT

APM is always pleased to provide free samples*, quotations and engineering assistance. Because of our vast experience in self-sealing and self-locking fastener technology, there's a good chance we have dealt with a same or similar application and would be pleased to share our knowledge. For local service, please visit our web site for names of local APM HEXSEAL Manufacturers' Representatives and local and national Authorized Distributors.

*Visit our website and print out our Request For Samples form.



For more than half a century, APM has been the single source for more than just basic fastening.

APM HEXSEAL®

WHEN JUST FASTENING ISN'T ENOUGH®

44 Honeck Street • Englewood NJ 07631 • Toll Free: (800) 498-9034 • Fax: (201) 569-4106 • www.apmselfsealingfasteners.com

HEXSEAL®, SEELSKREWS®, SEELBOLTS®, SEELRIVETS®, SEELLOC® & KAPTO-SKREWS® are U.S. Registered Trademarks of APM HEXSEAL CORPORATION.

Printed in USA
APM 2010-7.5