



Chipsmall Limited consists of a professional team with an average of over 10 year of expertise in the distribution of electronic components. Based in Hongkong, we have already established firm and mutual-benefit business relationships with customers from,Europe,America and south Asia,supplying obsolete and hard-to-find components to meet their specific needs.

With the principle of "Quality Parts,Customers Priority,Honest Operation,and Considerate Service",our business mainly focus on the distribution of electronic components. Line cards we deal with include Microchip,ALPS,ROHM,Xilinx,Pulse,ON,Everlight and Freescale. Main products comprise IC,Modules,Potentiometer,IC Socket,Relay,Connector.Our parts cover such applications as commercial,industrial, and automotives areas.

We are looking forward to setting up business relationship with you and hope to provide you with the best service and solution. Let us make a better world for our industry!



## Contact us

Tel: +86-755-8981 8866 Fax: +86-755-8427 6832

Email & Skype: info@chipsmall.com Web: www.chipsmall.com

Address: A1208, Overseas Decoration Building, #122 Zhenhua RD., Futian, Shenzhen, China



# R2A20133DSP

R03DS0052EJ0401

Rev.4.01

Jan 08, 2016

## Critical Conduction Mode PFC Control IC

### Description

The R2A20133D controls a boost converter to provide an active power factor correction.

The R2A20133D adopts critical conduction mode for power factor correction and realizes high efficiency and a low switching noise by zero current switching.

Because the zero current is detected by using the GND current, the ZCD Auxiliary winding is unnecessary.

The feedback loop open detection, two mode overvoltage protection, overcurrent protection are built in the R2A20133D, and can constitute a power supply system of high reliability with few external parts.

### Features

- Absolute Maximum Ratings
  - Supply voltage  $V_{cc}$ : 24 V
  - Junction temperature  $T_j$ :  $-40$  to  $+150^{\circ}\text{C}$
- Electrical characteristics
  - UVLO operation start voltage  $V_H$ :  $9.5\text{ V} \pm 0.7\text{ V}$
  - UVLO operation shutdown voltage  $V_L$ :  $8.5\text{ V} \pm 0.4\text{ V}$
  - UVLO hysteresis voltage  $H_{ysuvl}$ :  $1.0\text{ V} \pm 0.4\text{ V}$
- Functions
  - Boost converter control with critical conduction mode
  - Two mode overvoltage protection and OVP2
    - Mode 1: Dynamic OVP corresponding to a voltage rise by load change
    - Mode 2: Static OVP corresponding to overvoltage in stable.
    - OVP2: OVP2 senses the PFC output voltage by independence pin.
  - Feedback loop, open detection
  - Overcurrent protection
  - Dynamic UVP corresponding to a voltage fall by load change
  - Frequency limiter, adjustable
  - Zero Current Detect (ZCD) delay time, adjustable
  - CS pin's open detection
  - Package lineup: Pb-free SOP-8 (JEDEC)

### Ordering Information

Part No.	Package Name	Package Code	Package Abbreviation	Taping Abbreviation (Quantity)
R2A20133DSP#W5	—	PRSP0008DJ-A	SP	W (2,500 pcs/reel)

## Pin Arrangement

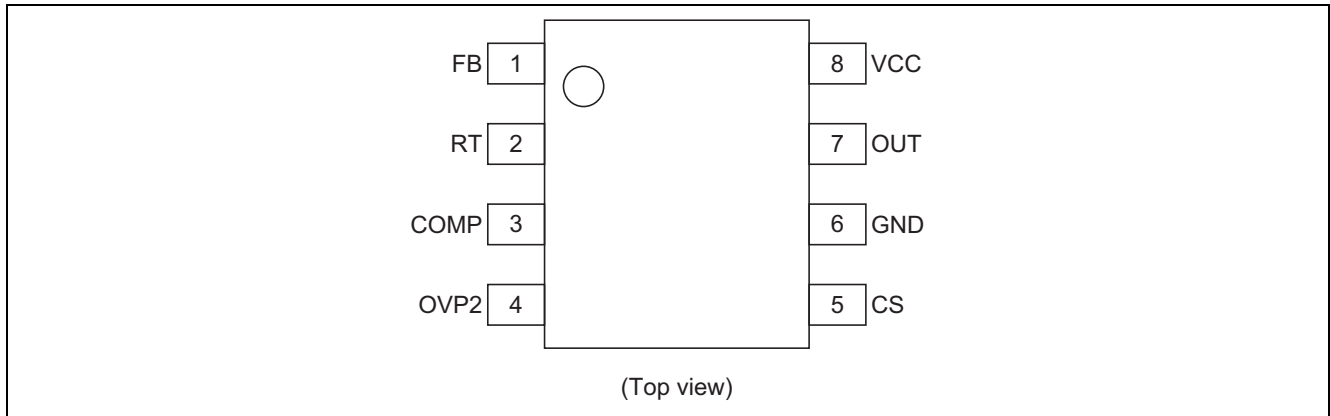

## Pin Functions

Pin No.	Pin Name	Function
1	FB	Error amplifier input terminal
2	RT	Max-ON time, ZCD-delay and Frequency limiter adjustment terminal
3	COMP	Error amplifier output terminal
4	OVP2	Over voltage detection terminal
5	CS	Zero current detection and overcurrent detection input terminal
6	GND	Ground
7	OUT	Power MOSFET drive terminal
8	VCC	Supply voltage terminal

### Block Diagram

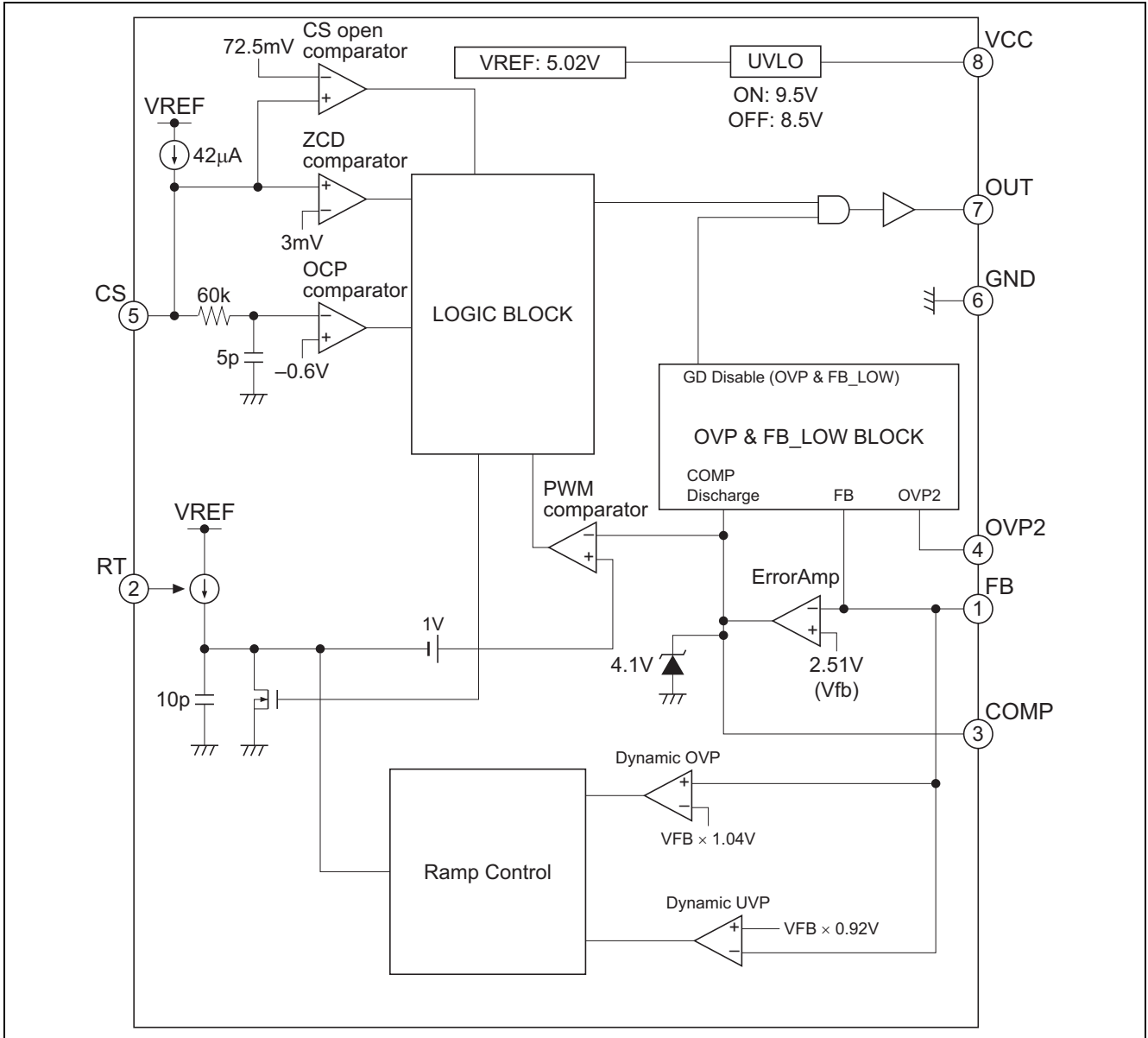

## Absolute Maximum Ratings

(Ta = 25°C)

Item	Symbol	Ratings	Unit	Note
Supply Voltage	VCC	-0.3 to +24	V	
OUT terminal peak current	l <sub>pk</sub> -snk-out l <sub>pk</sub> -src-out	+0.9 -0.5	A	3
OUT terminal DC current	l <sub>dc</sub> -snk-out l <sub>dc</sub> -src-out	+100 -50	mA	
COMP terminal current	l <sub>comp</sub>	+1 -1	mA	
RT terminal current	l <sub>rt</sub>	-50 to -2	μA	
Terminal voltage	V <sub>t</sub> -group1	-0.3 to VCC	V	4
	V <sub>t</sub> -group2	-0.3 to 5.3		5
CS terminal voltage	V <sub>cs</sub>	-5 to +0.3	V	
Power dissipation	P <sub>t</sub>	0.68	W	6
Operating ambient temperature	T <sub>a</sub> -opr	-40 to +125	°C	
Junction temperature	T <sub>j</sub>	-40 to +150	°C	7
Storage temperature	T <sub>stg</sub>	-55 to +150	°C	

Notes: 1. Rated voltages are with reference to the GND terminal.

2. For rated currents, inflow to the IC is indicated by (+), and outflow by (-).

3. Shows the transient current when driving a capacitive load.

4. This is the rated voltage for the following pins:  
OUT

5. This is the rated voltage for the following pins:  
FB, COMP, OVP2, RT

6.  $\theta_{ja} = 120^{\circ}\text{C/W}$

This value is a thing mounting on  $40 \times 40 \times 1.6$  [mm], a glass epoxy board of wiring density 10%.

7. Stresses exceeding the absolute maximum ratings may damage the device.

These are stress ratings only. Functional operation above the recommended operating ambient temperature range is not implied.

Extended exposure to stresses above the absolute maximum ratings may affect device reliability.

## Electrical Characteristics

(Ta = 25°C, VCC = 12 V, CS = 0.04 V, FB = 2 V, COMP: Open, OVP2 = 1 V, RRT = 200 kΩ)

Item	Symbol	Min	Typ	Max	Unit	Test Conditions	
Supply	UVLO turn-on threshold	Vuvlh	8.8	9.5	10.2	V	
	UVLO turn-off threshold	Vuvll	8.1	8.5	8.9	V	
	UVLO hysteresis	Hysuvl	0.6	1.0	1.4	V	
	Standby current	Istby	—	100	200	μA	VCC = Vuvlh – 0.2 V
	Operating current	Icc	—	1.8	2.6	mA	
Error amplifier	Feedback voltage	Vfb	2.472	2.510	2.548	V	FB-COMP short
	Temperature stability	dVfb	—	±80	—	ppm/°C	Ta = –40 to +125°C *1
	Input bias current	Ifb	–0.40	–0.15	–0.05	μA	Measured pin: FB
	Open loop gain	Av	—	65	—	dB	*1
	Upper clamp voltage	Vclamp-comp	3.75	4.10	4.35	V	FB = 2.45 V COMP: Open
	Low voltage	Vl-comp	—	0.1	0.3	V	FB = 3.0 V COMP: Open
	Source current1	Isrc-comp1	–13.5	–10	–6	μA	FB = 1.7 V COMP = 2.5 V
	Source current2	Isrc-comp2	Isrc-comp1 ×3.3	Isrc-comp1 ×3.0	Isrc-comp1 ×2.7	μA	FB = 1.5 V COMP = 2.5 V
	Sink current	Isrc-comp	6	10	13.5	μA	FB = 3.5 V COMP = 2.5 V
Transconductance	gm	25	46	75	μS	FB = 2.45V ↔ 2.55 V COMP = 2.5 V	
RT	RAMP offset voltage	Voff_ramp	—	1.0	—	V	*1
	RAMP amplitude	dVramp	2.90	3.1	3.3	V	*2
	RT voltage	V-rt	2.5	2.6	2.7	V	
	ZCD delay time	Zcd-delay	—	0.87	—	μs	RRT = 200 kΩ *1
	Maximum frequency	fmax	—	500	—	kHz	RRT = 200 kΩ *1
Zero current detector	ZCD threshold voltage	Vzcd	1	3	6	mV	
	Input bias current	Ics	–58	–42	–25	μA	Vcs = 0 V
	CS open detect threshold voltage	Vcs-open	45	72.5	130	mV	
Restart	Restart time delay	Tstart	75	150	330	μs	FB = 2.0 V COMP = 2.5 V

Notes: \*1 Design spec

\*2 dVramp = Vclamp\_comp – Voff\_ramp

**Electrical Characteristics (cont.)**

(Ta = 25°C, VCC = 12 V, CS = 0.04 V, FB = 2 V, COMP: Open, OVP2 = 1 V, RRT = 200 kΩ)

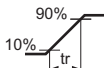
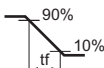
Item		Symbol	Min	Typ	Max	Unit	Test Conditions
Out	Rise time	tr-out	—	35	100	ns	CL = 1000 pF 
	Fall time	tf-out	—	35	100	ns	CL = 1000 pF 
	Out low voltage	Vol1-out	—	0.08	0.2	V	Isink = 20 mA
		Vol2-out	—	0.05	0.7	V	VCC = 5 V, Isink = 10 mA
Out high voltage	Voh-out	11.5	11.8	—	V	Isource = -20 mA	
Over current protection	OCP threshold voltage	Vocp	-0.63	-0.6	-0.57	V	
Over & Under voltage protection	Dynamic OVP threshold voltage	Vdovp	—	Vfb× 1.040	—	V	Measure FB *1
	Dynamic UVP threshold voltage	Vduvp	—	Vfb× 0.920	—	V	*1
	Static OVP threshold voltage	Vsovp	Vfb× 1.075	Vfb× 1.090	Vfb× 1.105	V	
	Static OVP hysteresis	Hys-sovp	50	100	150	mV	
	FB low detect threshold voltage	Vfblow	0.25	0.3	0.35	V	
	FB low detect hysteresis	Hysfblow	0.16	0.20	0.24	V	
	OVP2 high threshold voltage	Vovp2-high	Vfb× 1.18	Vfb× 1.20	Vfb× 1.22	V	Measure OVP2
	OVP2 low threshold voltage	Vovp2-low	0.1	0.2	0.3	V	
OVP2 source current	Isrc-ovp2	-0.40	-0.15	-0.05	μA		

Note: \*1 Design spec

## Waveforms

### 1. Start-up

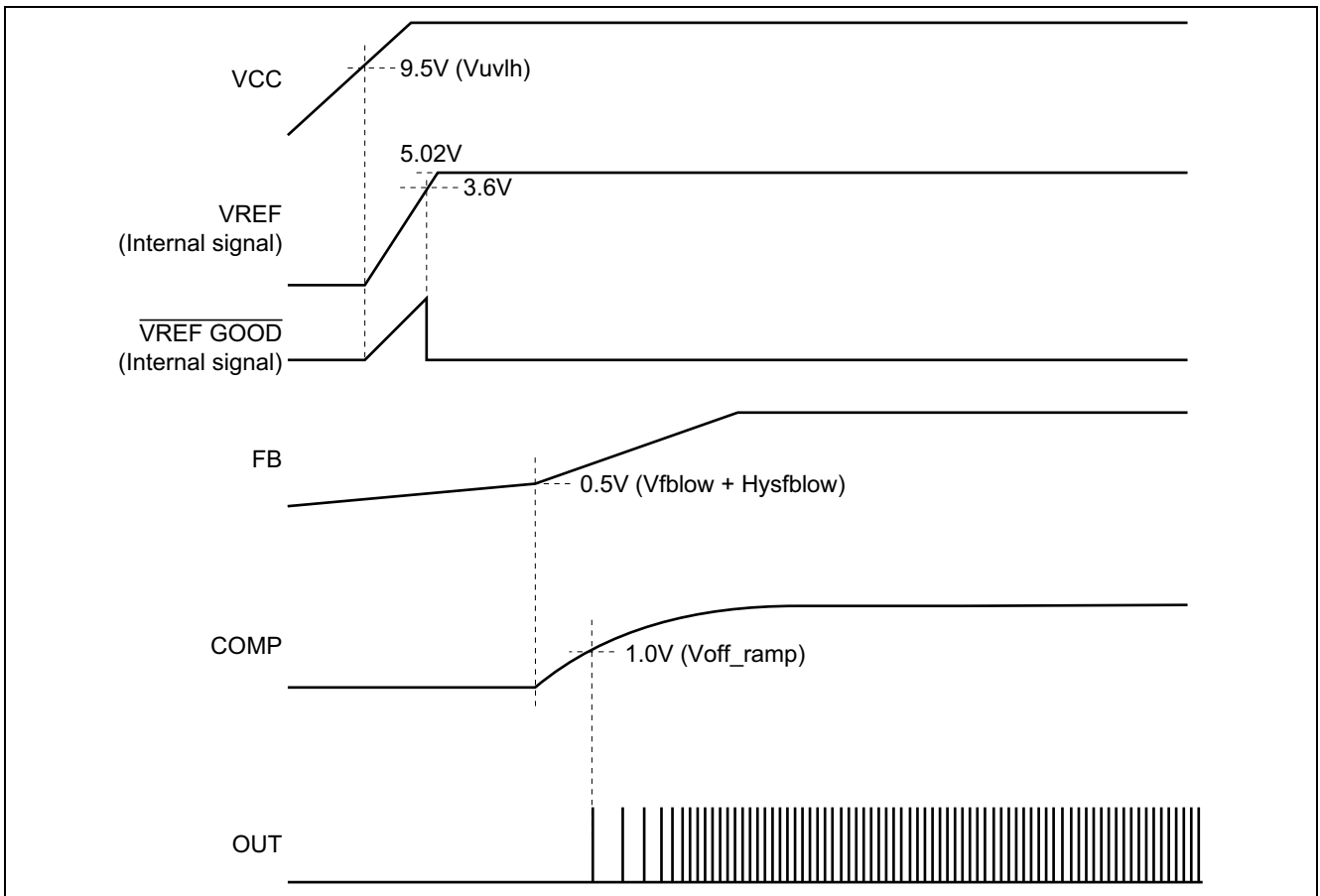

### 2. Shut-down

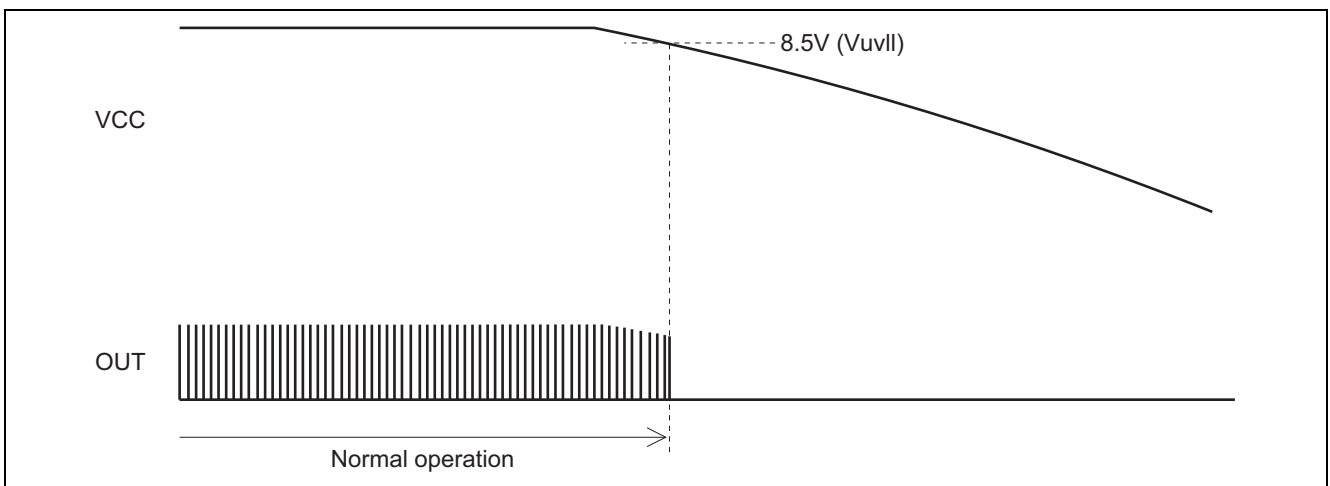



### 3. Gate Drive Output

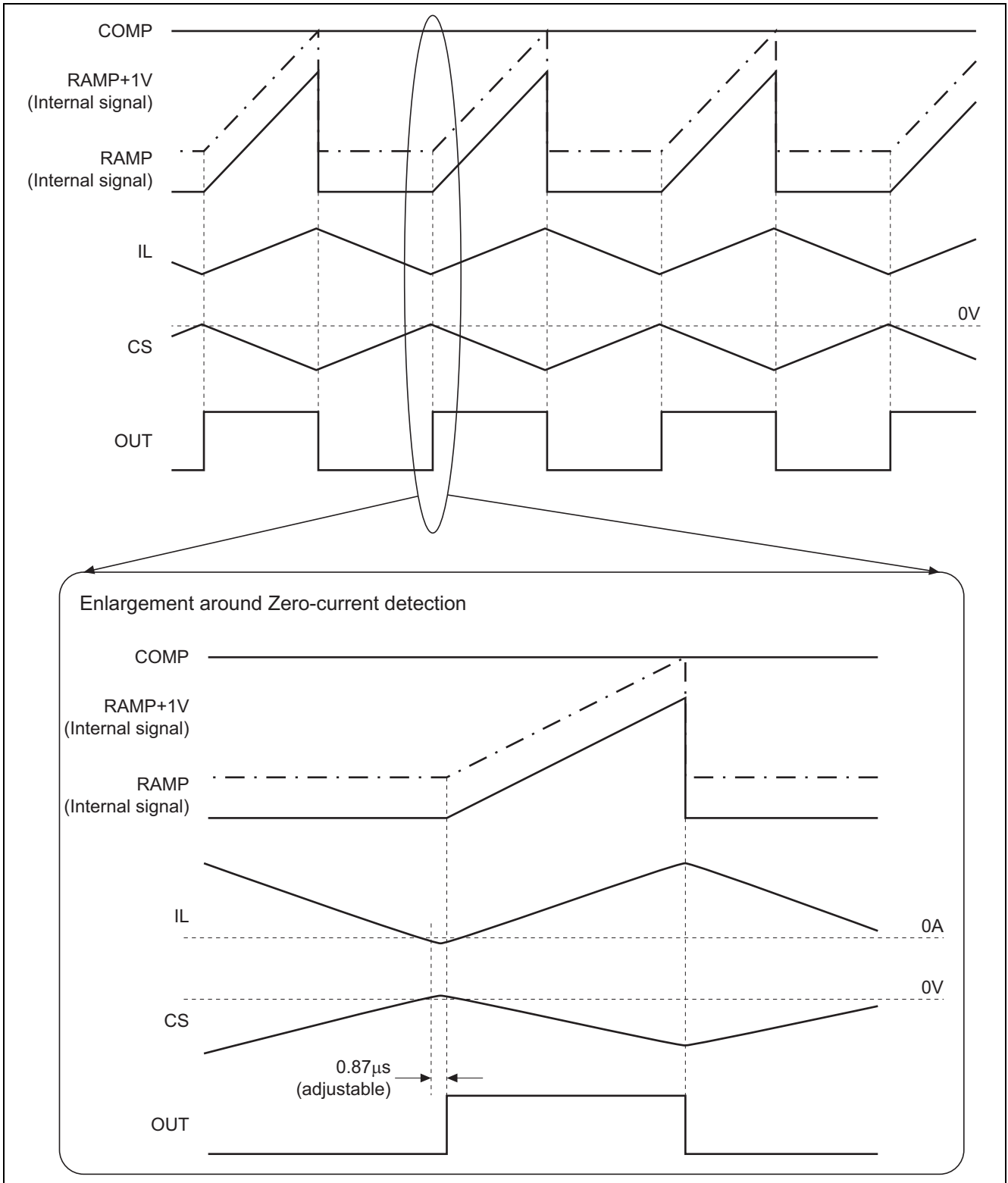

#### 4. Overvoltage Protection (SOVP)

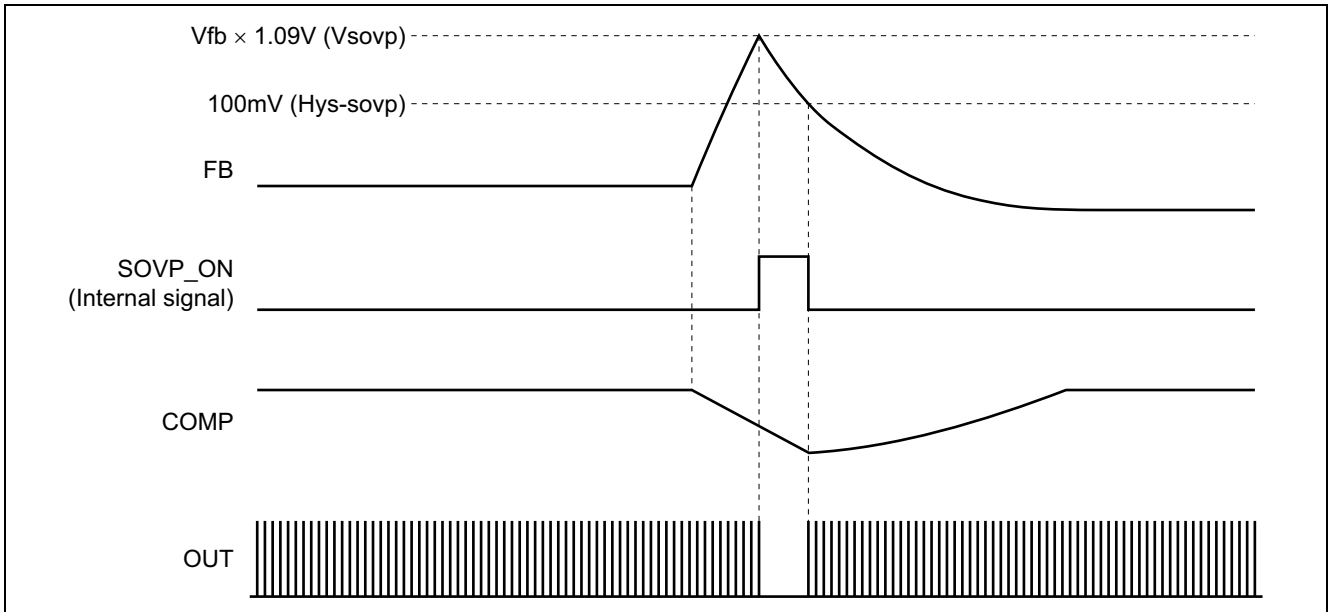

#### 5. FB Low Detection

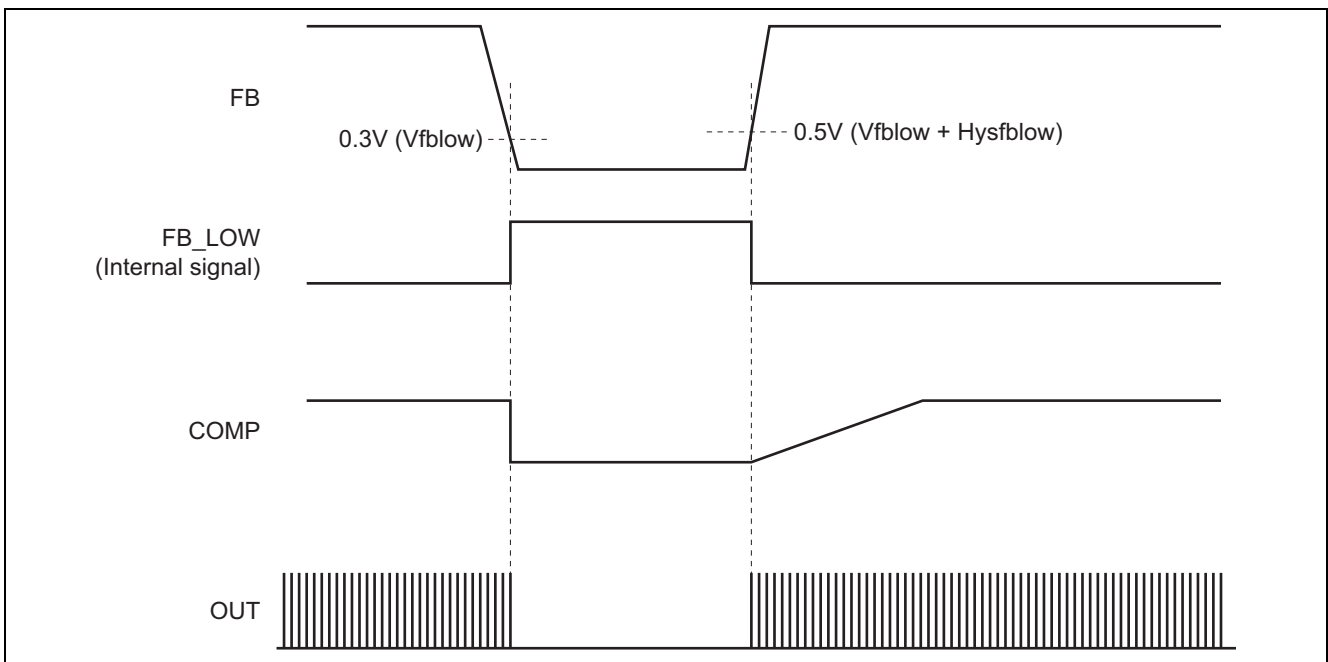

### 6. Overcurrent Protection (OCP)

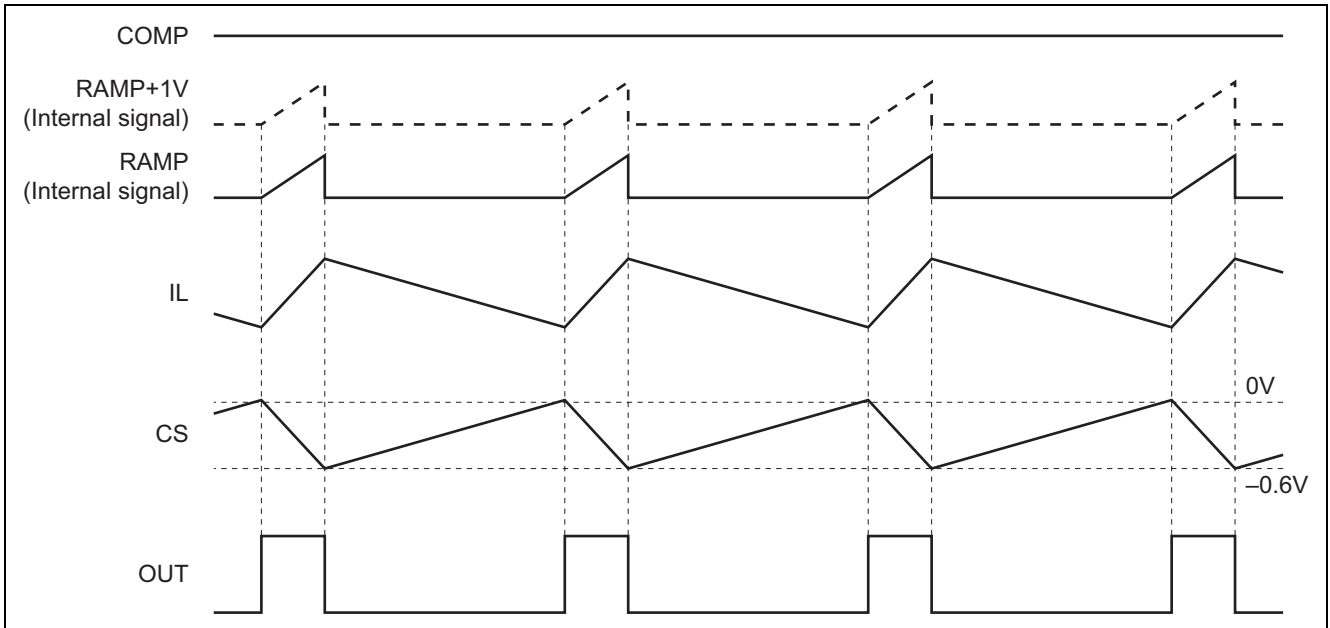

### 7. Frequency Limiter

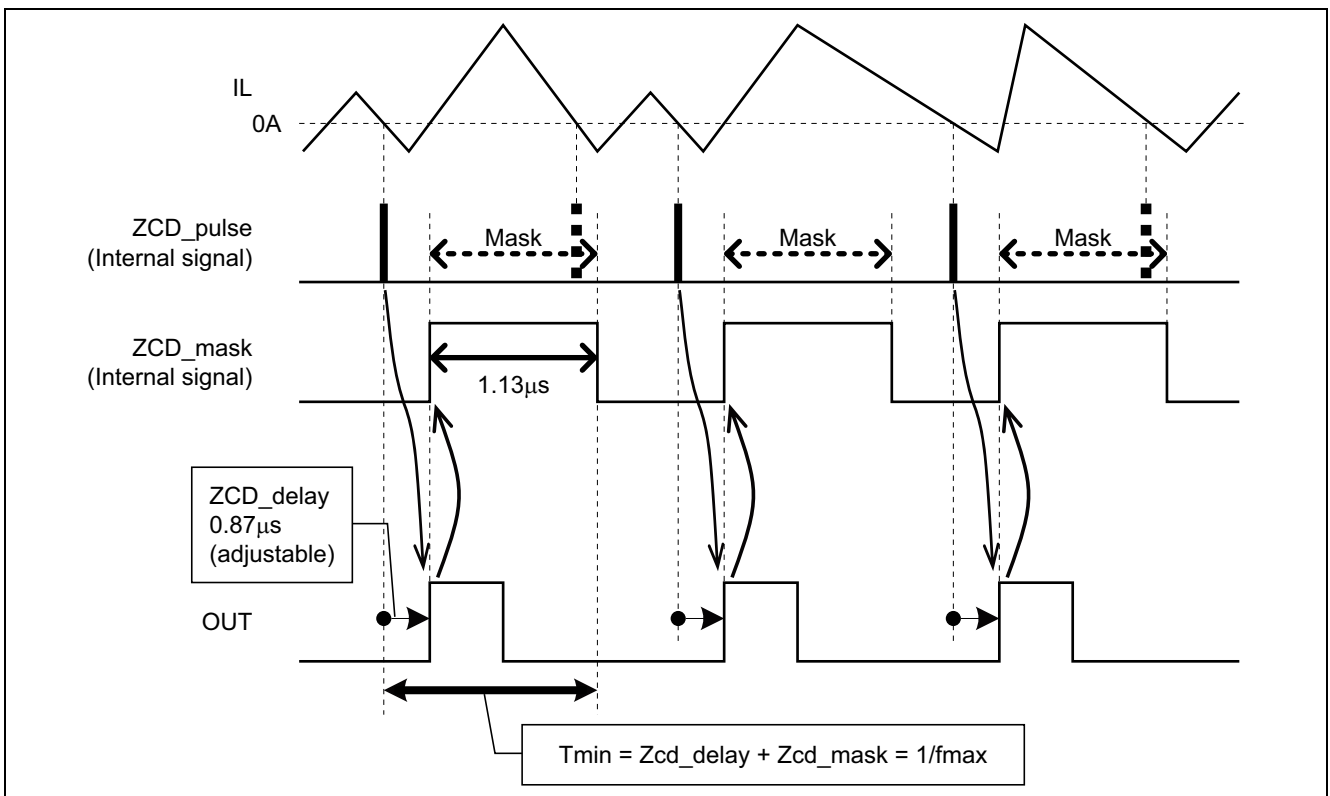

### 8. Overvoltage Protection 2 (OVP2)

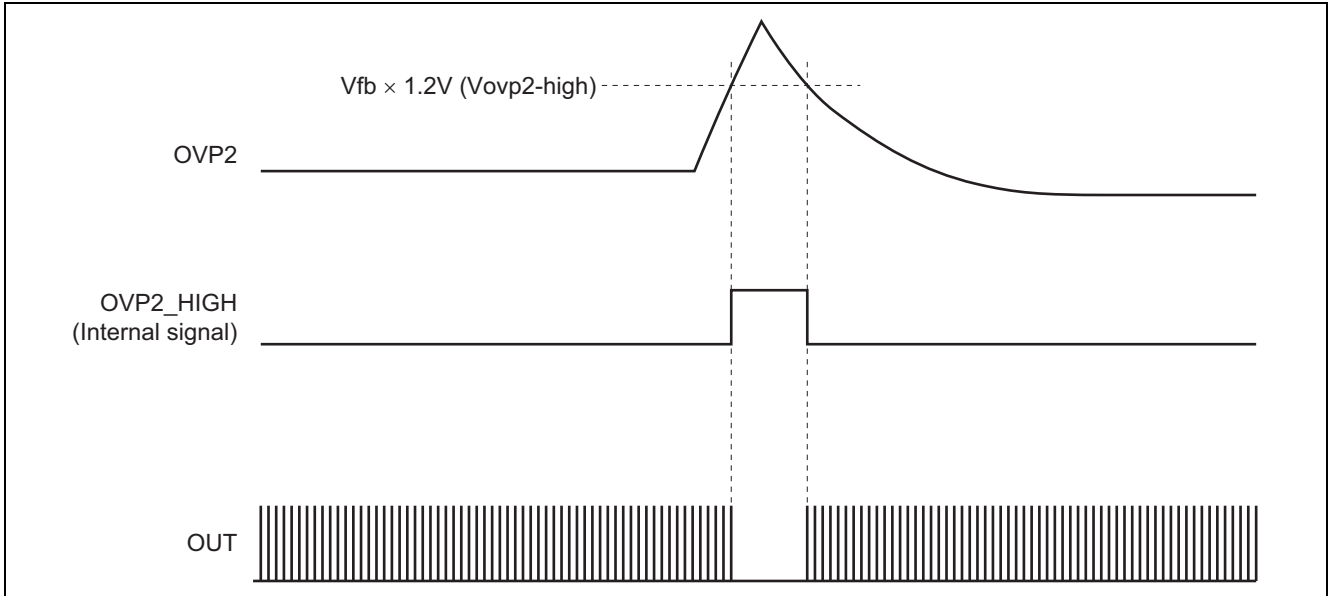

### 9. OVP2 Low Detection

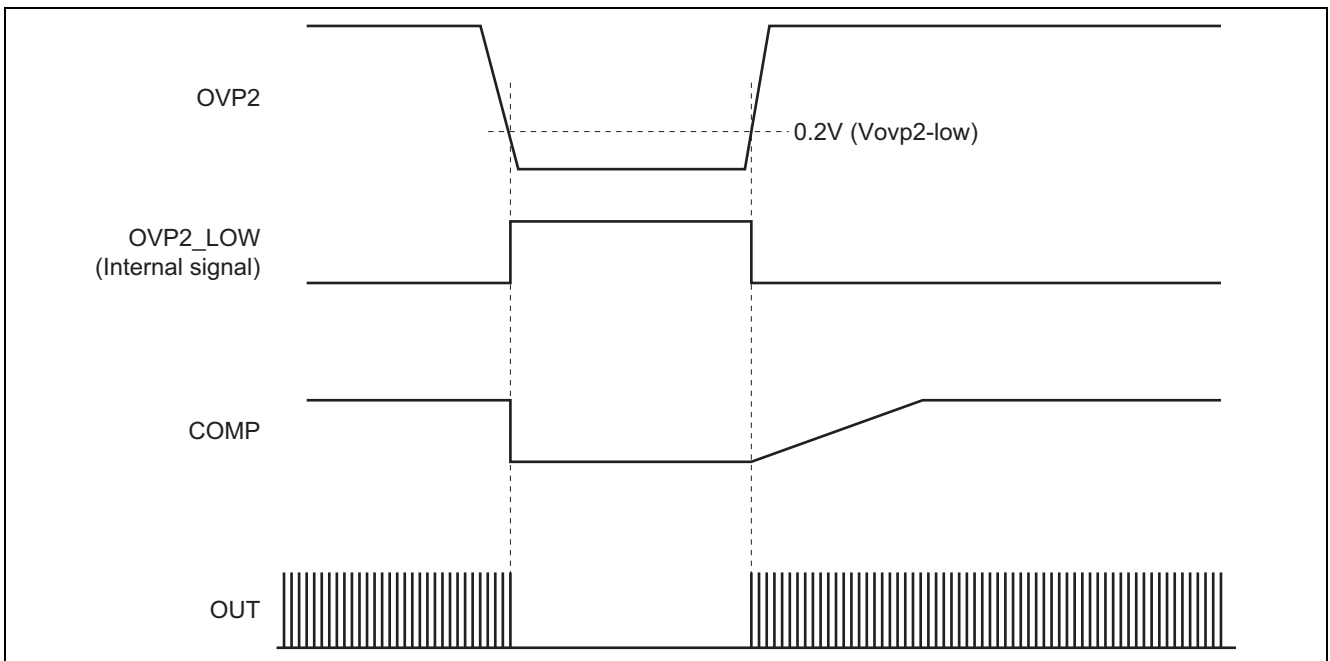

### System Diagram

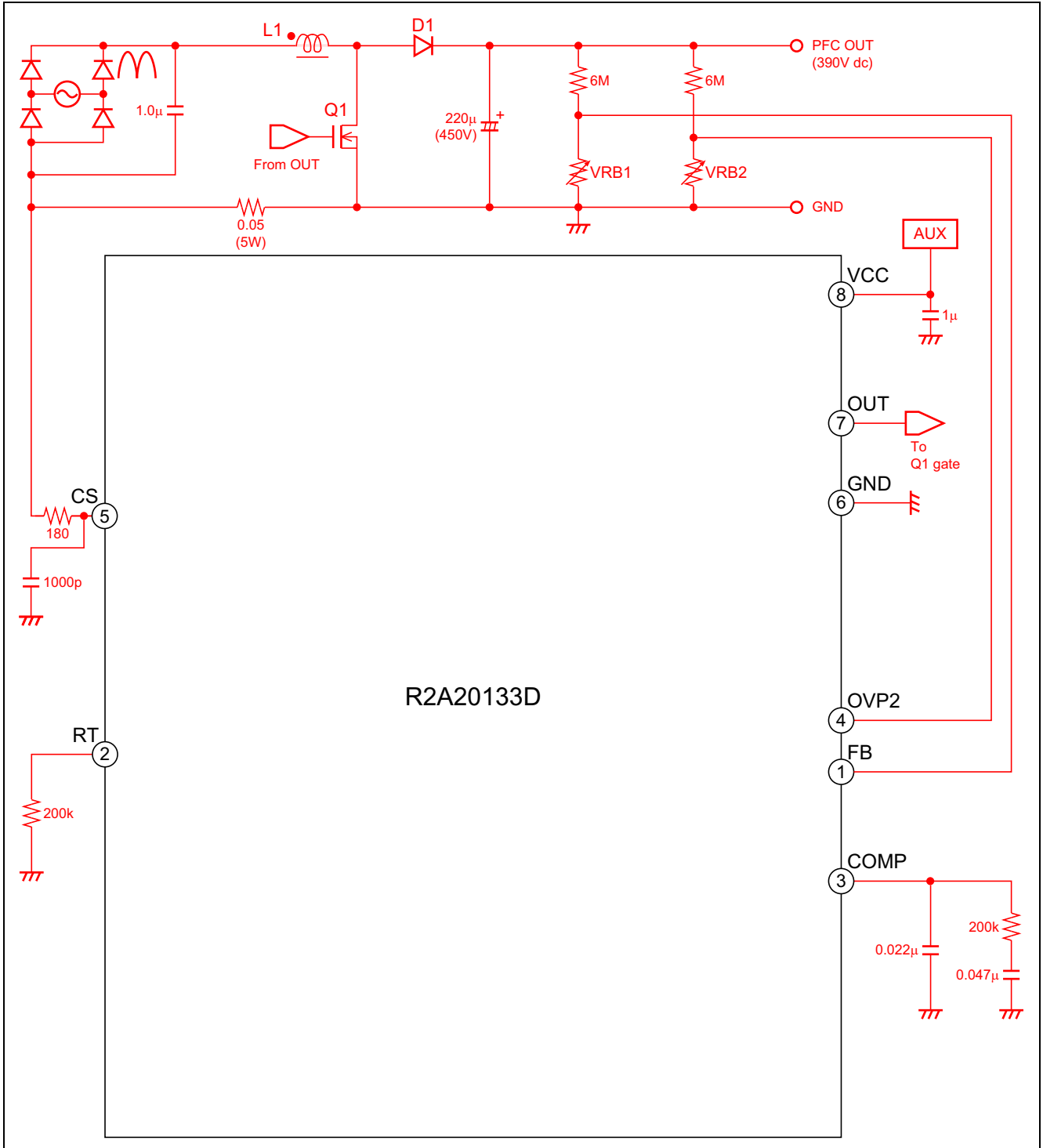

### Package Dimensions

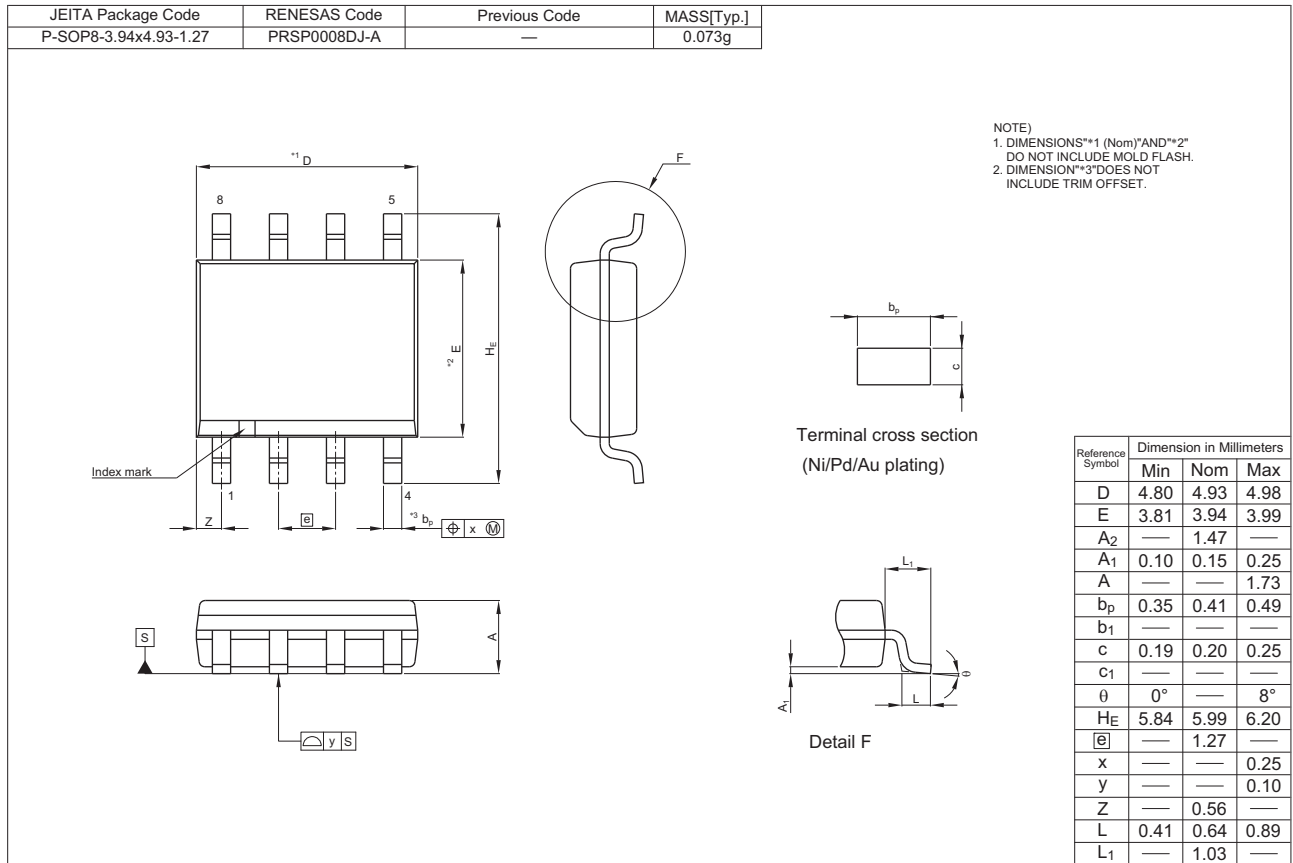

## Notice

1. Descriptions of circuits, software and other related information in this document are provided only to illustrate the operation of semiconductor products and application examples. You are fully responsible for the incorporation of these circuits, software, and information in the design of your equipment. Renesas Electronics assumes no responsibility for any losses incurred by you or third parties arising from the use of these circuits, software, or information.
2. Renesas Electronics has used reasonable care in preparing the information included in this document, but Renesas Electronics does not warrant that such information is error free. Renesas Electronics assumes no liability whatsoever for any damages incurred by you resulting from errors in or omissions from the information included herein.
3. Renesas Electronics does not assume any liability for infringement of patents, copyrights, or other intellectual property rights of third parties by or arising from the use of Renesas Electronics products or technical information described in this document. No license, express, implied or otherwise, is granted hereby under any patents, copyrights or other intellectual property rights of Renesas Electronics or others.
4. You should not alter, modify, copy, or otherwise misappropriate any Renesas Electronics product, whether in whole or in part. Renesas Electronics assumes no responsibility for any losses incurred by you or third parties arising from such alteration, modification, copy or otherwise misappropriation of Renesas Electronics product.
5. Renesas Electronics products are classified according to the following two quality grades: "Standard" and "High Quality". The recommended applications for each Renesas Electronics product depends on the product's quality grade, as indicated below.  
"Standard": Computers; office equipment; communications equipment; test and measurement equipment; audio and visual equipment; home electronic appliances; machine tools; personal electronic equipment; and industrial robots etc.  
"High Quality": Transportation equipment (automobiles, trains, ships, etc.); traffic control systems; anti-disaster systems; anti-crime systems; and safety equipment etc.  
Renesas Electronics products are neither intended nor authorized for use in products or systems that may pose a direct threat to human life or bodily injury (artificial life support devices or systems, surgical implantations etc.), or may cause serious property damages (nuclear reactor control systems, military equipment etc.). You must check the quality grade of each Renesas Electronics product before using it in a particular application. You may not use any Renesas Electronics product for any application for which it is not intended. Renesas Electronics shall not be in any way liable for any damages or losses incurred by you or third parties arising from the use of any Renesas Electronics product for which the product is not intended by Renesas Electronics.
6. You should use the Renesas Electronics products described in this document within the range specified by Renesas Electronics, especially with respect to the maximum rating, operating supply voltage range, movement power voltage range, heat radiation characteristics, installation and other product characteristics. Renesas Electronics shall have no liability for malfunctions or damages arising out of the use of Renesas Electronics products beyond such specified ranges.
7. Although Renesas Electronics endeavors to improve the quality and reliability of its products, semiconductor products have specific characteristics such as the occurrence of failure at a certain rate and malfunctions under certain use conditions. Further, Renesas Electronics products are not subject to radiation resistance design. Please be sure to implement safety measures to guard them against the possibility of physical injury, and injury or damage caused by fire in the event of the failure of a Renesas Electronics product, such as safety design for hardware and software including but not limited to redundancy, fire control and malfunction prevention, appropriate treatment for aging degradation or any other appropriate measures. Because the evaluation of microcomputer software alone is very difficult, please evaluate the safety of the final products or systems manufactured by you.
8. Please contact a Renesas Electronics sales office for details as to environmental matters such as the environmental compatibility of each Renesas Electronics product. Please use Renesas Electronics products in compliance with all applicable laws and regulations that regulate the inclusion or use of controlled substances, including without limitation, the EU RoHS Directive. Renesas Electronics assumes no liability for damages or losses occurring as a result of your noncompliance with applicable laws and regulations.
9. Renesas Electronics products and technology may not be used for or incorporated into any products or systems whose manufacture, use, or sale is prohibited under any applicable domestic or foreign laws or regulations. You should not use Renesas Electronics products or technology described in this document for any purpose relating to military applications or use by the military, including but not limited to the development of weapons of mass destruction. When exporting the Renesas Electronics products or technology described in this document, you should comply with the applicable export control laws and regulations and follow the procedures required by such laws and regulations.
10. It is the responsibility of the buyer or distributor of Renesas Electronics products, who distributes, disposes of, or otherwise places the product with a third party, to notify such third party in advance of the contents and conditions set forth in this document, Renesas Electronics assumes no responsibility for any losses incurred by you or third parties as a result of unauthorized use of Renesas Electronics products.
11. This document may not be reproduced or duplicated in any form, in whole or in part, without prior written consent of Renesas Electronics.
12. Please contact a Renesas Electronics sales office if you have any questions regarding the information contained in this document or Renesas Electronics products, or if you have any other inquiries.

(Note 1) "Renesas Electronics" as used in this document means Renesas Electronics Corporation and also includes its majority-owned subsidiaries.

(Note 2) "Renesas Electronics product(s)" means any product developed or manufactured by or for Renesas Electronics.



### SALES OFFICES

Renesas Electronics Corporation

<http://www.renesas.com>

Refer to "<http://www.renesas.com/>" for the latest and detailed information.

#### Renesas Electronics America Inc.

2801 Scott Boulevard Santa Clara, CA 95050-2549, U.S.A.  
Tel: +1-408-588-6000, Fax: +1-408-588-6130

#### Renesas Electronics Canada Limited

9251 Yonge Street, Suite 8309 Richmond Hill, Ontario Canada L4C 9T3  
Tel: +1-905-237-2004

#### Renesas Electronics Europe Limited

Dukes Meadow, Millboard Road, Bourne End, Buckinghamshire, SL8 5FH, U.K.  
Tel: +44-1628-585-100, Fax: +44-1628-585-900

#### Renesas Electronics Europe GmbH

Arcadiastrasse 10, 40472 Düsseldorf, Germany  
Tel: +49-211-6503-0, Fax: +49-211-6503-1327

#### Renesas Electronics (China) Co., Ltd.

Room 1709, Quantum Plaza, No.27 ZhiChunLu Haidian District, Beijing 100191, P.R.China  
Tel: +86-10-8235-1155, Fax: +86-10-8235-7679

#### Renesas Electronics (Shanghai) Co., Ltd.

Unit 301, Tower A, Central Towers, 555 Langao Road, Putuo District, Shanghai, P. R. China 200333  
Tel: +86-21-2226-0888, Fax: +86-21-2226-0999

#### Renesas Electronics Hong Kong Limited

Unit 1601-1611, 16/F., Tower 2, Grand Century Place, 193 Prince Edward Road West, Mongkok, Kowloon, Hong Kong  
Tel: +852-2265-6688, Fax: +852 2886-9022

#### Renesas Electronics Taiwan Co., Ltd.

13F, No. 363, Fu Shing North Road, Taipei 10543, Taiwan  
Tel: +886-2-8175-9600, Fax: +886 2-8175-9670

#### Renesas Electronics Singapore Pte. Ltd.

80 Bendemeer Road, Unit #06-02 Hyflux Innovation Centre, Singapore 339949  
Tel: +65-6213-0200, Fax: +65-6213-0300

#### Renesas Electronics Malaysia Sdn.Bhd.

Unit 1207, Block B, Menara Amcorp, Amcorp Trade Centre, No. 18, Jln Persiaran Barat, 46050 Petaling Jaya, Selangor Darul Ehsan, Malaysia  
Tel: +60-3-7955-9390, Fax: +60-3-7955-9510

#### Renesas Electronics India Pvt. Ltd.

No.77C, 100 Feet Road, HAL II Stage, Indiranagar, Bangalore, India  
Tel: +91-80-67208700, Fax: +91-80-67208777

#### Renesas Electronics Korea Co., Ltd.

12F., 234 Teheran-ro, Gangnam-Gu, Seoul, 135-080, Korea  
Tel: +82-2-558-3737, Fax: +82-2-558-5141