



Chipsmall Limited consists of a professional team with an average of over 10 year of expertise in the distribution of electronic components. Based in Hongkong, we have already established firm and mutual-benefit business relationships with customers from,Europe,America and south Asia,supplying obsolete and hard-to-find components to meet their specific needs.

With the principle of “Quality Parts,Customers Priority,Honest Operation,and Considerate Service”,our business mainly focus on the distribution of electronic components. Line cards we deal with include Microchip,ALPS,ROHM,Xilinx,Pulse,ON,Everlight and Freescale. Main products comprise IC,Modules,Potentiometer,IC Socket,Relay,Connector.Our parts cover such applications as commercial,industrial, and automotives areas.

We are looking forward to setting up business relationship with you and hope to provide you with the best service and solution. Let us make a better world for our industry!



Contact us

Tel: +86-755-8981 8866 Fax: +86-755-8427 6832

Email & Skype: info@chipsmall.com Web: www.chipsmall.com

Address: A1208, Overseas Decoration Building, #122 Zhenhua RD., Futian, Shenzhen, China



ITEM	Q'TY	PART NUMBER	PART DESCRIPTION
1	1	ORFLP2-XXX	2mm Flexible Light Pipe ORCA Adapter w/ LED
2	1	FLPF-XX.X	Flexible Light Pipe Lens Cap Assembly, Flat

REV.	DESCRIPTION	DATE	APPROVED
A	Engineering Release.	09/14/09	T. Y.
B	Updated Table For Length "X.X"	11/14/12	T. Y.
C	Updated LED Optical Characteristics.	08/29/15	J. C.

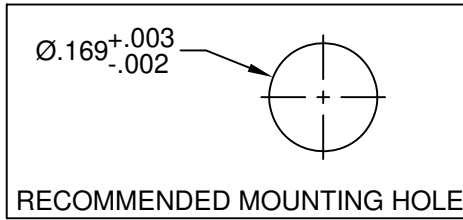
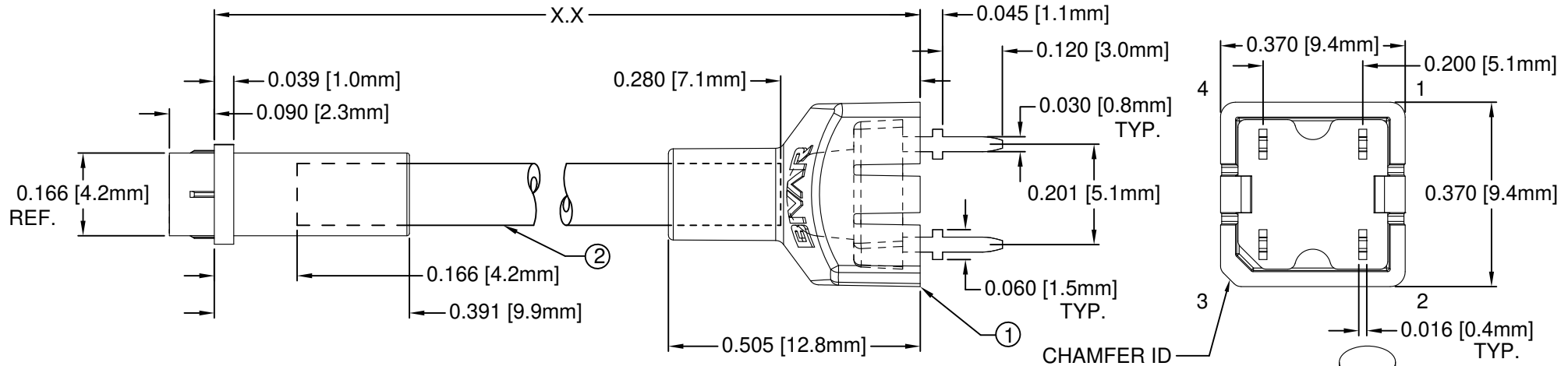

RECOMMENDED MOUNTING HOLE

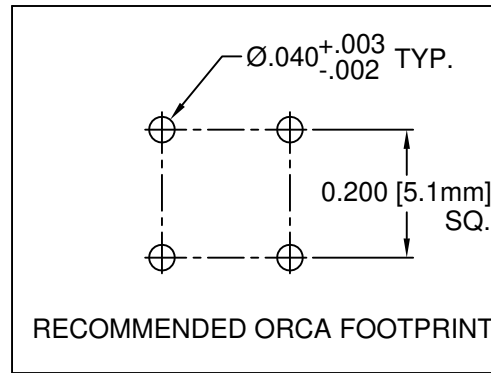

RECOMMENDED ORCA FOOTPRINT

"X.X" *	Tolerance
1.0" ~ 16.0"	±0.050"
16.1" ~ 40.0"	±0.15"
40.1" ~ 80.0"	±0.30"
80.1" ~ 3,940.0"	±0.5%

* Available in 0.1" increments only

NOTE: ORFLP2-XXX ADAPTER SHIPPED SEPARATELY

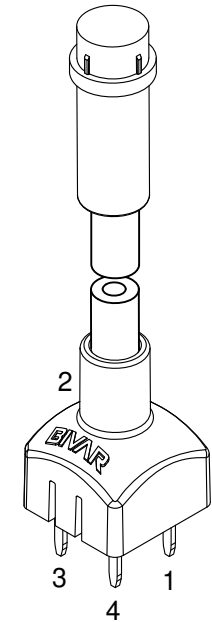

SEE PAGE 2 FOR POLARITY

ABSOLUTE MAXIMUM RATINGS (Ta=25°C)

REVERSE VOLTAGE _____	5V
REVERSE CURRENT _____	10uA
OPERATING TEMPERATURE RANGE _____	-25°C ~ +80°C
STORAGE TEMPERATURE _____	-30°C ~ +80°C
LEAD SOLDERING TEMPERATURE(1/16" FROM BODY) _____	260°C FOR 5 SECONDS

STANDARD TOLERANCE (UNLESS OTHERWISE SPECIFIED)		BIVAR®	
DECIMALS	ANGULAR	4 THOMAS, IRVINE, CA. 92618	
.X ± .2	X° ± 1°	TEL: (949) 951-8808 FAX: (949) 951-3974	
.XX ± .02		TITLE: 2mm FLP ORCA ASSEMBLY, FLAT LENS CAP	
.XXX ± .010		PART NO: R2F-X.X-XXX	
DESIGNED: Raffy Paje	DATE: 09/14/09	REVISION: C	
CHECKED: F. Jensen	DATE: 09/14/09	CAGE CODE : 32559	SHEET # 1 OF 2
CAD GENERATED DOCUMENT. DO NOT MEASURE DRAWING.			

REV.	DESCRIPTION	DATE	APPROVED
	SEE SHEET #1		

Assy P/N	LED P/N	Emitted Color	Dominant Length λ_d (nm) / CCT (K)	Lens Appearance	Absolute Max. Ratings			Vf (V)			Iv (mcd)		Viewing Angle $2\theta_{1/2}$ (Deg)	POLARITY DIAGRAM
					Pd (mW)	If (mA)	Peak If (mA)	MIN	TYP	MAX	MIN	TYP		
SINGLE COLOR LED ASSEMBLIES (20mA)														
R2F-X.X-BLU	R20BLU-4-0045	BLUE	465 - 475	WATER CLEAR	220	50	100	2.7	3.2	3.6	5000	8000	45	FIG. A
R2F-X.X-GRN	R20GRN-4-0045	GREEN	517 - 527		220	50	100	2.7	3.2	3.6	15000	25000	45	FIG. A
R2F-X.X-WHT	R20WHT-4-0045	WHITE	6000K		220	50	100	2.7	3.2	3.6	10000	16000	45	FIG. A
SINGLE COLOR LED ASSEMBLIES (50mA)														
R2F-X.X-RED	R50RED-4-0045	RED	620 - 635	WATER CLEAR	140	80	160	1.8	2.4	2.6	12000	18000	45	FIG. A
R2F-X.X-YLW	R50YLW-4-0045	YELLOW	588 - 596		140	80	160	1.8	2.4	2.6	12000	18000	45	FIG. A
BI-COLOR LED ASSEMBLIES (50mA)														
R2F-X.X-RG	R50RG2-4-0045	RED	617 - 630	WATER CLEAR	150	80	160	1.8	2.4	2.6	3000	4000	45	FIG. B
		GREEN	515 - 525		220	80	150	3.0	3.4	3.8	6000	10000		
R2F-X.X-RB	R50RB2-4-0045	RED	617 - 630	WATER CLEAR	150	80	160	1.8	2.4	2.6	3000	4000	45	FIG. C
		BLUE	460 - 470		220	80	150	3.0	3.4	3.8	1000	3000		
R2F-X.X-BG	R50BG2-4-0045	BLUE	460 - 470	WATER CLEAR	220	80	150	3.0	3.4	3.8	1000	3000	45	FIG. D
		GREEN	515 - 525		220	80	150	3.0	3.4	3.8	6000	10000		
R2F-X.X-RGB	R50RGB-4-0045	RED	617 - 630	WATER CLEAR	150	80	160	1.8	2.4	2.6	3000	4000	45	FIG. E
		GREEN	515 - 525		220	80	150	3.0	3.4	3.8	6000	10000		
		BLUE	460 - 470		220	80	150	3.0	3.4	3.8	1000	3000		

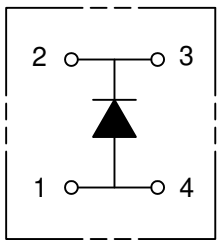

FIG. A

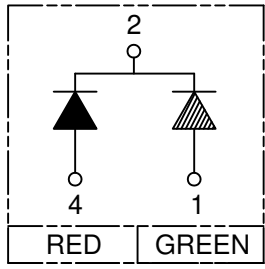

FIG. B

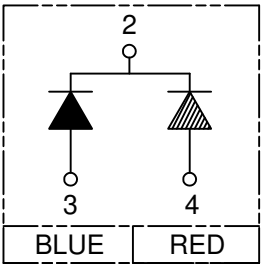

FIG. C

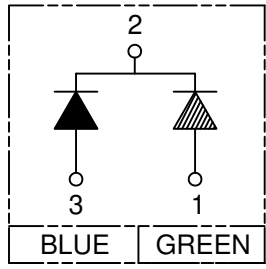

FIG. D

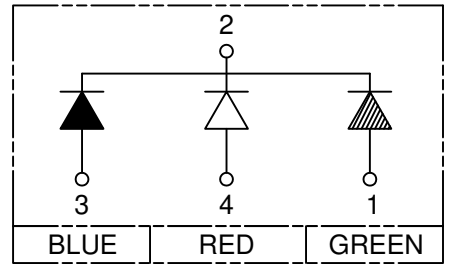

FIG. E

NOTES:
1. INDIVIDUAL LED P/N DATA AVAILABLE @ WWW.BIVAR.COM.

STANDARD TOLERANCE (UNLESS OTHERWISE SPECIFIED) DECIMALS ANGULAR		BIVAR [®] 4 THOMAS, IRVINE, CA. 92618 TEL: (949) 951-8808 FAX: (949) 951-3974	
DESIGNED: Raffy Paje	DATE: 09/14/09	TITLE: 2mm FLP ORCA ASSEMBLY, FLAT LENS CAP	
CHECKED: F. Jensen	DATE: 09/14/09	PART NO: R2F-X.X-XXX	REVISION: C
		CAGE CODE : 32559	SHEET # 2 OF 2
CAD GENERATED DOCUMENT. DO NOT MEASURE DRAWING.			