



Chipsmall Limited consists of a professional team with an average of over 10 year of expertise in the distribution of electronic components. Based in Hongkong, we have already established firm and mutual-benefit business relationships with customers from,Europe,America and south Asia,supplying obsolete and hard-to-find components to meet their specific needs.

With the principle of “Quality Parts,Customers Priority,Honest Operation,and Considerate Service”,our business mainly focus on the distribution of electronic components. Line cards we deal with include Microchip,ALPS,ROHM,Xilinx,Pulse,ON,Everlight and Freescale. Main products comprise IC,Modules,Potentiometer,IC Socket,Relay,Connector.Our parts cover such applications as commercial,industrial, and automotives areas.

We are looking forward to setting up business relationship with you and hope to provide you with the best service and solution. Let us make a better world for our industry!



Contact us

Tel: +86-755-8981 8866 Fax: +86-755-8427 6832

Email & Skype: info@chipsmall.com Web: www.chipsmall.com

Address: A1208, Overseas Decoration Building, #122 Zhenhua RD., Futian, Shenzhen, China



RHYTHM R3920

Preconfigured DSP System for Hearing Aids

Description

RHYTHM™ R3920 is a preconfigured hearing health processor based on a DSP platform. Featuring 16 channels of Wide Dynamic Range Compression and Impulse Noise Reduction, R3920 encompasses a rich set of advanced sound processing algorithms and is ideal for high end, full-featured hearing aids. The R3920 hybrid is available in one of the industry's smallest form-factors and is well-suited for all hearing aid types, including those placed deep in the ear canal.

Features and Benefits

Wide Dynamic Range Compression (WDRC) – R3920 contains 16 Channels of Wide Dynamic Range Compression, each with individual settings for Squelch Attenuation and Threshold, Low Level Gain, High Level Gain, Upper and Lower Thresholds, and Compression Ratio. Independent level detectors for both Squelch and WDRC are available with customizable attack and release times set in each channel.

Impulse Noise Reduction (INR) – Loud, impulsive sounds in the environment such as slamming doors, dropped items, or clattering dishes can become uncomfortably or dangerously loud in a traditional hearing aid. The INR algorithm actively monitors and processes the incoming acoustic signal for such sounds. It ensures that the output sound preserves the integrity of the speech signal and is descriptive of the environment, while maintaining an optimal comfort level for the hearing aid user.

Acoustic Environment Classification – iSceneDetect™ analyzes incoming acoustic signals in order to determine the appropriate classification for a given acoustic environment. Six separate environments are supported by iSceneDetect: quiet, speech in quiet, noise, speech in noise, music, and wind. The feature uses this classification to automatically adjust settings of other features for optimum audio performance.

iLog™ 4.0 Datalogging – Enables the recording of various hearing aid parameters such as program selection, volume setting and ambient sound levels. The sampling interval can be configured to record from every 4 seconds up to once every 60 minutes. The manufacturer can program the fitting system to retrieve the data for further analysis after an extensive period of wearing the hearing aid. This allows the audiologist to fine tune the hearing aid and further counsel the end-user.

Automatic Adaptive Directionality – The Automatic Adaptive Directional Microphone (ADM) algorithm automatically reduces the level of sound sources that originate from behind or to the side of the hearing aid wearer without affecting sounds from the front. The algorithm can also gather input from the acoustic iSceneDetect environmental classifier algorithm and automatically select whether directionality is needed or not, translating into additional current savings.



ON Semiconductor®

www.onsemi.com

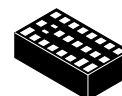

25 PAD
HYBRID
CASE 127DN

PAD CONNECTION

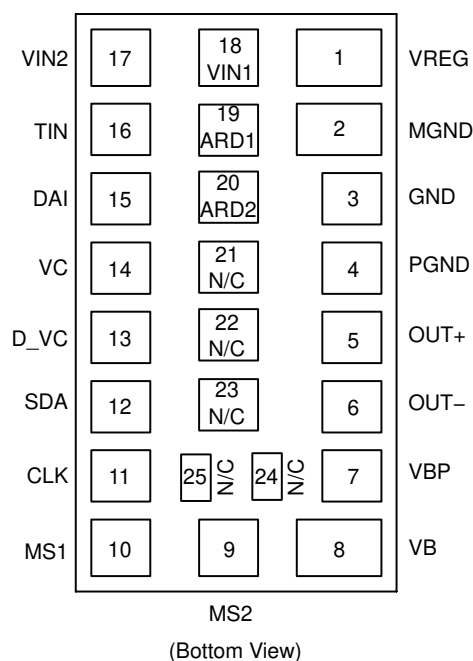

MARKING DIAGRAM

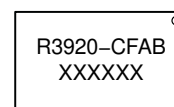

R3920-CFAB = Specific Device Code
XXXXXX = Work Order Number

ORDERING INFORMATION

See detailed ordering and shipping information on page 9 of this data sheet.

RHYTHM R3920

Adaptive Feedback Cancellor – Automatically reduces acoustic feedback. It allows for an increase in the stable gain while minimizing artifacts for music and tonal input signals. Additional tuning parameters make for more precise tuning of the algorithm to the hearing aid. The development tools for the R3920 offer a special calibration module to help assess the maximum stable gain in the hearing aid the manufacturer has built to further optimize the Adaptive Feedback Cancellor algorithm.

Adaptive Noise Reduction – The Adaptive Noise Reduction algorithm monitors noise levels independently in 128 individual bands and employs advanced psychoacoustic models to reduce noise and provide user comfort. The algorithm can be set for varying levels of aggressiveness from 3 dB up to 12 dB.

Automatic Receiver Detection – For Receiver-in-Canal (RIC) devices with field replaceable receivers, R3920 allows manufacturers to code different receiver types so they are automatically recognizable in software, eliminating potential selection errors.

Tinnitus Masking – R3920 is equipped with a noise source that can be used to mask tinnitus. The noise can be shaped and attenuated and then summed into the audio path either before or after the volume control. A white noise signal is generated and inserted into the audio path either before or after the volume control. Filtering can be performed on the white noise signal in order to shape the noise signal to a desired frequency and bandwidth. The tinnitus masker can be used as a stand alone tinnitus making device or as part of a hearing aid.

EVOKE™ Advanced Acoustic Indicators – Allows hearing aid manufacturers to provide more pleasing, multi-frequency tones simulating musical notes or chords to indicate events such as program or volume changes.

In-situ Tone Generator – The narrow-band noise stimulus feature can be used for in-situ validation of the hearing aid fitting. The frequency, level and duration of the stimuli are individually adjustable.

Other Key Features – R3920 also supports the following features: FrontWave® directional processing, built-in feedback path measurement, cross fading between audio paths for click-free program changes, 16-band graphic equalizer, 8 generic biquad filters (configurable as parametric or other filter types), programming speed enhancements, optional peak clipping, flexible compression adjustments, direct interfaces to analog or digital volume control, rocker switch, direct audio input and telecoil. Rhythm R3920 also encompasses industry-leading security features to avoid cloning and software piracy.

Support Tools

- Hybrid Jig
- DSP3 Programming Box
- ARK Software Support

Features

- 16 Channel WDRC
- Advanced Research Algorithms:
 - ◆ Impulse Noise Reduction (INR)
 - ◆ iSceneDetect Environmental Classification
 - ◆ Automatic Adaptive Directional Microphones (ADM)
 - ◆ FrontWave Directionality
 - ◆ 128-band Adaptive Noise Reduction
 - ◆ Next-Generation Adaptive Feedback Cancellation (AFC)
- iLog 4.0 Datalogging
- Tinnitus Masking Noise Generator
- Evoke Acoustic Indicators
- Auto Telecoil with Programmable Delay
- Feedback Path Measurement Tool
- AGC-O with Variable Threshold, Time Constants, and Optional Adaptive Release
- 16-band Graphic Equalizer
- Narrow-Band Noise Stimulus
- SDA or I²C Programming
- 8 Biquadratic Filters
- 4 Analog Inputs
- 16 kHz or 8 kHz Bandwidth
- 6 Fully Configurable Memories with Audible Memory Change Indicator
- 96 dB Input Dynamic Range with HRX™ Headroom Extension
- 128-bit Fingerprint Security System and Other Security Features to Protect Against Device Cloning and Software Piracy
- High Fidelity Audio CODEC
- Soft Acoustic Fade between Memory Changes
- Drives Zero-Bias 2-Terminal Receivers
- Internal or External Digital Volume Control with Programmable Range
- Digital Volume Control Level Retention After Power Cycle
- Rocker Switch Support
- Support for Active Hi or Active Lo Switching
- 20-bit Audio Processing
- thinSTAX® Packaging
- E1 RoHS Compliant Hybrid
- These Devices are Pb-Free and are RoHS Compliant

Packaging Information

- Hybrid Typical Dimensions:
0.220 x 0.125 x 0.060 in.
(5.59 x 3.18 x 1.52 mm)

RHYTHM R3920

BLOCK DIAGRAM

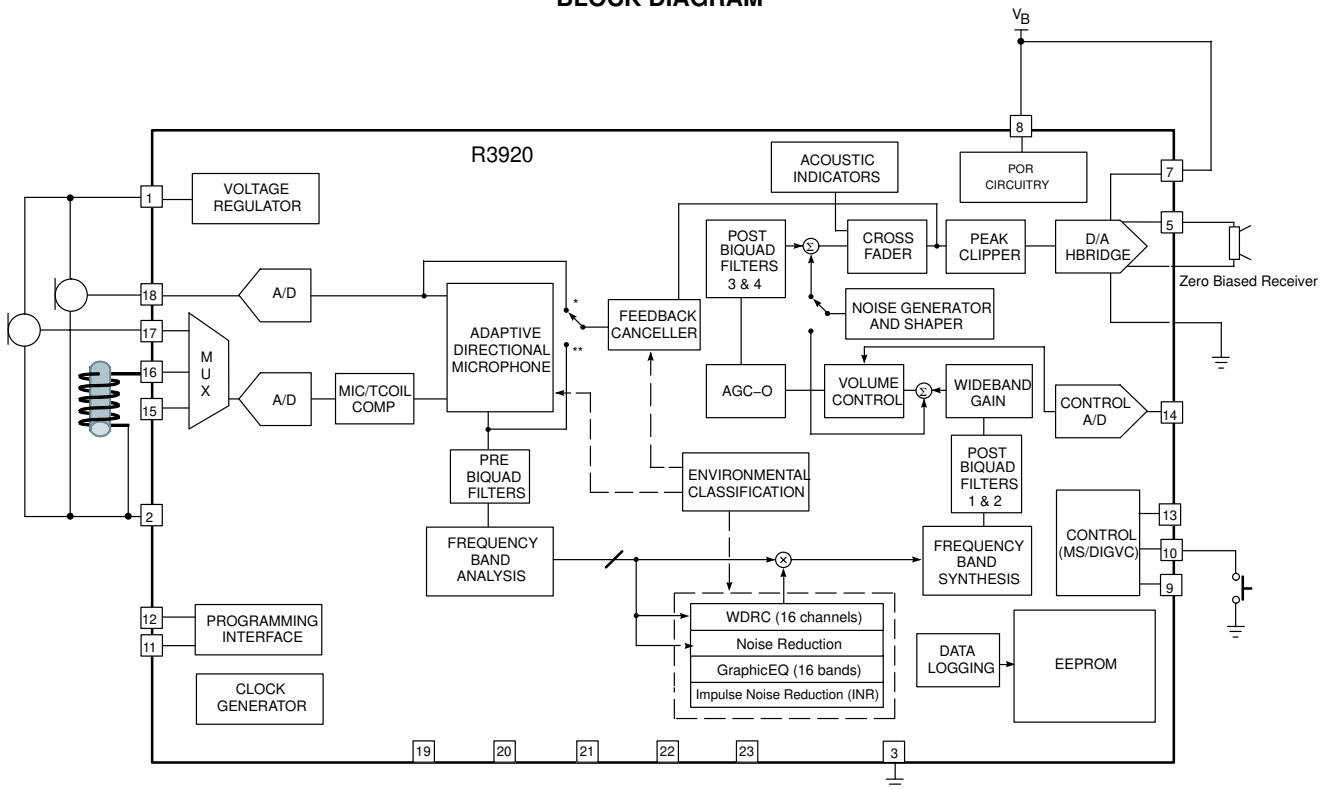

Figure 1. Hybrid Block Diagram

RHYTHM R3920

SPECIFICATIONS

Table 1. ABSOLUTE MAXIMUM RATINGS

Parameter	Value	Units
Operating Temperature Range	0 to +40	°C
Storage Temperature Range	-20 to +70	°C
Absolute Maximum Power Dissipation	50	mW
Maximum Operating Supply Voltage	1.65	VDC
Absolute Maximum Supply Voltage	1.8	VDC

Stresses exceeding those listed in the Maximum Ratings table may damage the device. If any of these limits are exceeded, device functionality should not be assumed, damage may occur and reliability may be affected.

WARNING: Electrostatic Sensitive Device – Do not open packages or handle except at a static-free workstation.

WARNING: Moisture Sensitive Device – RoHS Compliant; Level 4 MSL. Do not open packages except under controlled conditions.

Table 2. ELECTRICAL CHARACTERISTICS (Supply Voltage $V_B = 1.25$ V; Temperature = 25°C)

Parameter	Symbol	Conditions	Min	Typ	Max	Units
Minimum Operating Supply Voltage	V_{BOFF}	Ramp down, audio path	0.93	0.95	0.97	V
		Ramp down, control logic	0.77	0.80	0.83	
Supply Voltage Turn On Threshold	V_{BON}	Ramp up, zinc-air	1.06	1.10	1.16	V
		Ramp up, NiMH	1.16	1.20	1.24	
Hybrid Current		All functions, 32 kHz sampling rate	-	730	-	µA
		All functions, 16 kHz sampling rate	-	620	-	
EEPROM Burn Cycles	-	-	100 k	-	-	cycles
Low Frequency System Limit	-	-	-	125	-	Hz
High Frequency System Limit	-	-	-	16	-	kHz
Total Harmonic Distortion	THD	$V_{IN} = -40$ dBV	-	-	1	%
THD at Maximum Input	THD _M	$V_{IN} = -15$ dBV, HRX – ON	-	-	3	%
Clock Frequency	f_{CLK}	-	3.973	4.096	4.218	MHz

REGULATOR

Regulator Voltage	V_{REG}	-	0.87	0.90	0.93	V
System PSRR	PSRR _{SYS}	1 kHz, Input referred, HRX enabled	-	70	-	dB

INPUT

Input Referred Noise	IRN	Bandwidth 100 Hz – 8 kHz	-	-108	-106	dBV
Input Impedance	Z_{IN}	1 kHz	-	3	-	MΩ
Anti-aliasing Filter Rejection	-	$f = [DC - 112$ kHz], $V_{IN} = -40$ dBV	-	80	-	dB
Crosstalk	-	Between both A/D and Mux	-	60	-	dB
Maximum Input Level	-	-	-	-15	-13	dBV
Analogue Input Voltage Range	V_{AN_IN}	V_{IN1}, V_{IN2}, AI	0	-	800	mV
	V_{AN_TIN}	T_{IN}	-100	-	800	
Input Dynamic Range	-	HRX – ON Bandwidth 100 Hz – 8 kHz	-	95	96	dB
Audio Sampling Rate	-	-	8	-	48	kHz

OUTPUT

D/A Dynamic Range	-	100 Hz – 8 kHz	-	88	-	dB
Output Impedance	Z_{OUT}	-	-	10	13	Ω

RHYTHM R3920

Table 2. ELECTRICAL CHARACTERISTICS (Supply Voltage $V_B = 1.25\text{ V}$; Temperature = 25°C)

Parameter	Symbol	Conditions	Min	Typ	Max	Units
CONTROL A/D						
Resolution (monotonic)	–	–	7	–	–	bits
Zero Scale Level	–	–	–	0	–	V
Full Scale Level	–	–	–	V_{REG}	–	V
VOLUME CONTROL						
Volume Control Resistance	R_{VC}	Three-terminal connection	200	–	1000	$k\Omega$
Volume Control Range	–	–	–	–	42	dB
PC_SDA INPUT						
Logic 0 Voltage	–	–	0	–	0.3	V
Logic 1 Voltage	–	–	1	–	1.25	V
PC_SDA OUTPUT						
Stand-by Pull Up Current	–	Creftrim = 6	3	5	6.5	μA
Sync Pull Up Current	–	Creftrim = 6	748	880	1020	μA
Max Sync Pull Up Current	–	Creftrim = 15	–	1380	–	μA
Min Sync Pull Up Current	–	Creftrim = 0	–	550	–	μA
Logic 0 Current (Pull Down)	–	Creftrim = 6	374	440	506	μA
Logic 1 Current (Pull Up)	–	Creftrim = 6	374	440	506	μA
Synchronization Time (Synchronization Pulse Width)	T_{SYNC}	Baud = 0	237	250	263	μs
		Baud = 1	118	125	132	
		Baud = 2	59	62.5	66	
		Baud = 3	29.76	31.25	32.81	
		Baud = 4	14.88	15.63	16.41	
		Baud = 5	7.44	7.81	8.20	
		Baud = 6	3.72	3.91	4.10	
		Baud = 7	1.86	1.95	2.05	

Product parametric performance is indicated in the Electrical Characteristics for the listed test conditions, unless otherwise noted. Product performance may not be indicated by the Electrical Characteristics if operated under different conditions.

RHYTHM R3920

Table 3. I²C TIMING

Parameter	Symbol	Standard Mode		Fast Mode		Units
		Min	Max	Min	Max	
Clock Frequency	f _{PC_CLK}	0	100	0	400	kHz
Hold time (repeated) START condition. After this period, the first clock pulse is generated.	t _{HD;STA}	4.0	–	0.6	–	μsec
LOW Period of the PC_CLK Clock	t _{LOW}	4.7	–	–	–	μsec
HIGH Period of the PC_CLK Clock	t _{HIGH}	4.0	–	–	–	μsec
Set-up time for a repeated START condition	t _{SU;STA}	4.7	–	–	–	μsec
Data Hold Time: for CBUS Compatible Masters for I ² C-bus Devices	t _{HD;DAT}	5.0 0 (Note 1)	– 3.45 (Note 2)	– 0 (Note 1)	– 0.9 (Note 2)	μsec
Data set-up time	t _{SU;DAT}	250	–	100	–	nsec
Rise time of both PC_SDA and PC_CLK signals	t _r	–	1000	20 + 0.1 C _b (Note 4)	300	nsec
Fall time of both PC_SDA and PC_CLK signals	t _f	–	300	20 + 0.1 C _b (Note 4)	300	nsec
Set-up time for STOP condition	t _{SU;STO}	4.0	–	0.6	–	nsec
Bus free time between a STOP and START condition	t _{BUF}	4.7	–	1.3	–	μsec
Output fall time from V _{IHmin} to V _{ILmax} with a bus capacitance from 10 pF to 400 pF	t _{of}	–	250	20 + 0.1 C _b	250	nsec
Pulse width of spikes which must be suppressed by the input filter	t _{SP}	n/a	n/a	0	50	nsec
Capacitive load for each bus line	C _b	–	400	–	400	pF

1. A device must internally provide a hold time of at least 300 ns for the PC_SDA signal to bridge the undefined region of the falling edge of PC_CLK.
2. The maximum t_{HD;DAT} has only to be met if the device does not stretch the LOW period (t_{LOW}) of the PC_CLK signal.
3. A Fast-mode I²C-bus device can be used in a Standard-mode I²C-bus system, but the requirement t_{SU;DAT} ≥ 250ns must then be met. This will automatically be the case if the device does not stretch the LOW period of the PC_CLK signal. If such a device does stretch the LOW period of the PC_CLK signal, it must output the next data bit to the PC_SDA line t_r max + t_{SU;DAT} = 1000 + 250 = 1250 ns (according to the Standard-mode I²C-bus specification) before the PC_CLK line is released.
4. C_b = total capacitance of one bus line in pF.

RHYTHM R3920

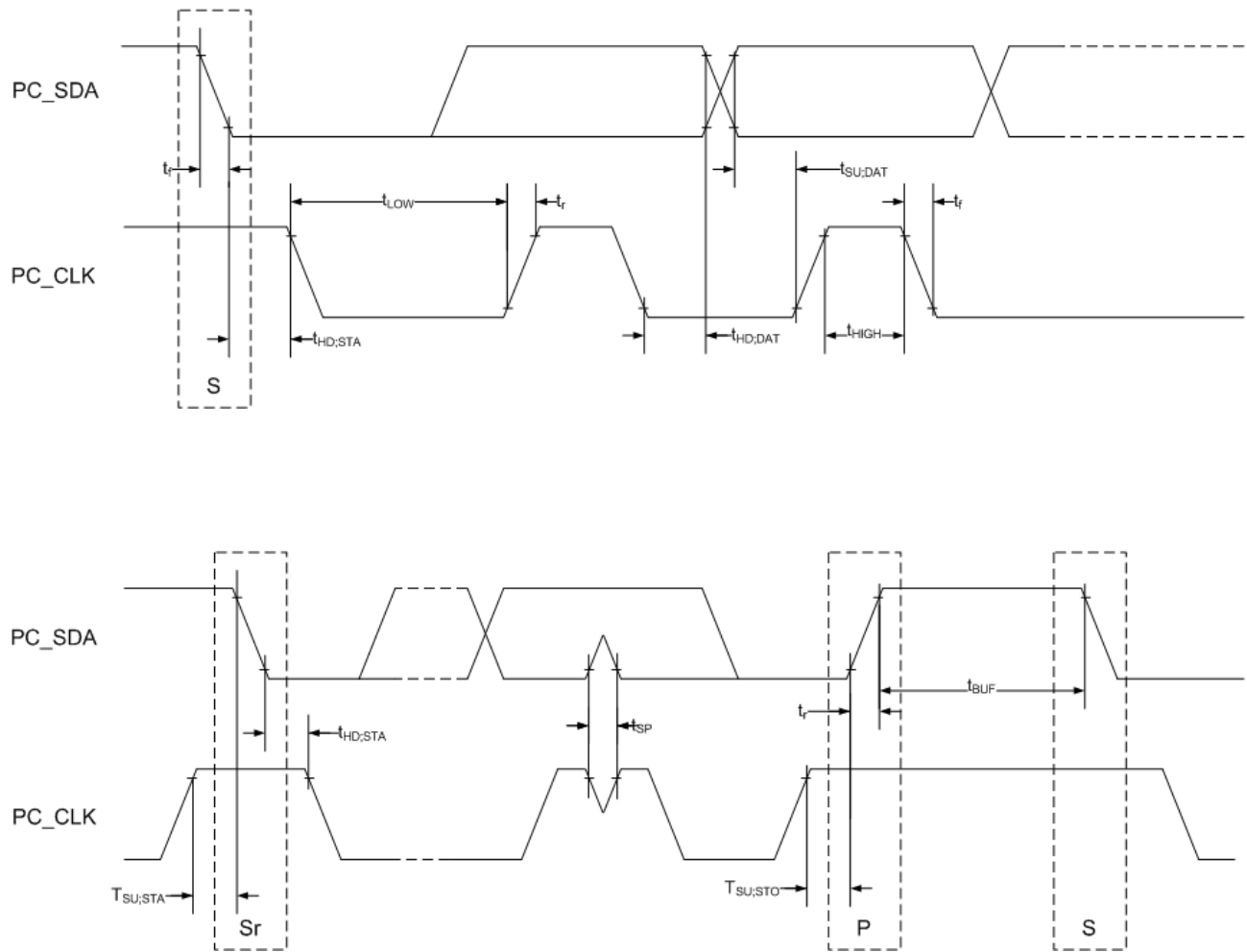

Figure 2. I²C Mode Timing

RHYTHM R3920

TYPICAL APPLICATIONS

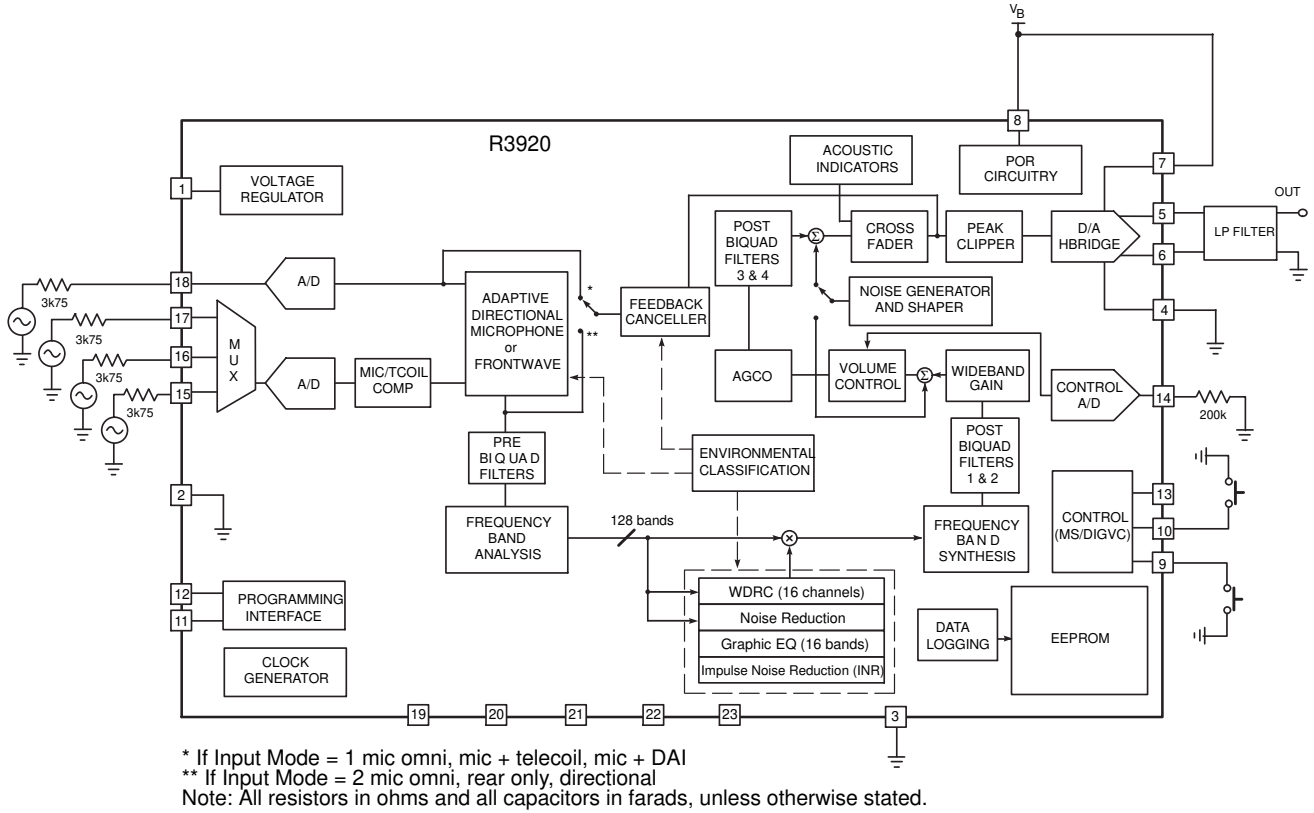

Figure 3. Test Circuit

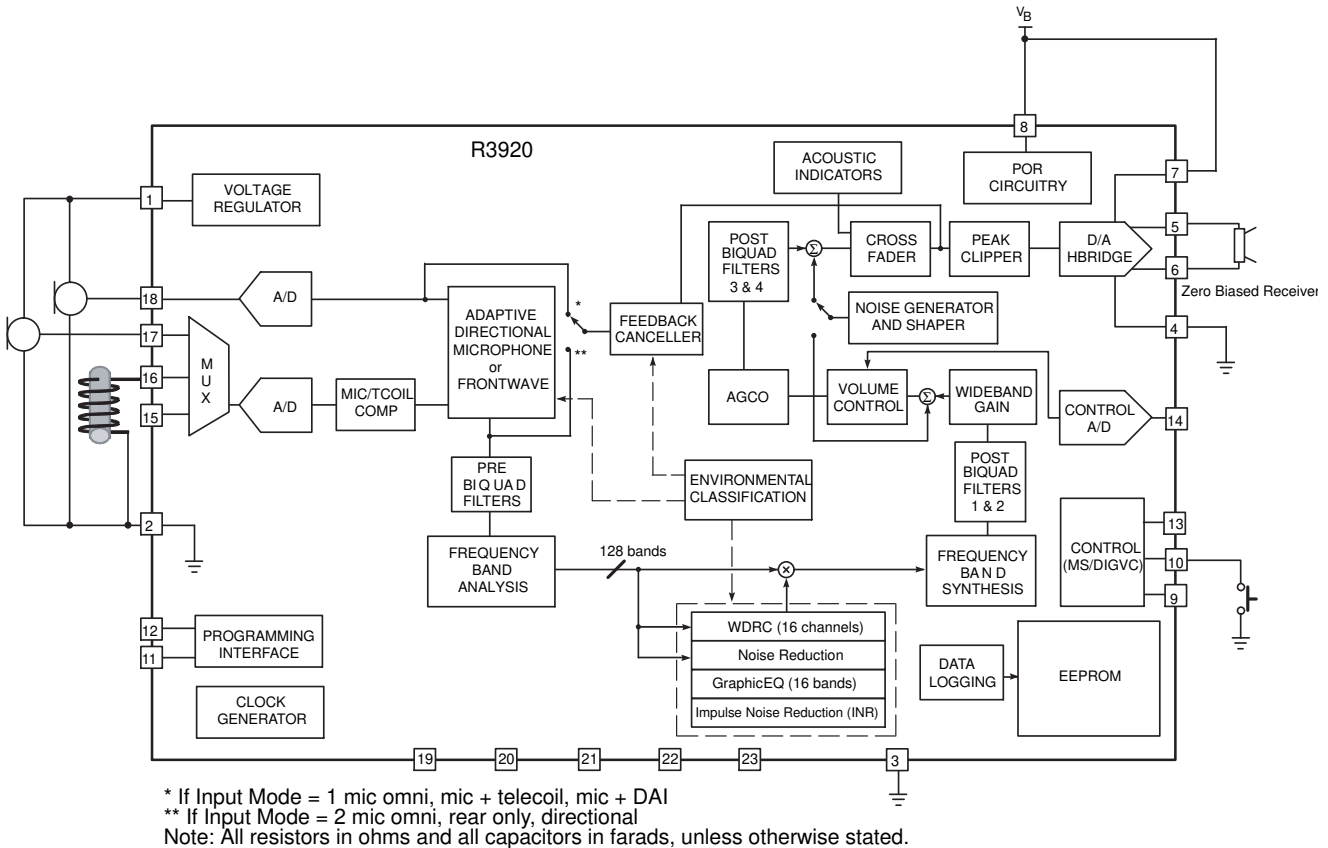

Figure 4. Typical Application Circuit

RHYTHM R3920

ORDERING INFORMATION

Device	Package	Shipping†
R3920-CFAB-E1T	25 Pad Hybrid Case 127DN	250 Units / Tape & Reel

†For information on tape and reel specifications, including part orientation and tape sizes, please refer to our Tape and Reel Packaging Specifications Brochure, BRD8011/D.

Tools Ordering Information

To order a Hybrid Jig Evaluation Board for Rhythm R3920 contact your Sales Account Manager or FAE and use part number SA3400GEVB.

To order the DSP3 Programming box use part number SU6701-E1.

RHYTHM R3920

PAD LOCATIONS

Table 4. PAD POSITION AND DIMENSIONS

Pad No.	Pad Position		Pad Dimensions	
	X	Y	Xdim (mil)	Ydim (mil)
1	0	0	20	33
2	-27	0	20	33
3	-54	-5	20	23
4	-81	-5	20	23
5	-108	-5	20	23
6	-135	-5	20	23
7	-162	-5	20	23
8	-189	0	20	33
9	-189	42	20	23
10	-189	85	20	23
11	-162	85	20	23
12	-135	85	20	23
13	-108	85	20	23
14	-81	85	20	23
15	-54	85	20	23
16	-27	85	20	23
17	0	85	20	23
18	0	42	20	23
19	-27	42	20	23
20	-54	42	20	23
21	-81	42	20	23
22	-108	42	20	23
23	-135	42	20	23
24	-162	26.5	18	12
25	-162	53.5	18	12

RHYTHM R3920

Table 4. PAD POSITION AND DIMENSIONS

Pad No.	X	Y	Xdim (mm)	Ydim (mm)
1	0	0	0.508	0.838
2	-0.686	0	0.508	0.838
3	-1.372	-0.127	0.508	0.584
4	-2.057	-0.127	0.508	0.584
5	-2.743	-0.127	0.508	0.584
6	-3.429	-0.127	0.508	0.584
7	-4.115	-0.127	0.508	0.584
8	-4.801	0	0.508	0.838
9	-4.801	1.067	0.508	0.584
10	-4.801	2.159	0.508	0.584
11	-4.115	2.159	0.508	0.584
12	-3.429	2.159	0.508	0.584
13	-2.743	2.159	0.508	0.584
14	-2.057	2.159	0.508	0.584
15	-1.372	2.159	0.508	0.584
16	-0.686	2.159	0.508	0.584
17	0	2.159	0.508	0.584
18	0	1.067	0.508	0.584
19	-0.686	1.067	0.508	0.584
20	-1.372	1.067	0.508	0.584
21	-2.057	1.067	0.508	0.584
22	-2.743	1.067	0.508	0.584
23	-3.429	1.067	0.508	0.584
24	-4.115	0.673	0.457	0.305
25	-4.115	1.359	0.457	0.305

RHYTHM R3920

PACKAGE DIMENSIONS

SIP25, 5.59x3.18
CASE 127DN
ISSUE O

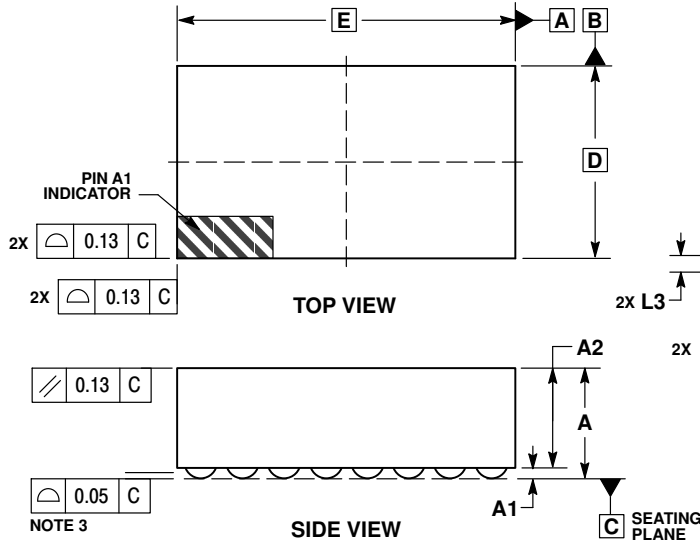

- NOTES:
1. DIMENSIONING AND TOLERANCING PER ASME Y14.5M, 1994.
 2. CONTROLLING DIMENSION: MILLIMETERS.
 3. COPLANARITY APPLIES TO THE SPHERICAL CROWNS OF THE PADS.

DIM	MILLIMETERS	
	MIN	MAX
A	---	1.83
A1	0.08	0.18
A2	---	1.65
b	0.478	0.538
b1	0.427	0.487
D	3.18 BSC	
E	5.59 BSC	
e	0.686 BSC	
e1	0.051 BSC	
e2	1.067 BSC	
e3	1.092 BSC	
L	0.554	0.614
L2	0.808	0.868
L3	0.275	0.335

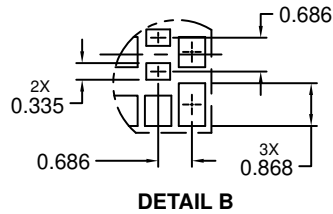
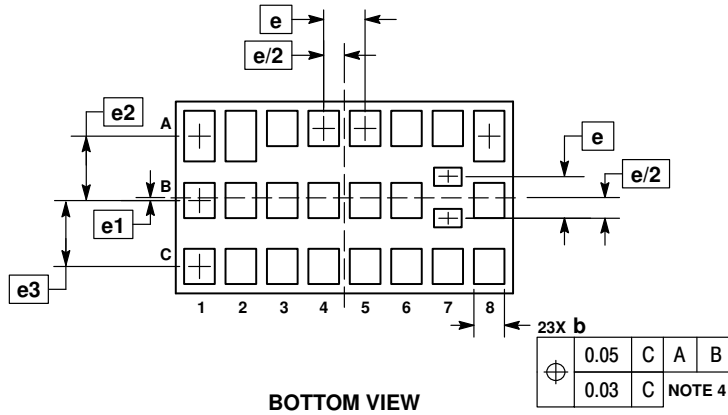
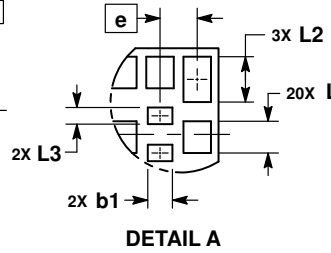

RECOMMENDED SOLDERING FOOTPRINT*

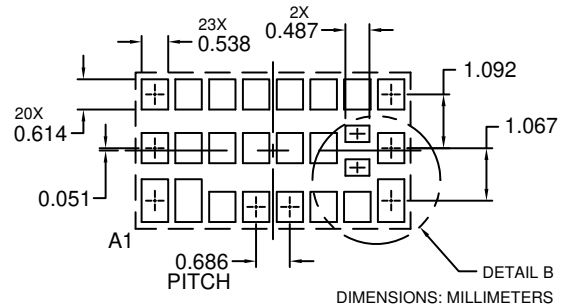

*For additional information on our Pb-Free strategy and soldering details, please download the ON Semiconductor Soldering and Mounting Techniques Reference Manual, SOLDERRM/D.

RHYTHM R3920

iSceneDetect, iLog, RHYTHM, HRX and EVOKE are trademarks of Semiconductor Components Industries, LLC.
thinSTAX, FRONTWAVE, and ARKonline are registered trademarks of Semiconductor Components Industries, LLC.

ON Semiconductor and  are trademarks of Semiconductor Components Industries, LLC dba ON Semiconductor or its subsidiaries in the United States and/or other countries. ON Semiconductor owns the rights to a number of patents, trademarks, copyrights, trade secrets, and other intellectual property. A listing of ON Semiconductor's product/patent coverage may be accessed at www.onsemi.com/site/pdf/Patent-Marking.pdf. ON Semiconductor reserves the right to make changes without further notice to any products herein. ON Semiconductor makes no warranty, representation or guarantee regarding the suitability of its products for any particular purpose, nor does ON Semiconductor assume any liability arising out of the application or use of any product or circuit, and specifically disclaims any and all liability, including without limitation special, consequential or incidental damages. Buyer is responsible for its products and applications using ON Semiconductor products, including compliance with all laws, regulations and safety requirements or standards, regardless of any support or applications information provided by ON Semiconductor. "Typical" parameters which may be provided in ON Semiconductor data sheets and/or specifications can and do vary in different applications and actual performance may vary over time. All operating parameters, including "Typicals" must be validated for each customer application by customer's technical experts. ON Semiconductor does not convey any license under its patent rights nor the rights of others. ON Semiconductor products are not designed, intended, or authorized for use as a critical component in life support systems or any FDA Class 3 medical devices or medical devices with a same or similar classification in a foreign jurisdiction or any devices intended for implantation in the human body. Should Buyer purchase or use ON Semiconductor products for any such unintended or unauthorized application, Buyer shall indemnify and hold ON Semiconductor and its officers, employees, subsidiaries, affiliates, and distributors harmless against all claims, costs, damages, and expenses, and reasonable attorney fees arising out of, directly or indirectly, any claim of personal injury or death associated with such unintended or unauthorized use, even if such claim alleges that ON Semiconductor was negligent regarding the design or manufacture of the part. ON Semiconductor is an Equal Opportunity/Affirmative Action Employer. This literature is subject to all applicable copyright laws and is not for resale in any manner.

PUBLICATION ORDERING INFORMATION

LITERATURE FULFILLMENT:

Literature Distribution Center for ON Semiconductor
19521 E. 32nd Pkwy, Aurora, Colorado 80011 USA
Phone: 303-675-2175 or 800-344-3860 Toll Free USA/Canada
Fax: 303-675-2176 or 800-344-3867 Toll Free USA/Canada
Email: orderlit@onsemi.com

N. American Technical Support: 800-282-9855 Toll Free
USA/Canada
Europe, Middle East and Africa Technical Support:
Phone: 421 33 790 2910
Japan Customer Focus Center
Phone: 81-3-5817-1050

ON Semiconductor Website: www.onsemi.com
Order Literature: <http://www.onsemi.com/orderlit>
For additional information, please contact your local
Sales Representative