



Chipsmall Limited consists of a professional team with an average of over 10 year of expertise in the distribution of electronic components. Based in Hongkong, we have already established firm and mutual-benefit business relationships with customers from,Europe,America and south Asia,supplying obsolete and hard-to-find components to meet their specific needs.

With the principle of "Quality Parts,Customers Priority,Honest Operation,and Considerate Service",our business mainly focus on the distribution of electronic components. Line cards we deal with include Microchip,ALPS,ROHM,Xilinx,Pulse,ON,Everlight and Freescale. Main products comprise IC,Modules,Potentiometer,IC Socket,Relay,Connector.Our parts cover such applications as commercial,industrial, and automotives areas.

We are looking forward to setting up business relationship with you and hope to provide you with the best service and solution. Let us make a better world for our industry!



Contact us

Tel: +86-755-8981 8866 Fax: +86-755-8427 6832

Email & Skype: info@chipsmall.com Web: www.chipsmall.com

Address: A1208, Overseas Decoration Building, #122 Zhenhua RD., Futian, Shenzhen, China



Thank you for choosing this OMNUC UP-series product.

This manual provides details on the installation, wiring, troubleshooting, and maintenance of OMNUC UP-series products along with parameter settings for the operation of the products.

- Make sure that actual users of this product will read this manual thoroughly and handle and operate the product with care.
- Retain this manual for future reference.
- This manual describes the specifications and functions of the product and relations with other products. Assume that nothing described in this manual is possible.
- Specifications and functions may change without notice to improve product performance.
- Forward and reverse rotation of AC Servomotors described in this manual are defined as looking at the end of the output shaft of the motor as follows: counterclockwise rotation (CCW) is forward and clockwise rotation (CW) is reverse.

General Instructions

1. Refer to Precautions first and carefully read and be sure to understand the information provided.
2. Familiarize yourself with this manual and understand the functions and performance of the Servomotor and Servo Driver for proper use.
3. The Servomotor and Servo Driver must be wired and the Parameter Unit must be operated by experts in electrical engineering.
4. We recommend that you add the following precautions to any instruction manuals you prepare for the system into which the product is being installed.
 - Precautions on the dangers of high-voltage equipment.
 - Precautions on touching the terminals of the product even after power has been turned off. (These terminals are live even with the power turned off.)
5. Do not perform withstand voltage or other megameter tests on the product. Doing so may damage internal components.
6. Servomotors and Servo Drivers have a finite service life. Be sure to keep replacement products on hand and to consider the operating environment and other conditions affecting the service life.
7. Do not set any parameter not described in this manual, otherwise the Servomotor or Servo Driver may malfunction. Contact your OMRON representatives if you have any inquiry.
8. The functions and specifications differ for the various models, as shown below. Be sure to check which models are being used before proceeding.
 - HA/LA/V/W AC Servo Drivers: R88D-UP□□HA, R88D-UP□□LA, R88D-UP□□V, and R88D-UP□□W
 - H/L AC Servo Drivers: R88D-UP□□H and R88D-UP□□L

NOTICE

Before using the product under the following conditions, consult your OMRON representatives, make sure that the ratings and performance characteristics of the product are good enough for the systems, machines, or equipment, and be sure to provide the systems, machines, or equipment with double safety mechanisms.

1. Conditions not described in the manual.
2. The application of the product to nuclear control systems, railroad systems, aviation systems, vehicles, combustion systems, medical equipment, amusement machines, or safety equipment.
3. The application of the product to systems, machines, or equipment that may have a serious influence on human life and property if they are used improperly.

Items to Check After Unpacking

Check the following items after removing the product from the package:

- Has the correct product been delivered (i.e., the correct model number and specifications)?
- Has the product been damaged in shipping?

The product is provided with this manual. No connectors or mounting screws are provided.

OMRON

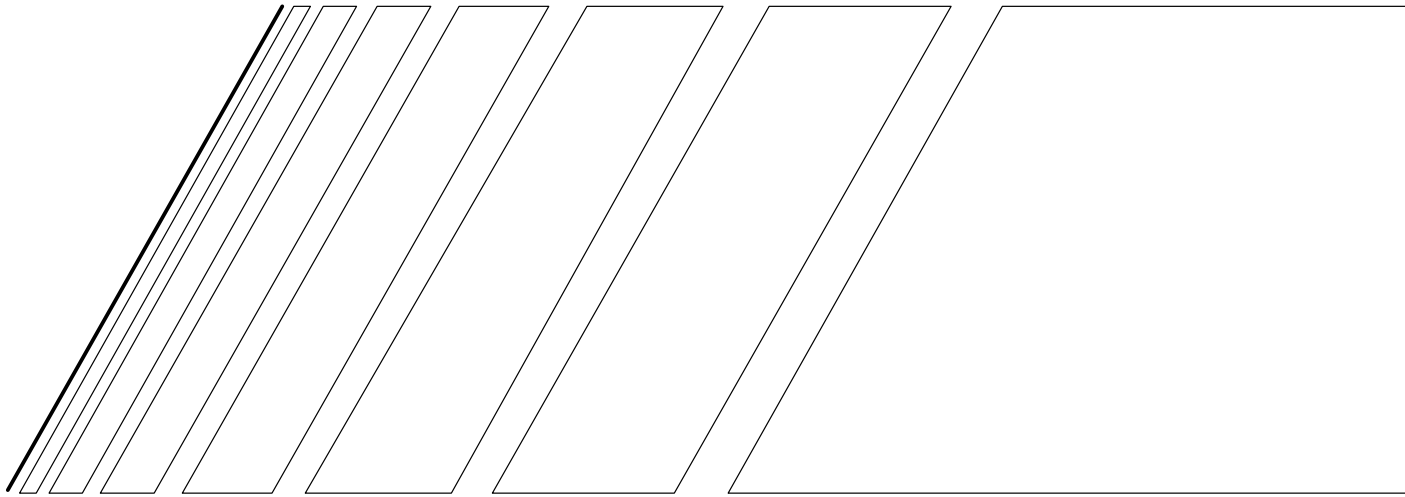

USER'S MANUAL

OMNUC U SERIES

MODELS R88M-U□
(AC Servomotors)

MODELS R88D-UP□
(AC Servo Drivers)

AC SERVOMOTORS/DRIVERS (30 to 750-W Pulse-train Inputs)

Read and Understand this Manual

Please read and understand this manual before using the product. Please consult your OMRON representative if you have any questions or comments.

Warranty and Limitations of Liability

WARRANTY

OMRON's exclusive warranty is that the products are free from defects in materials and workmanship for a period of one year (or other period if specified) from date of sale by OMRON.

OMRON MAKES NO WARRANTY OR REPRESENTATION, EXPRESS OR IMPLIED, REGARDING NON-INFRINGEMENT, MERCHANTABILITY, OR FITNESS FOR PARTICULAR PURPOSE OF THE PRODUCTS. ANY BUYER OR USER ACKNOWLEDGES THAT THE BUYER OR USER ALONE HAS DETERMINED THAT THE PRODUCTS WILL SUITABLY MEET THE REQUIREMENTS OF THEIR INTENDED USE. OMRON DISCLAIMS ALL OTHER WARRANTIES, EXPRESS OR IMPLIED.

LIMITATIONS OF LIABILITY

OMRON SHALL NOT BE RESPONSIBLE FOR SPECIAL, INDIRECT, OR CONSEQUENTIAL DAMAGES, LOSS OF PROFITS OR COMMERCIAL LOSS IN ANY WAY CONNECTED WITH THE PRODUCTS, WHETHER SUCH CLAIM IS BASED ON CONTRACT, WARRANTY, NEGLIGENCE, OR STRICT LIABILITY.

In no event shall the responsibility of OMRON for any act exceed the individual price of the product on which liability is asserted.

IN NO EVENT SHALL OMRON BE RESPONSIBLE FOR WARRANTY, REPAIR, OR OTHER CLAIMS REGARDING THE PRODUCTS UNLESS OMRON'S ANALYSIS CONFIRMS THAT THE PRODUCTS WERE PROPERLY HANDLED, STORED, INSTALLED, AND MAINTAINED AND NOT SUBJECT TO CONTAMINATION, ABUSE, MISUSE, OR INAPPROPRIATE MODIFICATION OR REPAIR.

Application Considerations

SUITABILITY FOR USE

OMRON shall not be responsible for conformity with any standards, codes, or regulations that apply to the combination of products in the customer's application or use of the products.

At the customer's request, OMRON will provide applicable third party certification documents identifying ratings and limitations of use that apply to the products. This information by itself is not sufficient for a complete determination of the suitability of the products in combination with the end product, machine, system, or other application or use.

The following are some examples of applications for which particular attention must be given. This is not intended to be an exhaustive list of all possible uses of the products, nor is it intended to imply that the uses listed may be suitable for the products:

- Outdoor use, uses involving potential chemical contamination or electrical interference, or conditions or uses not described in this manual.
- Nuclear energy control systems, combustion systems, railroad systems, aviation systems, medical equipment, amusement machines, vehicles, safety equipment, and installations subject to separate industry or government regulations.
- Systems, machines, and equipment that could present a risk to life or property.

Please know and observe all prohibitions of use applicable to the products.

NEVER USE THE PRODUCTS FOR AN APPLICATION INVOLVING SERIOUS RISK TO LIFE OR PROPERTY WITHOUT ENSURING THAT THE SYSTEM AS A WHOLE HAS BEEN DESIGNED TO ADDRESS THE RISKS, AND THAT THE OMRON PRODUCTS ARE PROPERLY RATED AND INSTALLED FOR THE INTENDED USE WITHIN THE OVERALL EQUIPMENT OR SYSTEM.

PROGRAMMABLE PRODUCTS

OMRON shall not be responsible for the user's programming of a programmable product, or any consequence thereof.

Disclaimers

CHANGE IN SPECIFICATIONS

Product specifications and accessories may be changed at any time based on improvements and other reasons.

It is our practice to change model numbers when published ratings or features are changed, or when significant construction changes are made. However, some specifications of the products may be changed without any notice. When in doubt, special model numbers may be assigned to fix or establish key specifications for your application on your request. Please consult with your OMRON representative at any time to confirm actual specifications of purchased products.

DIMENSIONS AND WEIGHTS

Dimensions and weights are nominal and are not to be used for manufacturing purposes, even when tolerances are shown.

PERFORMANCE DATA

Performance data given in this manual is provided as a guide for the user in determining suitability and does not constitute a warranty. It may represent the result of OMRON's test conditions, and the users must correlate it to actual application requirements. Actual performance is subject to the OMRON Warranty and Limitations of Liability.

ERRORS AND OMISSIONS

The information in this manual has been carefully checked and is believed to be accurate; however, no responsibility is assumed for clerical, typographical, or proofreading errors, or omissions.

Notice:

OMRON products are manufactured for use according to proper procedures by a qualified operator and only for the purposes described in this manual.

The following conventions are used to indicate and classify precautions in this manual. Always heed the information provided with them. Failure to heed precautions can result in injury to people or damage to property.

 **DANGER** Indicates an imminently hazardous situation which, if not avoided, will result in death or serious injury.

 **WARNING** Indicates a potentially hazardous situation which, if not avoided, could result in death or serious injury.

 **Caution** Indicates a potentially hazardous situation which, if not avoided, may result in minor or moderate injury, or property damage.

OMRON Product References

All OMRON products are capitalized in this manual. The word “Unit” is also capitalized when it refers to an OMRON product, regardless of whether or not it appears in the proper name of the product.

The abbreviation “Ch,” which appears in some displays and on some OMRON products, often means “word” and is abbreviated “Wd” in documentation in this sense.

The abbreviation “PC” means Programmable Controller and is not used as an abbreviation for anything else.

Visual Aids

The following headings appear in the left column of the manual to help you locate different types of information.

Note Indicates information of particular interest for efficient and convenient operation of the product.

© OMRON, 1994

All rights reserved. No part of this publication may be reproduced, stored in a retrieval system, or transmitted, in any form, or by any means, mechanical, electronic, photocopying, recording, or otherwise, without the prior written permission of OMRON.











No patent liability is assumed with respect to the use of the information contained herein. Moreover, because OMRON is constantly striving to improve its high-quality products, the information contained in this manual is subject to change without notice. Every precaution has been taken in the preparation of this manual. Nevertheless, OMRON assumes no responsibility for errors or omissions. Neither is any liability assumed for damages resulting from the use of the information contained in this publication.

General Warnings

Observe the following warnings when using the OMNUC Servomotor and Servo Driver.

This manual may include illustrations of the product with protective covers removed in order to describe the components of the product in detail. Make sure that these protective covers are on the product before use.

Consult your OMRON representative when using the product after a long period of storage.

-  **WARNING** Always connect the frame ground terminals of the Servo Driver and the Servomotor to a class-3 ground (to 100 Ω or less). Not connecting to a class-3 ground may result in electric shock.
-  **WARNING** Do not touch the inside of the Servo Driver. Doing so may result in electric shock.
-  **WARNING** Do not remove the front cover, terminal covers, cables, Parameter Units, or optional items while the power is being supplied. Doing so may result in electric shock.
-  **WARNING** Operation, maintenance, or inspection must be performed by authorized personnel. Not doing so may result in electric shock or injury.
-  **WARNING** Wiring or inspection must be performed at least 5 minutes after turning off the power supply. Doing so may result in electric shock.
-  **WARNING** Do not damage, press, or put excessive stress or heavy objects on the cables. Doing so may result in electric shock.
-  **WARNING** Do not touch the rotating parts of the Servomotor under operation. Doing so may result in injury.
-  **WARNING** Do not modify the product. Doing so may result in injury or damage to the product.
-  **Caution** Use the Servomotors and Servo Drivers in a specified combination. Doing so may result in fire or damage to the products.
-  **Caution** Do not store or install in the following places. Doing so may result in fire or damage to the Product.
 - Locations subject to direct sunlight.
 - Locations subject to temperatures or humidity outside the range specified in the specifications.
 - Locations subject to condensation as the result of severe changes in temperature.
 - Locations subject to corrosive or flammable gases.
 - Locations subject to dust (especially iron dust) or salts.
 - Locations subject to shock or vibration.
 - Locations subject to exposure to water, oil, or chemicals.

 **Caution** Do not touch the Servo Driver radiator or Servomotor while the power is being supplied or soon after the power is turned off. Doing so may result in a skin burn due to the hot surface.

Storage and Transportation Precautions

 **Caution** Do not hold by the cables or motor shaft while transporting the product. Doing so may result in injury or malfunction.

 **Caution** Do not place any load exceeding the figure indicated on the product. Doing so may result in injury or malfunction.

 **Caution** Use the motor eye-bolts only for transporting the Motor. Using them for transporting the machinery may result in injury or malfunction.

Installation and Wiring Precautions

 **Caution** Do not step on or place a heavy object on the product. Doing so may result in injury.

 **Caution** Do not cover the inlet or outlet ports and prevent any foreign objects from entering the product. Doing so may result in fire.

 **Caution** Be sure to install the product in the correct direction. Not doing so may result in malfunction.

 **Caution** Provide the specified clearances between the Servo Driver and the control panel or with other devices. Not doing so may result in fire or malfunction.





 **Caution** Do not apply any strong impact. Doing so may result in malfunction.

 **Caution** Be sure to wire correctly and securely. Not doing so may result in motor runaway, injury, or malfunction.







 **Caution** Be sure that all the mounting screws, terminal screws, and cable connector screws are tightened to the torque specified in the relevant manuals. Incorrect tightening torque may result in malfunction.

 **Caution** Use crimp terminals for wiring. Do not connect bare stranded wires directly to terminals. Connection of bare stranded wires may result in burning.

 **Caution** Always use the power supply voltage specified in the User's Manual. An incorrect voltage may result in malfunction or burning.

-  **Caution** Take appropriate measures to ensure that the specified power with the rated voltage and frequency is supplied. Be particularly careful in places where the power supply is unstable. An incorrect power supply may result in malfunction.
-  **Caution** Install external breakers and take other safety measures against short-circuiting in external wiring. Insufficient safety measures against short-circuiting may result in burning.
-  **Caution** Provide an appropriate stopping device on the machine side to secure safety. (A holding brake is not a stopping device for securing safety.) Not doing so may result in injury.
-  **Caution** Provide an external emergency stopping device that allows an instantaneous stop of operation and power interruption. Not doing so may result in injury.
-  **Caution** Take appropriate and sufficient countermeasures when installing systems in the following locations:
- Locations subject to static electricity or other forms of noise.
 - Locations subject to strong electromagnetic fields and magnetic fields.
 - Locations subject to possible exposure to radioactivity.
 - Locations close to power supplies.

Operation and Adjustment Precautions

-  **Caution** Check the newly set parameters for proper execution before actually running them. Not doing so may result in equipment damage.
-  **Caution** Do not make any extreme adjustments or setting changes. Doing so may result in unstable operation and injury.
-  **Caution** Separate the Servomotor from the machine, check for proper operation, and then connect to the machine. Not doing so may cause injury.
-  **Caution** When an alarm occurs, remove the cause, reset the alarm after confirming safety, and then resume operation. Not doing so may result in injury.
-  **Caution** Do not come close to the machine immediately after resetting momentary power interruption to avoid an unexpected restart. (Take appropriate measures to secure safety against an unexpected restart.) Doing so may result in injury.
-  **Caution** Do not use the built-in brake of the Servomotor for ordinary braking. Doing so may result in malfunction.

Maintenance and Inspection Precautions

⚠ WARNING Do not attempt to disassemble, repair, or modify any Units. Any attempt to do so may result in malfunction, fire, or electric shock.

⚠ Caution Resume operation only after transferring to the new Unit the contents of the data required for operation. Not doing so may result in an unexpected operation.

Warning Labels

Warning labels are pasted on the product as shown in the following illustration. Be sure to follow the instructions given there.

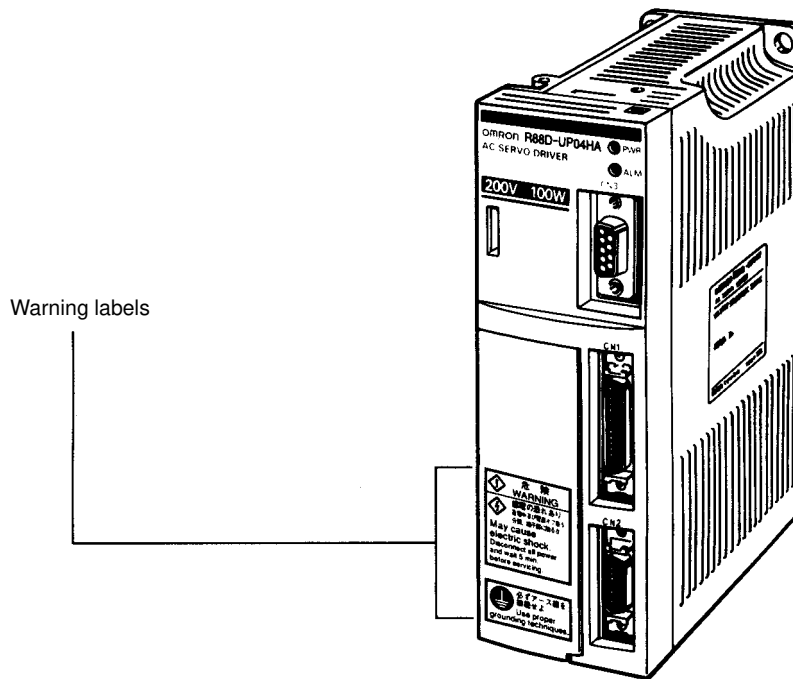

Warning Labels for Non-conforming Models



Warning label 1



Warning label 2

Warning Labels for Models Conforming to EC Directives



Warning label 1



Warning label 2

VISUAL INDEX

For users who wish to operate soon.

- The following portions of this manual provide the minimum information required for operation. Be sure you fully understand at least the information in these portions before attempting operation.

Chapter 2 System Design and Installation, and sections 3-1, 3-2, 3-3, 3-4, 3-5, and 3-6 of Chapter 3 Operation.

Instructions for jog operation using a Parameter Unit are provided in 3-6.

SYSMAC CS1/C/CV
Programmable Controller

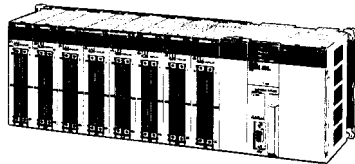

Position Control Unit

C200HW-NC113
C200HW-NC213
C200HW-NC413
C200H-NC112
C200H-NC211
C500-NC113
C500-NC211

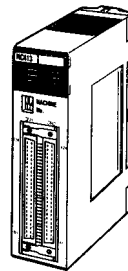

Pulse input

Controller Connecting Cable
Chapter 5: 5-3-1



OMNUC U is a series of fully software-controlled AC servo drivers built on advanced OMRON software servo technology. It provides high performance, a sensitive man-machine interface, and economy.

Setting Functions

<input type="checkbox"/> Setting User Parameters:	Section 3-5-1
<input type="checkbox"/> Internally Set Speed Control:	Section 3-5-3
<input type="checkbox"/> Electronic Gears:	Section 3-5-4
<input type="checkbox"/> Encoder Dividing:	Section 3-5-5
<input type="checkbox"/> Bias:	Section 3-5-6
<input type="checkbox"/> Torque Control:	Section 3-5-7
<input type="checkbox"/> Brake Interlock:	Section 3-5-8

Adjustments and Troubleshooting

<input type="checkbox"/> Adjustments:	Section 3-7
<input type="checkbox"/> Displays:	Section 4-1
<input type="checkbox"/> Monitor Outputs:	Section 4-2
<input type="checkbox"/> Protections and Diagnostics:	Section 4-3
<input type="checkbox"/> Troubleshooting:	Section 4-4

OMNUC U Series

OMNUC U-series AC Servo Driver

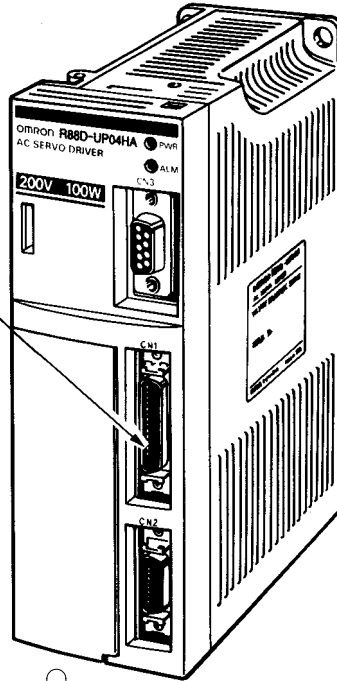

I/O Operations
Chapter 5: 5-1-3

Cable Specifications
Chapter 5: 5-3-2, 5-3-3

Encoder
signals

Power
signals

OMNUC U-series
AC Servomotor

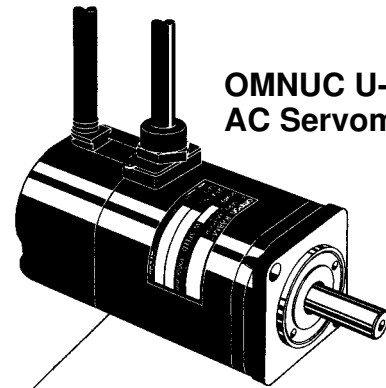

Motor Specifications
Chapter 5: 5-2

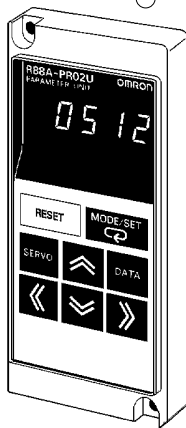

Parameter Units

Operation Method
Chapter 3: 3-3, 3-4, 3-5

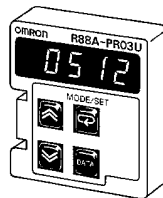

Table of Contents

Chapter 1. Introduction

- 1-1 Features
- 1-2 System Configuration
- 1-3 Servo Driver Nomenclature
- 1-4 Applicable Standards and Models
- 1-4-1 UL/cUL Standards
- 1-4-2 EC Directives

Chapter 2. System Design and Installation

- 2-1 Installation
- 2-1-1 External Dimensions (Unit: mm)
- 2-1-2 Installation Conditions
- 2-2 Wiring Products Conforming to UL/cUL
and Wiring Products Not Conforming to Any Standards
- 2-2-1 Connecting OMRON Servo Controllers
- 2-2-2 Connector-Terminal Conversion Unit
- 2-2-3 Wiring Servo Drivers
- 2-2-4 Wiring for Noise Resistance
- 2-2-5 Peripheral Device Connection Examples
- 2-3 Wiring Products Conforming to EC Directives
- 2-3-1 Connecting Servo Controllers
- 2-3-2 Wiring Servo Drivers
- 2-3-3 Wiring Products Conforming to EMC Directives
- 2-3-4 Peripheral Device Connection Examples

Chapter 3. Operation

- 3-1 Operational Procedure
- 3-2 Turning On Power and Checking Displays
- 3-2-1 Items to Check Before Turning On Power
- 3-2-2 Turning On Power and Confirming the Display
- 3-3 Using Parameter Units
- 3-3-1 Parameter Unit Keys and Functions
- 3-3-2 Modes and Changing Modes
- 3-3-3 Mode Changes and Display Contents
- 3-4 Initial Settings: Setup Parameters
- 3-4-1 Setting and Checking Setup Parameters (Cn-01, 02)
- 3-4-2 Setup Parameter Contents
- 3-4-3 Important Setup Parameters (Cn-01 and Cn-02)
- 3-5 Setting Functions: User Parameters
- 3-5-1 Setting and Checking User Parameters (Cn-04 to 29)
- 3-5-2 User Parameter Chart
- 3-5-3 Internal Speed Control Settings
- 3-5-4 Electronic Gear Function: Position Control
- 3-5-5 Encoder Dividing Function
- 3-5-6 Bias Function: Position Control
- 3-5-7 Torque Limit Function
- 3-5-8 Brake Interlock (For Motors with Brakes)
- 3-6 Trial Operation
- 3-6-1 Preparations for Trial Operation
- 3-6-2 Jog Operations

Table of Contents

3-7	Making Adjustments	
3-7-1	Auto-tuning	
3-7-2	Manually Adjusting Gain	
3-8	Regenerative Energy Absorption	
3-8-1	Calculating Regenerative Energy	
3-8-2	Servo Driver Absorbable Regenerative Energy	
3-8-3	Absorption of Regenerative Energy with the External Regeneration Resistor (Models Conforming to UL/cUL Standards and Models Not Conforming to Any Standards)	
3-8-4	Processing Regenerative Energy with Multiple Axes (Models Conforming to EC Directives)	

Chapter 4. Application

4-1	Using Displays	
4-1-1	Display Functions	
4-1-2	Status Display Mode	
4-1-3	Monitor Mode (Un-)	
4-1-4	Checking Servomotor Parameters (Cn-00 Set to 04)	
4-2	Using the Monitor Output	
4-3	Protective and Diagnostic Functions	
4-3-1	Alarm Displays and Alarm Code Outputs	
4-3-2	Alarm Output	
4-3-3	Overload Characteristics (Electron Thermal Characteristics)	
4-3-4	Alarm History Display Mode	
4-4	Troubleshooting	
4-5	Periodic Maintenance	

Chapter 5. Specifications

5-1	Servo Driver Specifications	
5-1-1	General Specifications	
5-1-2	Performance Specifications	
5-1-3	I/O Specifications	
5-1-4	Explanation of User Parameters	
5-2	Servomotor Specifications	
5-2-1	General Specifications	
5-2-2	Performance Specifications	
5-2-3	Torque and Rotational Speed Characteristics	
5-2-4	Allowable Loads on Servomotor Shafts	
5-2-5	Encoder Specifications	
5-3	Cable Specifications	
5-3-1	Controller Connecting Cables	
5-3-2	Encoder Cables	
5-3-3	Power Cable	
5-4	Parameter Unit Specifications	
5-5	Regeneration Unit Specifications	
5-6	Front-surface Mounting Bracket Specifications	

Chapter 6. Supplementary Materials

6-1	Connection Examples	
6-2	Servo Connector Terminal Connection Unit	
6-3	OMNUC U-series Standard Models	
6-4	Parameter Setting Forms	

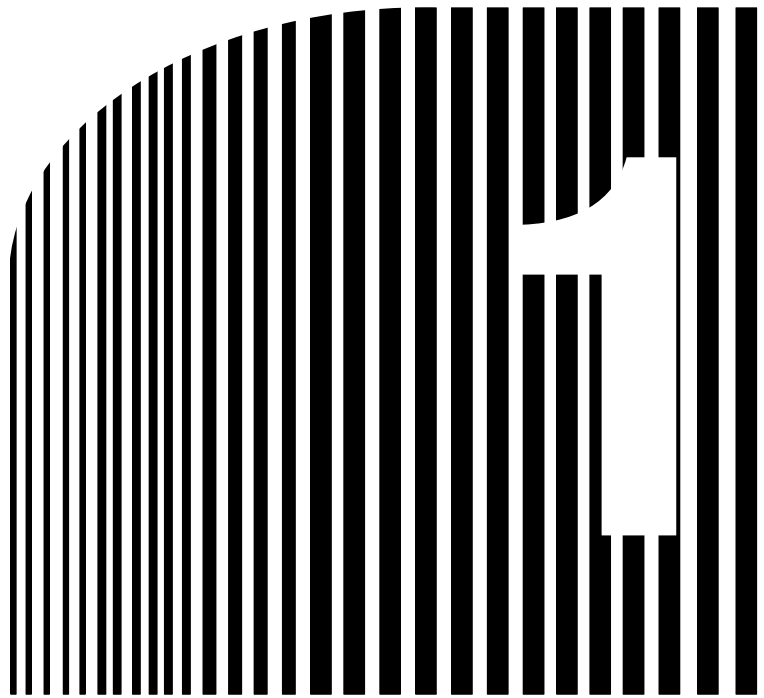

Chapter 1

• Introduction •

- 1-1 Features
- 1-2 System Configuration
- 1-3 Servo Driver Nomenclature
- 1-4 Applicable Standards and Models

1-1 Features

OMNUC AC Servo Drivers control the power supplied to AC Servomotors with pulse-train input signals and perform precision position control. There are 7 types of AC Servomotors: 30-W, 50-W, 100-W, 200-W, 300-W, 400-W, and 750-W.

■ Motor Output Capacity

AC Servomotors with the following output capacities are available.

- For 200/230-VAC (170 to 253 V) single-phase, 50/60-Hz Input
30 W, 50 W, 100 W, 200 W, 400 W, and 750 W
- For 100/115-VAC (85 to 127 V) single-phase, 50/60-Hz Input
30 W, 50 W, 100 W, 200 W, and 300 W

The Servomotors also come with and without brakes, and with and without keys on the straight shaft. Servomotors that conform to EC Directives, however, are available only with keys on the shaft.

■ Models Conforming to UL/cUL Standards Available (UL/cUL Markings)

AC Servomotors and Servo Drivers that conform to UL/cUL Standards are now available. Their performance, functionality, and appearance are the same as the conventional U-series (HA/LA) models. They are useful for obtaining approvals required for specific applications.

Models conforming to UL/cUL Standards have the same product names as conventional U-series (HA/LA) models. As shown in the following table, they are distinguished by the manufacturing date.

Model	Manufacturing date	Type	Remarks
Models not conforming to any standards	Before April 1998	H/L, HA/LA	Production of H/L models discontinued.
Models conforming to UL/cUL Standards	After May 1998	HA/LA	UL/cUL markings are attached to products.

■ EC Directives (CE Markings)

AC Servomotors and Servo Drivers that conform to EC low-voltage and EMC directives are now available. These provide the same performance and functions as the rest of the U Series (HA/LA), and will aid in obtaining specifications.

■ Control Functions

Any one of the following 4 control modes can be selected in the parameter settings.

- Position Control (Factory Setting)

Controls the position and speed of the Servomotor very precisely with pulse-train input signals. Any one of the following 3 pulse trains can be selected: forward/reverse pulses, feed pulses/directional signals, or 90° differential phase (A/B phases) signals.

- Position Control with Pulse Stop Input Enabled (HA/LA/V/W Models)

Turning ON the Pulse Stop Input (IPG) prevents the control signals from being read by the Unit during position control.

- Internal Speed Control Settings

The speed of the motor is controlled with the three speeds (No. 1, No. 2, and No. 3 internal speed settings) set in the parameters. This mode is effective for simple position control or speed-switching operation.

- Internal Speed Control Setting + Position Control (HA/LA/V/W Models)

Speed control can be performed with the internal speed settings and position control can be performed with pulse-train inputs.

■ Auto-tuning

The gain can be adjusted automatically when the responsiveness has been selected to match the rigidity of the mechanical system. The auto-tuning feature automatically finds the optimum adjustment to match the load, with no need for difficult operations.

■ Monitor

Displays the driver's operating status on the Parameter Unit.

The following items can be monitored: speed feedback, speed commands, torque commands, number of pulses from the U-phase edge, electrical angle, internal status (bit display), command pulse's speed, position deviation, and the input pulse counter.

■ Jog Operation

Forward/Reverse motor operation can be controlled from the Parameter Unit. Rotational speed can be set in the parameters.

■ Electronic Gear Function (Position Control)

The number of pulses used to rotate the motor is calculated by multiplying the number of command pulses by the electronic gear ratio. This function is useful in the following kinds of cases.

- When you want to finely adjust the position and speed of two lines that need to be synchronized
- When you want to increase the control pulse frequency of a controller with a low pulse frequency
- When you want to set the movement/pulse to a certain amount, such as 0.01 mm/pulse

The electronic gear ratio is set with parameters G1 and G2 (G1=numerator and G2=denominator). The setting range for parameters G1 and G2 is 1 to 65,535. The setting range for the gear ratio is 0.01 to 100, i.e., $0.01 \leq G1/G2 \leq 100$.

■ Encoder Resolution Function

This function allows the encoder signal output from the driver to be set anywhere from 16 to 2,048 pulses/revolution.

■ Software Start Function (Internal Speed Control Settings)

This function causes the motor to be started/stopped in the preset acceleration/deceleration times, allowing a simple position control system to be constructed without a Positioner or Host Controller.

The acceleration and deceleration times are set separately, and the setting range is 0 to 10 s for each.

■ Pulse Smoothing Function (Position Control)

Even high-frequency commands can be executed smoothly by including acceleration/deceleration in the command pulses. The same setting is used for both the acceleration and deceleration times, and the setting range is 0 to 64 ms.

■ Reverse Mode

Forward/Reverse commands can be switched in the parameters, without changing the wiring to the motor or encoder.

■ Brake Interlock Output

Outputs a timing signal interlocked with the motor's ON/OFF status and rotational speed. The holding brake of a motor with a brake can be operated reliably.

■ Overtravel Sequence

An overtravel sequence compatible with the system can be selected. There are three deceleration methods available: dynamic brake deceleration, free-run deceleration, and emergency-stop torque deceleration (parameter setting).

■ Feed-forward and Bias Functions (Position Control)

These functions reduce the position control time.

- Feed-forward Function

Reduces the position control time by reducing the number of pulses accumulated in the deviation counter.

- Bias Function

Reduces the position control time by adding the bias revolutions to the speed control when the deviation counter value exceeds the position completion range.

■ Computer Monitor Software (HA/LA/V/W Models)

The special Servo Driver Communications Software allows parameter setting, speed and current monitoring, I/O monitoring, auto-tuning, and jog operations to be performed from a personal computer. It is also possible to perform multiple-axis communications that set the parameters and monitor the operation of several drivers. Refer to the *Computer Monitor Software Instruction Manual (I513)* for OMNUC U-series Servo Drivers for more details.

1-2 System Configuration

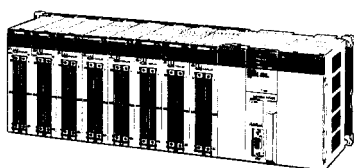

SYSMAC CS1/C/CV
Programmable Controller

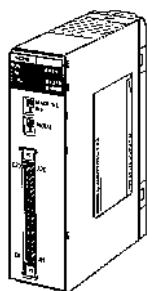

C200HW-NC113
C200HW-NC213
C200HW-NC413
C200H-NC112
C200H-NC211
C500-NC113
C500-NC211
Position Control Unit

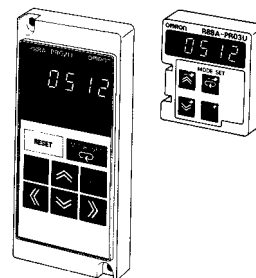

Parameter Units

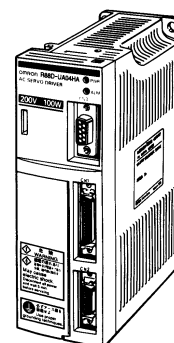

OMNUC U-series
AC Servo Driver

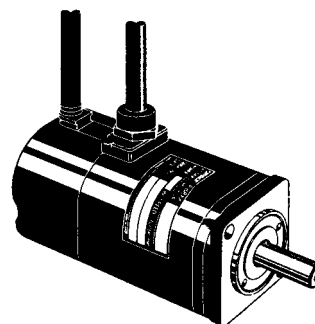

OMNUC U-series
AC Servomotor

1-3 Servo Driver Nomenclature

■ Front View

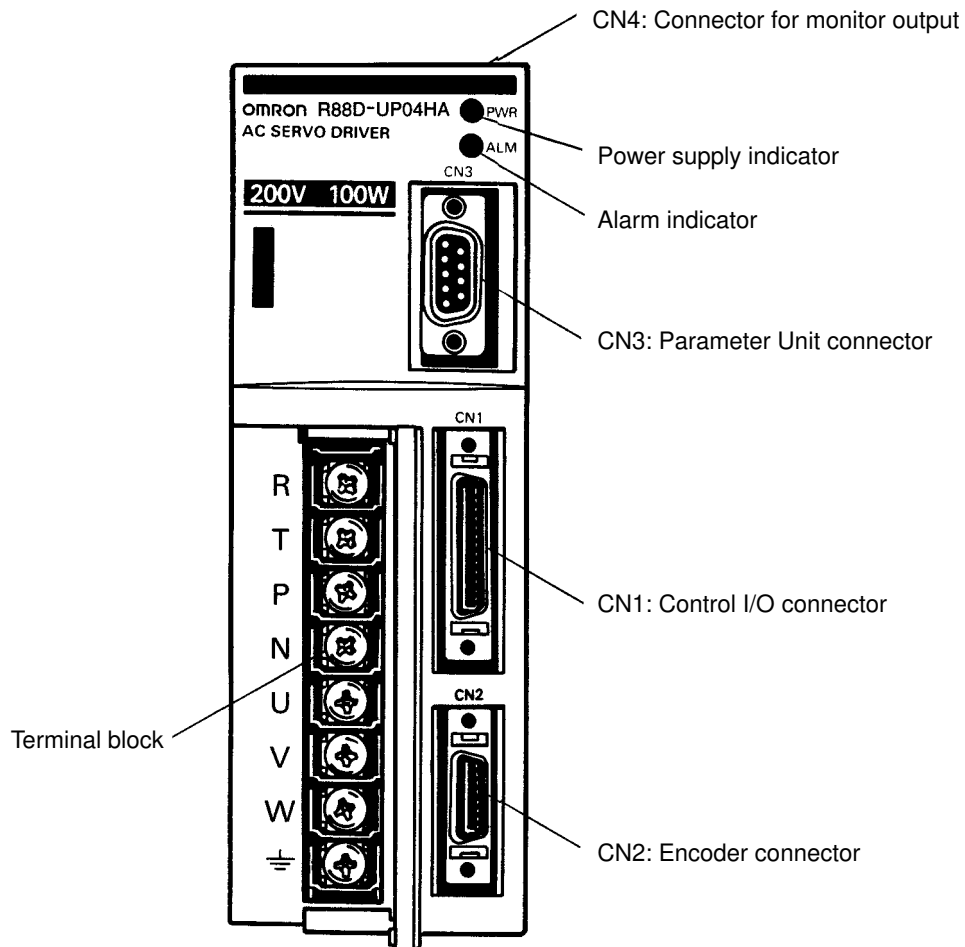

1-4 Applicable Standards and Models

1-4-1 UL/cUL Standards

■ Applicable Standards

Standard	Product	Applicable Standard	File No.	Remarks
UL	AC Servo Driver	UL508C	E179149	Power conversion equipment
	AC Servomotor	UL1004	E179189	Electric motors
cUL	AC Servo Driver	cUL C22.2 No. 14	E179149	Industrial control equipment
	AC Servomotor	cUL C22.2 No.100	E179189	Motor and generators

■ Applicable Models

Power supply	AC Servo Drivers	AC Servomotors
		With incremental encoder
200 VAC	R88D-UP□□HA (See note 1.)	R88M-U□□□30HA-□ (See note 2.) (See note 3.)
100 VAC	R88D-UP□□LA (See note 1.)	R88M-U□□□30LA-□ (See notes 2.) (See note 3.)

Note 1. Maximum output current: for example, “04” means approx. 4 A.

Note 2. Motor capacity: for example, “100” means 100 W.

Note 3. Optional specifications

None: Straight shaft without keys and without brake

B: Straight shaft without keys and with brake

S1: Straight shaft with keys and without brake

BS1: Straight shaft with keys and with brake

Note 4. UL/cUL Standards apply to models manufactured after May 1998.

1-4-2 EC Directives

■ Applicable Standards

EC Directive	Product	Directive	Remarks
Low voltage	AC Servo Driver	EN61010-1	Safety requirements for electrical equipment for measurement, control, and laboratory use.
	AC Servomotor	IEC34-1, -5, -8, -9	Rotating electrical machines.
EMC	AC Servo Driver AC Servomotor	EN55011 class A group 1	Limits and methods of measurement of radio disturbance characteristics of industrial, scientific, and medical (ISM) radio-frequency equipment.
		EN50082-2	Electromagnetic compatibility generic immunity standard, Part 2 Industrial environment.

Note Installation under the conditions specified in *2-3-3 Wiring Products Conforming to EMC Directives* is required to conform to EMC Directives.

■ Applicable Models

Power supply	AC Servo Drivers	AC Servomotors
		With incremental encoder
200 VAC	R88D-UP□□V	R88M-U□□□30VA-□ (See note.)
100 VAC	R88D-UP□□W	R88M-U□□□30WA-□ (See note.)

Note Optional specifications (shaft profile: straight shaft with keys)

S1: Straight shaft with keys and without brake

BS1: Straight shaft with keys and with brake

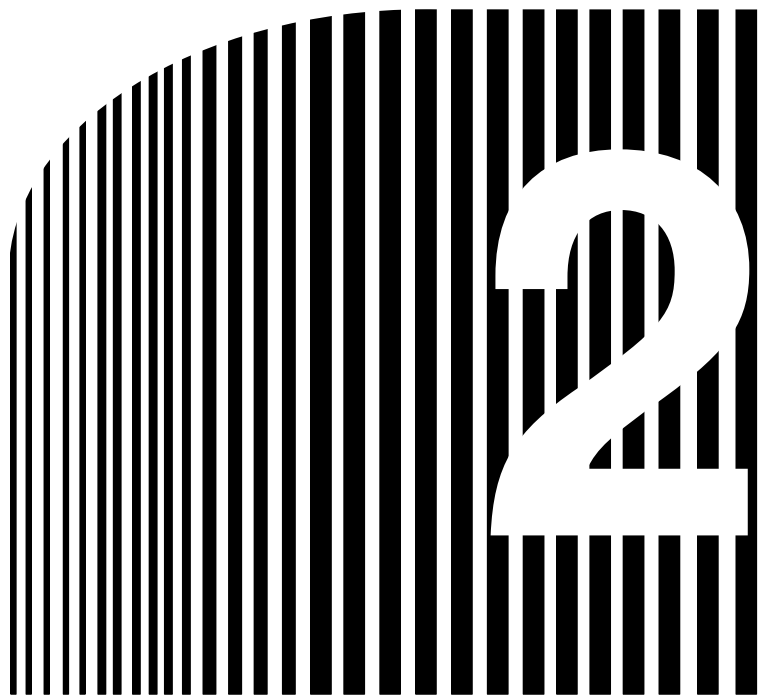















Chapter 2

• System Design and Installation •

- 2-1 Installation
- 2-2 Wiring Products Conforming to UL/cUL
and Wiring Products Not Conforming to Any
Standards
- 2-3 Wiring Products Conforming to EC Directives

Installation and Wiring Precautions

-  **Caution** Do not step on or place a heavy object on the product. Doing so may result in injury.
-  **Caution** Do not cover the inlet or outlet ports and prevent any foreign objects from entering the product. Doing so may result in fire.
-  **Caution** Be sure to install the product in the correct direction. Not doing so may result in malfunction.
-  **Caution** Provide the specified clearances between the Servo Driver and the control panel or with other devices. Not doing so may result in fire or malfunction.
-  **Caution** Do not apply any strong impact. Doing so may result in malfunction.
-  **Caution** Be sure to wire correctly and securely. Not doing so may result in motor runaway, injury, or malfunction.
-  **Caution** Be sure that all the mounting screws, terminal screws, and cable connector screws are tightened to the torque specified in the relevant manuals. Incorrect tightening torque may result in malfunction.
-  **Caution** Use crimp terminals for wiring. Do not connect bare stranded wires directly to terminals. Connection of bare stranded wires may result in burning.
-  **Caution** Always use the power supply voltage specified in the User's Manual. An incorrect voltage may result in malfunction or burning.
-  **Caution** Take appropriate measures to ensure that the specified power with the rated voltage and frequency is supplied. Be particularly careful in places where the power supply is unstable. An incorrect power supply may result in malfunction.
-  **Caution** Install external breakers and take other safety measures against short-circuiting in external wiring. Insufficient safety measures against short-circuiting may result in burning.
-  **Caution** Provide an appropriate stopping device on the machine side to secure safety. (A holding brake is not a stopping device for securing safety.) Not doing so may result in injury.
-  **Caution** Provide an external emergency stopping device that allows an instantaneous stop of operation and power interruption. Not doing so may result in injury.
-  **Caution** Take appropriate and sufficient countermeasures when installing systems in the following locations:
 - Locations subject to static electricity or other forms of noise.
 - Locations subject to strong electromagnetic fields and magnetic fields.
 - Locations subject to possible exposure to radioactivity.
 - Locations close to power supplies.