



Chipsmall Limited consists of a professional team with an average of over 10 year of expertise in the distribution of electronic components. Based in Hongkong, we have already established firm and mutual-benefit business relationships with customers from,Europe,America and south Asia,supplying obsolete and hard-to-find components to meet their specific needs.

With the principle of “Quality Parts,Customers Priority,Honest Operation,and Considerate Service”,our business mainly focus on the distribution of electronic components. Line cards we deal with include Microchip,ALPS,ROHM,Xilinx,Pulse,ON,Everlight and Freescale. Main products comprise IC,Modules,Potentiometer,IC Socket,Relay,Connector.Our parts cover such applications as commercial,industrial, and automotives areas.

We are looking forward to setting up business relationship with you and hope to provide you with the best service and solution. Let us make a better world for our industry!



Contact us

Tel: +86-755-8981 8866 Fax: +86-755-8427 6832

Email & Skype: info@chipsmall.com Web: www.chipsmall.com

Address: A1208, Overseas Decoration Building, #122 Zhenhua RD., Futian, Shenzhen, China



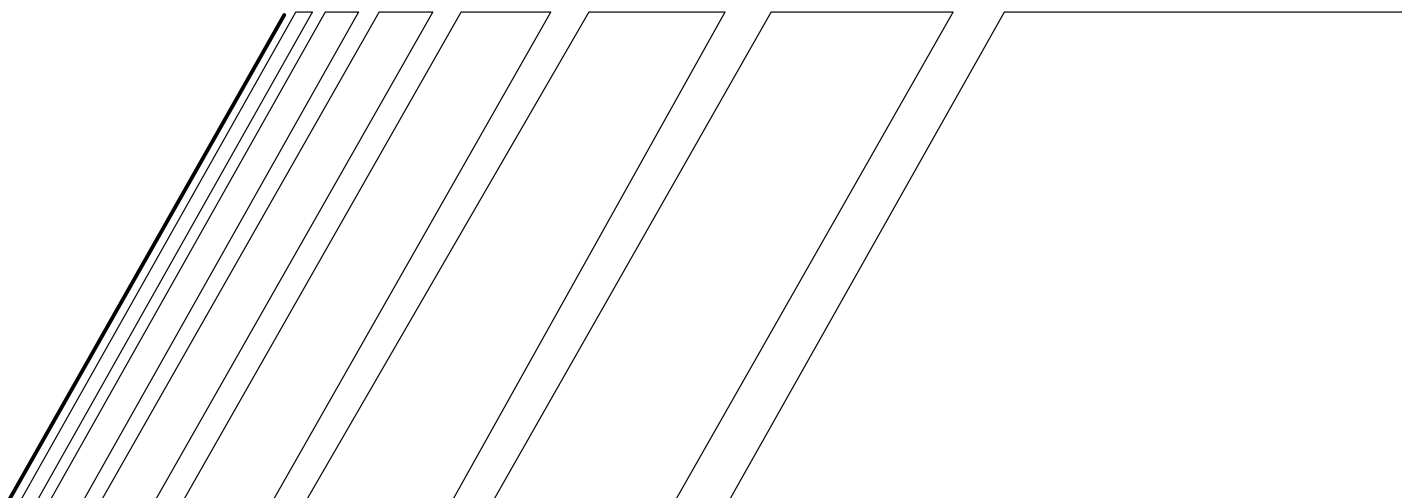

USER'S MANUAL

OMNUC FND-X SERIES

MODELS FND-X□ (DIO Type)
FND-X□-SRT (CompoBus/S Type)

POSITION DRIVERS

Thank you for choosing this OMNUC FND-X-series product.

This manual provides details on the installation, wiring, troubleshooting, and maintenance of OMNUC FND-X-series products along with parameter settings for the operation of the products.

- Make sure that actual users of this product will read this manual thoroughly and handle and operate the product with care.
- Retain this manual for future reference.
- This manual describes the specifications and functions of the product and relations with other products. Assume that nothing described in this manual is possible.
- Specifications and functions may change without notice to improve product performance.
- Forward and reverse rotation of AC Servomotors described in this manual are defined as looking at the end of the output shaft of the motor as follows: counterclockwise rotation is forward and clockwise rotation is reverse.

General Instructions

1. Refer to Precautions first and carefully read and be sure to understand the information provided.
2. Familiarize yourself with this manual and understand the functions and performance of the Servomotor and Servo Driver for proper use.
3. The Servomotor and Servo Driver must be wired and operated by experts in electrical engineering.
4. We recommend that you add the following precautions to any instruction manuals you prepare for the system into which the product is being installed.
 - Precautions on the dangers of high-voltage equipment.
 - Precautions on touching the terminals of the product even after power has been turned OFF. (These terminals are live even with the power turned OFF.)
5. Do not perform withstand voltage or other megameter tests on the product. Doing so may damage internal components.
6. Servomotors and Servo Drivers have a finite service life. Be sure to keep replacement products on hand and to consider the operating environment and other conditions affecting the service life.
7. Do not set any parameter not described in this manual, otherwise the Servomotor or Servo Driver may malfunction. Contact your OMRON representatives if you have any inquiry.

NOTICE

Before using the product under the following conditions, consult your OMRON representatives, make sure that the ratings and performance characteristics of the product are good enough for the systems, machines, or equipment, and be sure to provide the systems, machines, or equipment with double safety mechanisms.

1. Conditions not described in the manual.
2. The application of the product to nuclear control systems, railroad systems, aviation systems, vehicles, combustion systems, medical equipment, amusement machines, or safety equipment.
3. The application of the product to systems, machines, or equipment that may have a serious influence on human life and property if they are used improperly.

Items to Check After Unpacking

Check the following items after removing the product from the package:

- Has the correct product been delivered (i.e., the correct model number and specifications)?
- Has the product been damaged in shipping?

The product is provided with Safety Precautions Sheets. No connectors or mounting screws are provided.

Notice:

OMRON products are manufactured for use according to proper procedures by a qualified operator and only for the purposes described in this manual.

The following conventions are used to indicate and classify precautions in this manual. Always heed the information provided with them. Failure to heed precautions can result in injury to people or damage to property.

 **DANGER** Indicates an imminently hazardous situation which, if not avoided, will result in death or serious injury.

 **WARNING** Indicates a potentially hazardous situation which, if not avoided, could result in death or serious injury.

 **Caution** Indicates a potentially hazardous situation which, if not avoided, may result in minor or moderate injury, or property damage.

OMRON Product References

All OMRON products are capitalized in this manual. The word “Unit” is also capitalized when it refers to an OMRON product, regardless of whether or not it appears in the proper name of the product.

The abbreviation “Ch,” which appears in some displays and on some OMRON products, often means “word” and is abbreviated “Wd” in documentation in this sense.

The abbreviation “PC” means Programmable Controller and is not used as an abbreviation for anything else.

Visual Aids

The following headings appear in the left column of the manual to help you locate different types of information.

Note Indicates information of particular interest for efficient and convenient operation of the product.

© OMRON, 1998

All rights reserved. No part of this publication may be reproduced, stored in a retrieval system, or transmitted, in any form, or by any means, mechanical, electronic, photocopying, recording, or otherwise, without the prior written permission of OMRON.











No patent liability is assumed with respect to the use of the information contained herein. Moreover, because OMRON is constantly striving to improve its high-quality products, the information contained in this manual is subject to change without notice. Every precaution has been taken in the preparation of this manual. Nevertheless, OMRON assumes no responsibility for errors or omissions. Neither is any liability assumed for damages resulting from the use of the information contained in this publication.

General Precautions



Observe the following precautions when using the OMNUC Position Drivers and peripheral devices.

This manual may include illustrations of the product with protective covers removed in order to describe the components of the product in detail. Make sure that these protective covers are on the product before use.











Consult your OMRON representative when using the product after a long period of storage.

-  **WARNING** Do not touch the inside of the Servo Driver. Doing so may result in electric shock.
-  **WARNING** Always connect the frame ground terminals of the Servo Driver and the Servomotor to a class-3 ground (to 100 Ω or less). Not connecting to a class-3 ground may result in electric shock.
-  **WARNING** Do not remove the front cover, terminal covers, cables, Parameter Units, or optional items while the power is being supplied. Doing so may result in electric shock.
-  **WARNING** Operation, maintenance, or inspection must be performed by authorized personnel. Not doing so may result in operation stoppage, burning of the product, electric shock, or injury.
-  **WARNING** Wiring or inspection must be performed at least 1 minute after turning off the power supply. Doing so may result in electric shock.
-  **WARNING** Do not damage, pull on, apply stress to, place heavy objects on, or pinch the cables. Doing so may result in electric shock.
-  **WARNING** Do not touch the rotating parts of the Servomotor under operation. Doing so may result in injury.
-  **WARNING** Do not modify the product. Doing so may result in injury or damage to the product.
-  **Caution** Use the Servomotors and Servo Drivers in a specified combination. Not doing so may result in fire or damage to the products.
-  **Caution** Do not store or install the product in the following places. Doing so may result in electric shock, fire or damage to the product.
 - Locations subject to direct sunlight.
 - Locations subject to temperatures or humidity outside the range specified in the specifications.
 - Locations subject to condensation as the result of severe changes in temperature.
 - Locations subject to corrosive or flammable gases.
 - Locations subject to dust (especially iron dust) or salts.
 - Locations subject to shock or vibration.
 - Locations subject to exposure to water, oil, or chemicals.
-  **Caution** Do not touch the Servo Driver radiator, regenerative resistor, or Servomotor while the power is being supplied or soon after the power is turned off. Doing so may result in a skin burn due to the hot surface.

Storage and Transportation Precautions

-  **Caution** Do not hold by the cables or motor shaft while transporting the product. Doing so may result in injury or malfunction.
-  **Caution** Do not place any load exceeding the figure indicated on the product. Doing so may result in injury or malfunction.
-  **Caution** Use the motor eye-bolts only for transporting the Servomotor. Using them for transporting the machinery may result in injury or malfunction.

Installation and Wiring Precautions

-  **Caution** Do not step on or place a heavy object on the product. Doing so may result in injury.
-  **Caution** Do not cover the inlet or outlet ports and prevent any foreign objects from entering the product. Doing so may result in fire.
-  **Caution** Be sure to install the product in the correct direction. Not doing so may result in malfunction.
-  **Caution** Provide the specified clearances between the Servo Driver and the control panel or with other devices. Not doing so may result in fire or malfunction.
-  **Caution** Do not apply any strong impact. Doing so may result in malfunction.
-  **Caution** Be sure to wire correctly and securely. Not doing so may result in motor runaway, injury, or malfunction.
-  **Caution** Be sure to firmly tighten the screws fixing the product, the terminal block, and cables. Not doing so may result in malfunction.
-  **Caution** Use crimp terminals for wiring. Do not connect bare stranded wires directly to the terminal block. Doing so may result in fire.
-  **Caution** Use the power supply voltages specified in this manual. Not doing so may result in burning.
-  **Caution** Take appropriate measures to ensure that the specified power with the rated voltage is supplied. Be particularly careful in places where the power supply is unstable. Not doing so may result in damage to the product.
-  **Caution** Install external breakers and take other safety measures against short-circuiting in external wiring. Not doing so may result in fire.

 **Caution** Provide an appropriate stopping device on the machine side to secure safety. (A holding brake is not a stopping device for securing safety.) Not doing so may result in injury.

 **Caution** Provide an external emergency stopping device that allows an instantaneous stop of operation and power interruption. Not doing so may result in injury.

 **Caution** Take appropriate and sufficient countermeasures when installing systems in the following locations. Not doing so may result in equipment damage.

- Locations subject to static electricity or other forms of noise.
- Locations subject to strong electromagnetic fields and magnetic fields.
- Locations subject to possible exposure to radioactivity.
- Locations close to power supplies.

Operation and Adjustment Precautions

 **Caution** Confirm that no adverse effect will occur in the system before performing the test operation. Not doing so may result in equipment damage.

 **Caution** Check the newly set parameters for proper execution before actually running them. Not doing so may result in equipment damage.

 **Caution** Do not make any extreme adjustments or setting changes. Doing so may result in unstable operation and injury.

 **Caution** Separate the Servomotor from the machine, check for proper operation, and then connect to the machine. Not doing so may cause injury.

 **Caution** When an alarm occurs, remove the cause, reset the alarm after confirming safety, and then resume operation. Not doing so may result in injury.

 **Caution** Do not come close to the machine immediately after resetting momentary power interruption to avoid an unexpected restart. (Take appropriate measures to secure safety against an unexpected restart.) Doing so may result in injury.

 **Caution** Do not use the built-in brake of the Servomotor for ordinary braking. Doing so may result in malfunction.

Maintenance and Inspection Precautions

 **WARNING** Do not attempt to take the Unit apart or repair. Doing either of these may result in electrical shock or injury.

 **Caution** Resume operation only after transferring to the new Unit the contents of the data required for operation. Not doing so may result in equipment damage.

Warning Labels

Warning labels are pasted on the product as shown in the following illustration. Be sure to follow the instructions given there.

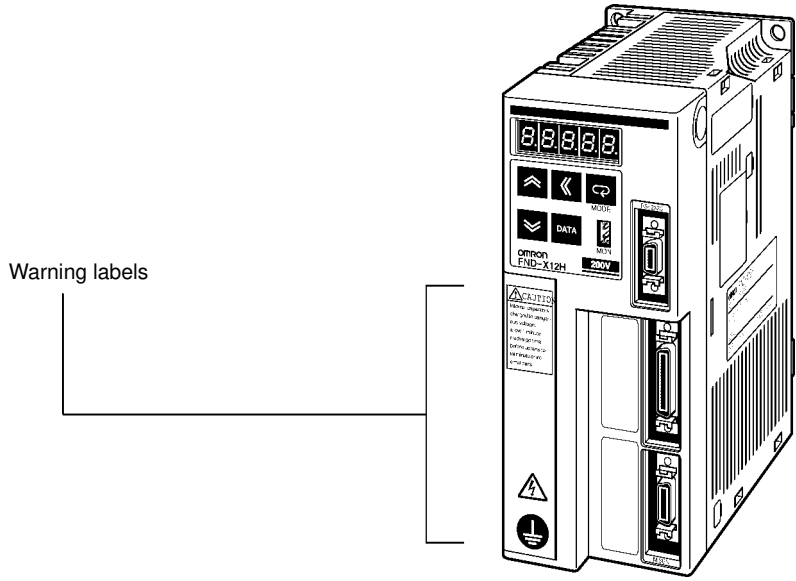

Warning Labels

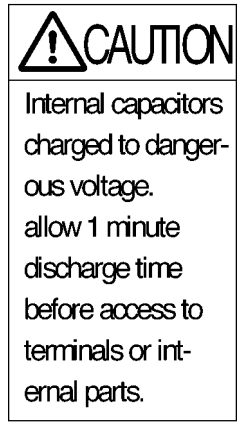

Warning label 1



May cause electric shock.

Warning label 2



Connect to a ground of 100 Ω or less.

VISUAL INDEX

For users who wish to begin operations quickly.

The OMNUC FND-X-series Position Driver allows motor test operation only by wiring the driver and motor without connecting the controller. Read *3-2 Turning ON Power and Checking Display*, properly set the motor model code, and then operate the motor according to *3-8-2 System Check Mode*.

Do not connect any load (machines) when performing test operation. Perform test operation only after confirming that no adverse effects will be caused by test operation.

SYSMAC C/CV
Programmable Controller

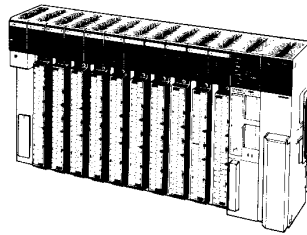

5-3-1 General Control
Cable Specifications

I/O signals

SYSMAC C200H-HX/HG/HE
or CQM1 Programmable
Controller

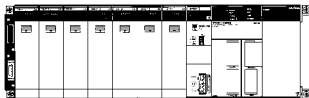

SRM1-C01/-C02
Master Controller

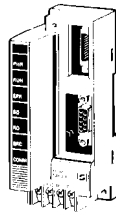

Section 6 CompoBus/S Specifications

CompoBus/S signals

Initial Operation (Starting)

- 3-1 Operation Procedure
- 3-2 Turning ON Power and Checking Displays

Function Settings (Parameter Settings)

- 3-4 Setting Functions: User Parameters (H Parameters)
- 3-5 Position Control Settings (PTP Parameters)
- 3-6 Setting Positioning Data (PTP Data, Direct Input)

Trial Operation and Adjustments

- 3-8-1 Trial Operation Procedure
- 3-8-2 System Check Mode
- 3-9-1 Auto-tuning
- 3-9-2 Manually Adjusting Gain

Troubleshooting

- 4-4 Protection and Diagnosis
- 4-5 Troubleshooting

OMNUC FND-X Series

Teaching Box

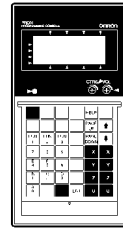

CVM1-PRO01 Teaching Box
ROM Cassette:
CVM1-MP702
(Common for MC Units and
Position Drivers)
CVM1-MP703

For details refer to Cat. No. W354-E1.

OMNUC FND-X-series Position Drivers

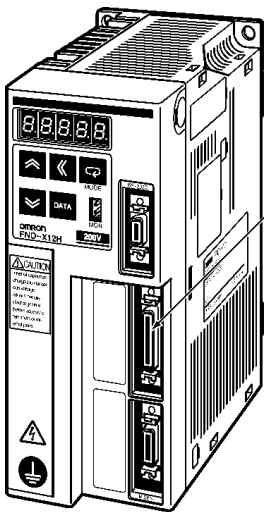

2-2-2 Control Circuitry
Terminal Wiring

DIO Type
200 V: FND-X□□H
100 V: FND-X□□L

RS-422 Teaching Box connections cable



5-1 Position Driver Specifications
2-2-3 Wiring Terminal Blocks
3-3-3 Mode Details
6-3 Connecting a CompoBus/S
System

CompoBus/S Type
200 V: FND-X□□H-SRT
100 V: FND-X□□L-SRT

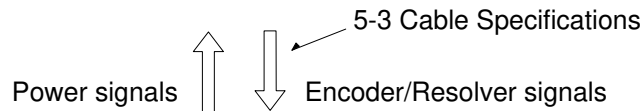

OMNUC M-series AC Servomotors

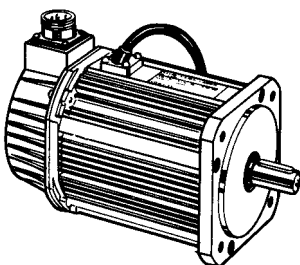

1200 r/min: 200 to 1.8 kW with Resolver
2000 r/min: 200 to 2.2 kW with Resolver
4000 r/min: 60 to 2 kW with Resolver

OMNUC U-series AC Servomotors

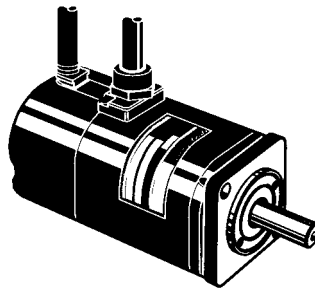

3000 r/min: 30 to 2 kW with
Incremental Encoder
3000 r/min: 30 to 2 kW with
Absolute Encoder

OMNUC U-UE-series AC Servomotors

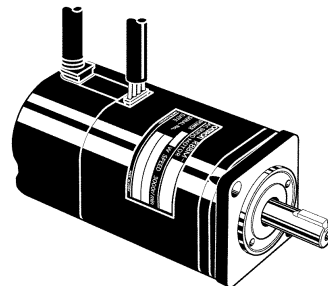

3000 r/min: 100 to 750 W with
Incremental Encoder

OMNUC H-series AC Servomotors

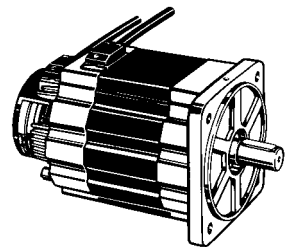

3000 r/min: 50 to 1100 W with
Incremental Encoder

Table of Contents

Chapter 1. Introduction

- 1-1 Functions
- 1-2 Nomenclature and Key Operations
- 1-3 Supported Standards and Supporting Models
- 1-3-1 Standards Supported by Position Drivers
- 1-3-2 Standards Supported by AC Servomotors

Chapter 2. Design and Installation

- 2-1 Installation
- 2-1-1 External Dimensions (Unit: mm)
- 2-1-2 Installation Conditions
- 2-2 Wiring
- 2-2-1 Overview
- 2-2-2 Control Circuitry Terminal Wiring
- 2-2-3 Wiring Terminal Blocks
- 2-2-4 Wiring for Noise Resistance
- 2-2-5 Wiring Products Conforming to EMC Directives
- 2-2-6 Peripheral Device Connection Examples
- 2-2-7 Battery Wiring and Encoder Setup for Absolute Encoder

Chapter 3. Operation

- 3-1 Operational Procedure
- 3-2 Turning ON Power and Checking Displays
- 3-2-1 Items to Check Before Turning ON the Power
- 3-2-2 Turning ON the Power and Checking the Display
- 3-3 Using the Display Area
- 3-3-1 Key Operations
- 3-3-2 Modes and Mode Changes
- 3-3-3 Mode Details
- 3-3-4 CompoBus/S Communications Display and Setting Panel
- 3-4 Setting Functions: User Parameters (H Parameters)
- 3-4-1 Setting User Parameters and H Parameters
- 3-4-2 User Parameter and H Parameter Tables
- 3-4-3 User Parameter and H Parameter Details
- 3-5 Position Control Settings (PTP Parameters)
- 3-5-1 Setting PTP Parameters (PP-01 to PP-26)
- 3-5-2 PTP Parameters (PP-01 to PP-26)
- 3-5-3 PTP Parameter Details (PP-01 to PP-26)
- 3-6 Setting Positioning Data (PTP Data, Direct Input)
- 3-6-1 Setting PTP Data (When UP-01 is 11 or 12)
- 3-6-2 Setting Direct Input (When UP-01 is 13 or 14)
- 3-6-3 PTP Data (Pd01jj to Pd64j)
- 3-6-4 PTP Data Details (Pdjjj)
- 3-7 Operational Sequence
- 3-7-1 Origin Search
- 3-7-2 Origin Teaching
- 3-7-3 Teaching
- 3-7-4 Point Positioning (UP-01: 11 or 12)
- 3-7-5 Direct Positioning (UP-01: 13 or 14)
- 3-8 Trial Operation
- 3-8-1 Trial Operation Procedure
- 3-8-2 System Check Mode

Table of Contents

3-9	Making Adjustments	
3-9-1	Auto-tuning	
3-9-2	Manually Adjusting Gain	
3-9-3	Adjustment Parameter Details	
3-10	Regenerative Energy Absorption	
3-10-1	Calculating Regenerative Energy	
3-10-2	Position Driver Absorbable Regenerative Energy	
3-10-3	Regenerative Energy Absorption by Regeneration Resistor	

Chapter 4. Application

4-1	Monitor Mode	
4-2	Check Mode	
4-2-1	I/O Signal Status	
4-3	Monitor Output	
4-4	Protection and Diagnosis	
4-4-1	Alarms	
4-4-2	Countermeasures to Alarms	
4-4-3	CompoBus/S-type Position Driver Protective and Diagnostic Functions	
4-4-4	Overload Characteristics	
4-4-5	Alarm Output	
4-5	Troubleshooting	
4-5-1	Preliminary Inspection	
4-5-2	Precautions	
4-5-3	Replacing the Position Driver and the Motor	
4-5-4	Troubleshooting	
4-6	Periodic Maintenance	

Chapter 5. Specifications

5-1	Position Driver Specifications	
5-1-1	General Specifications (Common to DIO, CompoBus/S)	
5-1-2	Performance Specifications	
5-1-3	I/O Specifications	
5-2	Servomotor Specifications	
5-2-1	U-series 30-W to 750-W Servomotors (INC/ABS)	
5-2-2	U-UE-series Servomotors	
5-2-3	U-series 1-kW to 2-kW Servomotors (INC/ABS)	
5-2-4	H-series Servomotors	
5-2-5	M-series Servomotors	
5-3	Cable Specifications	
5-3-1	General Control Cables (DIO Position Drivers Only)	
5-3-2	Connector Terminal Board Conversion Unit Cables (DIO Position Drivers Only) ..	
5-3-3	External Control Signal Connecting Cables (CompoBus/S Position Drivers Only) ..	
5-3-4	Encoder Cables	
5-3-5	Resolver Cables	
5-3-6	Power Cables	

Chapter 6. CompoBus/S Specifications

6-1	CompoBus/S Configuration Requirements	
6-2	CompoBus/S Communications Specifications	
6-3	Connecting a CompoBus/S System	

Table of Contents

Chapter 7. Appendices

7-1 Standard Models

7-2 Parameter Settings Tables

Revision History

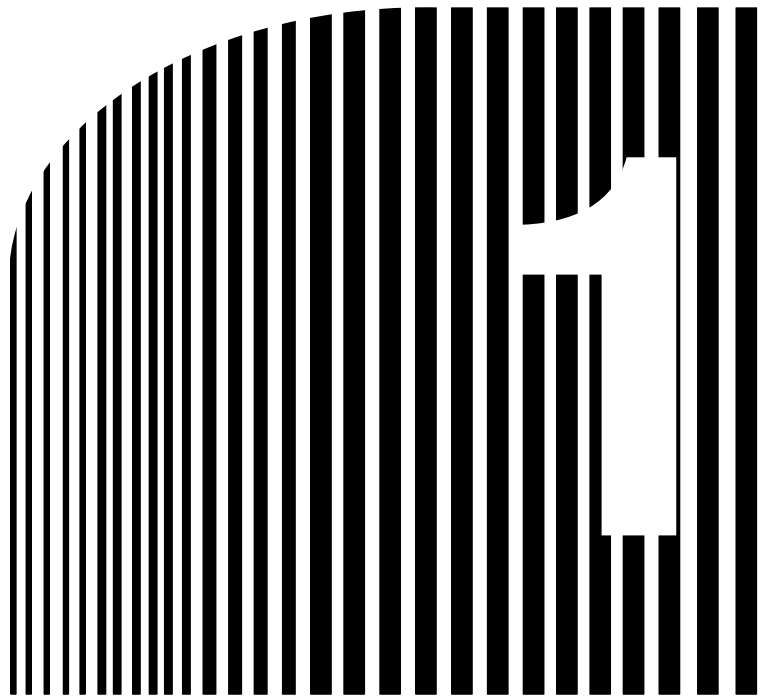

Chapter 1

• Introduction •

- 1-1 Functions
- 1-2 Nomenclature and Key Operations
- 1-3 Supported Standards and Supporting Models

1-1 Functions

OMRON's FND-X Position Drivers are servo drivers with built-in positioner functions that control AC servomotors according to positioning data.

FND-X-Series Models

There are two types of FND-X Position Drivers, according to the type of control signals used.

Control signals	Model		
DIO	FND-X	H/FND-X	L
CompoBus/S	FND-X	H-SRT/FND-X	L-SRT

Up to eight CompoBus/S Position Drivers can be connected to one Master Unit for 128 input and 128 output points. Two-wire communications are used, reducing system wiring. High-speed communications are also achieved, with a communications cycle time of 0.5 or 0.8 ms.

Note Only the high-speed communications mode is available with the FND-X.

International Standards: EC Directives and UL/cUL Standards

Position Drivers manufactured beginning April 1999 are available that conform to EC directives and UL/cUL standards, making it easier to conform to these standards in the overall system. When conforming to directives/standards, use U-series Servomotors that also conform to the require directives/standards.

Applicable Servomotor Models

The following AC Servomotors can be connected to FND-X-series Position Drivers.

- OMNUC U Series (30 to 750 W)

Servomotors Conforming to UL/cUL Standards

With incremental encoders: R88M-U HA-

With absolute encoders: R88M-U TA-

Servomotors Conforming to EC Directives

With incremental encoders: R88M-U VA-

With absolute encoder: R88M-U XA-

- OMNUC U Series (1 to 2 kW)

Servomotors Not Conforming to Standards

With incremental encoder: R88M-U H-

With absolute encoder: R88M-U T-

Servomotors Conforming to EC Directives

With incremental encoder: R88M-U V-

With absolute encoder: R88M-U X-

- OMNUC U-UE Series (100 to 750 W)

Servomotors Not Conforming to Standards

With incremental encoder: R88M-UE H-

Servomotors Conforming to EC Directives

With incremental encoder: R88M-UE V-

- OMNUC H (50 to 1,100 W) Series (with incremental encoder): R88M-H -
- OMNUC M (60 to 2,200 W) Series (with resolver): R88M-M -

Note H-series and M-series models do not conform to the EC Directives and UL/cUL standards.

- The following models are available with different output capacities, and are arranged according to input power supply.

Position Driver and AC Servomotor Combinations

Position Driver		Applicable AC Servomotor					
Input power supply	Model	Series	Model	Output capacity	Rated r/min		
Single-phase 200/240 (170 to 264) VAC at 50/60 Hz	FND-X06H-	U	R88M-U03030 A	30 W	3,000 r/min		
			R88M-U05030 A	50 W			
			R88M-U10030 A	100 W			
		U-UE	R88M-UE10030 -S1	100 W	3,000 r/min		
		H	R88M-H05030	50 W	3,000 r/min		
			R88M-H10030	100 W			
	FND-X12H-	U	R88M-U20030 A	200 W	3,000 r/min		
			R88M-U40030 A	400 W			
		U-UE	R88M-UE20030 -S1	200 W	3,000 r/min		
			R88M-UE40030 -S1	400 W			
		H	R88M-H20030	200 W	3,000 r/min		
			R88M-H30030	300 W			
		M	R88M-M06040	60 W	4,000 r/min		
			R88M-M12040	120 W			
			R88M-M20040	200 W			
			R88M-M40040	400 W			
			R88M-M20020	200 W		2,000 r/min	
			R88M-M40020	400 W			
		M	R88M-M20012	200 W	1,200 r/min		
			R88M-M40012	400 W			
	FND-X25H-		U	R88M-U75030 A		750 W	3,000 r/min
				R88M-U1K030		1000 W	
		U-UE	R88M-UE75030 -S1	750 W	3,000 r/min		
		H	R88M-H50030	500 W	3,000 r/min		
	R88M-H75030		750 W				
	R88M-H1K130		1100 W				
	M	R88M-M70040	700 W	4,000 r/min			
		R88M-M1K140	1100 W				
R88M-M70020		700 W	2,000 r/min				
R88M-M1K120		1100 W					
R88M-M70012	700 W	1,200 r/min					

Position Driver		Applicable AC Servomotor			
Input power supply	Model	Series	Model	Output capacity	Rated r/min
Three-phase 200/240 (170 to 264) VAC at 50/60 Hz	FND-X50H-	U	R88M-U1K530	1500 W	3000 r/min
			R88M-U2K030	2000 W	
		M	R88M-M2K040	2000 W	4000 r/min
			R88M-M1K820	1800 W	2000 r/min
			R88M-M2K220	2200 W	1200 r/min
			R88M-M1K112	1100 W	
			R88M-M1K412	1400 W	
R88M-M1K812	1800 W				
Single-phase 100/115 (85 to 127) VAC at 50/60 Hz	FND-X06L-	U	R88M-U03030 A	30 W	3,000 r/min
			R88M-U05030 A	50 W	
			R88M-U10030 A	100 W	
		U-UE	R88M-UE10030 -S1	100 W	3,000 r/min
		H	R88M-H05030	50 W	3,000 r/min
			R88M-H10030	100 W	
	FND-X12L-	U	R88M-U20030 A	200 W	3,000 r/min
		U-UE	R88M-UE20030 -S1	200 W	3,000 r/min
		H	R88M-H20030	200 W	3,000 r/min
		M	R88M-M06040	60 W	4,000 r/min
			R88M-M12040	120 W	
			R88M-M20040	200 W	
			R88M-M20020	200 W	2,000 r/min
		R88M-M20012	200 W	1,200 r/min	

- Note 1.** Even when a U-series or U-UE-series Servomotor is used in combination with a 100-VAC-input Position Driver, a 200-VAC Servomotor must be used. A 100-VAC Servomotor cannot be connected.
- Note 2.** Straight-axis servomotors are available either with or without a key or brake. In the above table, the Servomotors have the following features.
- U-series Straight axis without brake, without key
 - U-series UE models Straight axis without brake, with key (not available without key)
 - H-series Straight axis without brake, with key
 - M-series Straight axis without brake, with key ("A" cut for small-capacity)
- Note 3.** Motor control is enabled by setting the user parameter UP-02 of the Position Driver.
- Note 4.** U-series UE-type and H-series Servomotors can be used only with Position Driver software version 4.01 (September 1997) or later.
U-series 1-kW to 2-kW Servomotors and M-series 1.1-kW to 2.2-kW Servomotors can be used only with Position Driver software version 4.04 (April 1999) or later.

Servomotor Features and Selection Standards

Any FND-X-series Position Driver can be freely selected according to the application. When making the selection, take the following points into consideration.

Servomotor Features

U/UE Series

- Compact size, high-speed response
- High resolution (except for UE type)
- Absolute encoder system can be configured (except for UE type).

H Series

- High resolution
- High application load inertia (less than 10 times the rotary inertia)
- Usable in systems with comparatively low mechanical rigidity.

M Series

- High application load inertia (less than 10 times the rotary inertia)
- Usable in systems with comparatively low mechanical rigidity.
- High output torque in a low-rotation motor
- Up to a maximum of 50 meters between Servomotor and Servo Driver.

Motor Selection Standards (Reference)

Drive system type	Low inertia	High inertia
Ball screw direct connection	U, U-UE, H, M	U, U-UE, H, M
Turntable direct connection	U, U-UE, H, M	U, U-UE, H, M
Feeder (direct connection)	U, U-UE, H, M	U, U-UE, H, M
Harmonic drive	U, U-UE, H, M	H, M
Chain drive	U, U-UE, H, M	H, M
Belt drive	U, U-UE, H, M	H, M
Rack & pinion	U, U-UE, H, M	H, M

Note “Low inertia” means that the motor axis conversion inertia is approximately 0 to 5 times the rotary inertia for H-series and M-series Servomotors, and approximately 0 to 15 times the rotary inertia for U-series and U-series UE-type Servomotors.

“High inertia” means that the motor axis conversion inertia is approximately 5 to 10 times the rotary inertia for H-series and M-series Servomotors, and approximately 15 to 30 times the rotary inertia for U-series and U-series UE-type Servomotors.

Position Control Functions

Pulse Rate Setting Function

Pulse rate setting makes it possible to set positioning data (i.e., positions and speeds) according to the mechanical axis.

Control Mode

The following four types of control modes are available to the Position Driver: PTP control and feeder control modes with the internal point data preset in the Position Driver and these same modes with direct I/O signal input.

Internal Point Data

- A maximum of 64 points of data (Pd01 to Pd64) can be set internally in the Position Driver.
- Positions can be set within a range between –39,999,999 to 39,999,999 with the absolute or incremental value specified.

Positioning Data Instruction by Direct Input

Eight-point input and input timing signals are used to input position data and speed data within the following ranges into the Position Driver.

Position Setting Range:	–39,999,999 to 39,999,999 (with incremental or absolute setting)
Speed Setting Range:	1% to 100% (override setting with respect to reference speed)

Position Compensation Function

This function executes backlash compensation when PTP control is used, and slip compensation when feeder control is used.

Acceleration/Deceleration Function

- Either linear (trapezoidal) acceleration or deceleration time or S-shaped (primary low-pass filter) acceleration or deceleration time can be selected. In addition, different times can be set for acceleration and deceleration.
- The S-shaped acceleration/deceleration function makes it possible, for example, to start up conveyors smoothly or achieve feeder control with minimal feeder slippage.

Stop Methods

- The stop method for when the STOP signal is turned OFF can be selected with PP-24.

Free-running stop:	Motor power supply turned OFF.
Deceleration stop:	Servo-lock after the operation decelerates to a stop in preset time.
Error counter reset stop:	Servo-lock after an immediate deceleration to a stop with the error counter reset.
- The stop method of the Position Driver in the case of overrun or software limit signal detection can be selected with PP-25.

Overrun:	Servo free-running stop with the alarm AL38 turned ON or servo-lock stop.
Software limit detection:	Servo-lock stop with or without alarms AL34 and AL35 turned ON.

Teaching Functions

Position Teaching

The Position Driver has a teaching function that enables the Position Driver stop the mechanical axis with an external force by going into servo-free status or JOG operation and to take up the stop position data automatically as part of PTP data.

Mechanical Origin Teaching

An optional position can be specified as the mechanical origin by moving the position to the mechanical origin and teaching after the completion of origin search.

Motor Control Functions

Motor Type and Capacity Selection by Motor Code

A motor type and capacity can be selected by setting UP-02 to the corresponding motor code.

Auto-tuning Function

- The Position Driver has an auto-tuning function. If a machine and motor are connected to the Position Driver, this function makes it possible to check the capacity and characteristics of the machine load by turning the motor and enables the automatic gain control of the Position Driver according to the capacity and characteristics of the machine load.
- The auto-tuning function makes it possible to save system startup time.

Programming Devices

Teaching Box: CVM1-PRO01 + ROM Cassette

The Teaching Box provides for easy operation, including the following:

- Position Driver status monitoring
- Parameter editing and transfer
- Teaching
- Jogging
- Positioning to specified points
- Autotuning

Note Refer to the *CVM1-PRO01 Teaching Box Operation Manual (W354)* for more information.

OMNUC FND-X Series Monitoring Software

The OMNUC FND-X Series Monitoring Software runs on an IBM PC/AT or compatible computer and provides for easy operation, including the following:

- Position Driver status monitoring
- Parameter editing and transfer
- Speed and current waveform displays
- Autotuning

Monitor Functions

Monitor Mode

The motor speed, present value, reference value, position deviation value, machine speed, motor current, effective load factor, electronic thermal value, electrical angle, and regenerative absorption rate can be monitored on the front panel of the Position Driver in this mode.

Check Mode

The I/O signal status, alarm details, alarm history, and software version are displayed on the front panel of the Position Driver in this mode.

Protection and Self-diagnostic Functions

Hardware Protection

The Position Driver is protected from overcurrent, overvoltage, low voltage, abnormal power, clock failure, overcurrent (soft), speed amplifier saturation, and overload damage.

Mechanical System Protection

The mechanical system is protected from damage resulting from overspeed, error counter overflows, soft limit overflows, coordinate counter overflows, or overrun.

Parameter Setting-related Errors

The Position Driver detects parameter setting errors.

Detector-related Errors

Resolver wire burnout, resolver failure, encoder wire disconnection, encoder communications failure, absolute encoder backup failure, absolute encoder checksum failure, absolute encoder battery failure, absolute encoder absolute failure, absolute encoder overspeed failure, encoder data failure, and encoder initialization failure.

Position-related Errors

BCD data, indefinite PV, and PTP data non-setting errors.

Test Functions

Motor Test Function

The Position Driver has a motor test function that makes it possible to easily check whether a motor is connected to the Position Driver. When this function is enabled, the motor rotation direction can be controlled with the operation keys and the motor speed can be set in UP-29. The motor speed is set to 50 r/min before shipping.

Sequential Output Test Function

The Position Driver has a sequential output test function that makes it possible to easily check whether a host controller is connected to the Position Driver. This function makes it possible to turn any output terminal ON or OFF with the operation keys.

1-2 Nomenclature and Key Operations

DIO Position Drivers

Front View

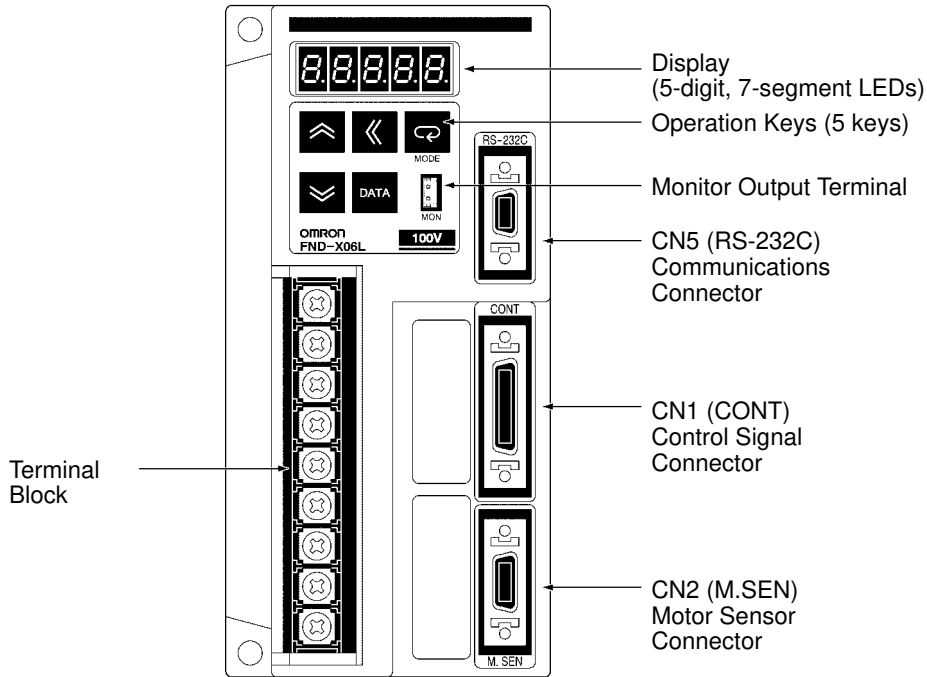

Bottom View

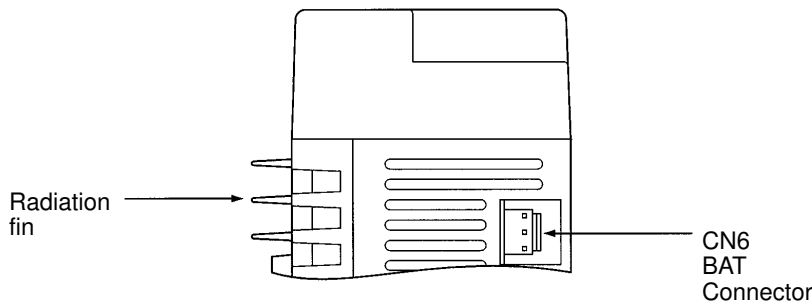

□ Key Operations

Key	Name	Main function
	Mode Key	Changes the Position Driver's mode.
	Shift Key	Shifts the operation column to the left.
	Data Key	Saves the set data.
	Increment Key	Increments the parameter address or data value.
	Decrement Key	Decrements the parameter address or data value.

CompoBus/S Position Drivers

Front View

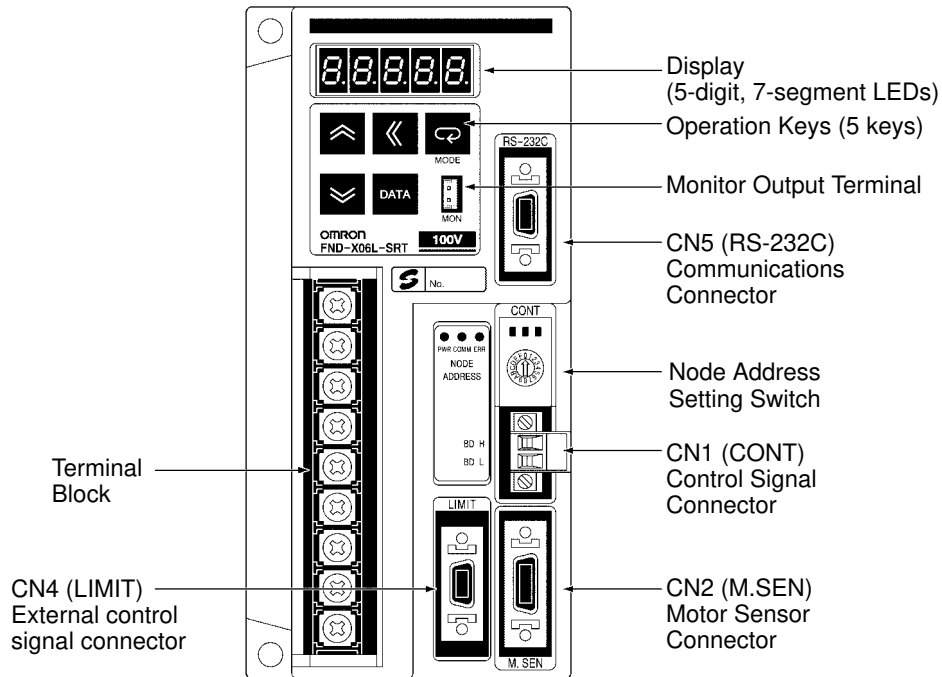

Bottom View

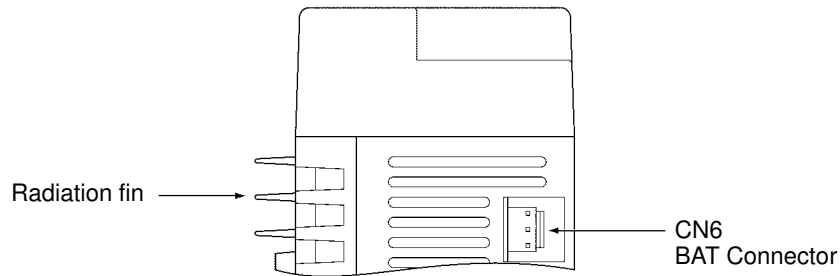

□ Key Operations

Key	Name	Main function
	Mode Key	Changes the Position Driver's mode.
	Shift Key	Shifts the operation column to the left.
	Data Key	Saves the set data.
	Increment Key	Increments the parameter address or data value.
	Decrement Key	Decrements the parameter address or data value.

1-3 Supported Standards and Supporting Models

1-3-1 Standards Supported by Position Drivers

Standard		Supported standard	File No.	Remarks
UL/cUL		UL508C	E179149	Electrical power conversion devices
EC	Low-voltage Directive	EN50178	---	Industrial product specifications
	EMC Directive	EN55011 class A group 1	---	Radio interference limits and measurement methods for radio frequency devices for industrial, scientific, and medical applications
		EN61000-4	---	Electromagnetic compatibility and immunity

Note All Position Drivers in the FND-X Series conform to UL/cUL standards and EC directives.

1-3-2 Standards Supported by AC Servomotors

Standard		Supported standard	File No.	Remarks
UL/cUL		UL1004	E179189	Electric motors
		cUL C22.2 No. 100	E179189	Motors and generators
EC	Low-voltage Directive	IEC34-1, -5, -8, -9	---	Rotating electric devices
	EMC Directive	EN55011 class A group 1	---	Radio interference limits and measurement methods for radio frequency devices for industrial, scientific, and medical applications
		EN61000-4	---	Electromagnetic compatibility and immunity

Servomotors Conforming to UL/cUL Standards

Power supply	AC Servomotors		Encoder
200 VAC	R88M-U	30HA- (30 to 750 W)	Incremental encoder
200 VAC	R88M-U	30TA- (30 to 750 W)	Absolute encoder

Note Servomotors manufactured beginning in May 1998 conform to UL/cUL standards.

Servomotors Conforming EC Directives

Power supply	AC Servomotors		Encoder
200 VAC	R88M-U	30VA- (30 to 750 W)	Incremental encoder
200 VAC	R88M-U	30XA- (30 to 750 W)	Absolute encoder
200 VAC	R88M-UE	30V- (100 to 750 W)	Incremental encoder
200 VAC	R88M-U	30V- (1 to 2 kW)	Incremental encoder
200 VAC	R88M-U	30X- (1 to 2 kW)	Absolute encoder

Note The Servomotors must be wired as described in *2-2 Wiring* to conform to the EMC Directive.

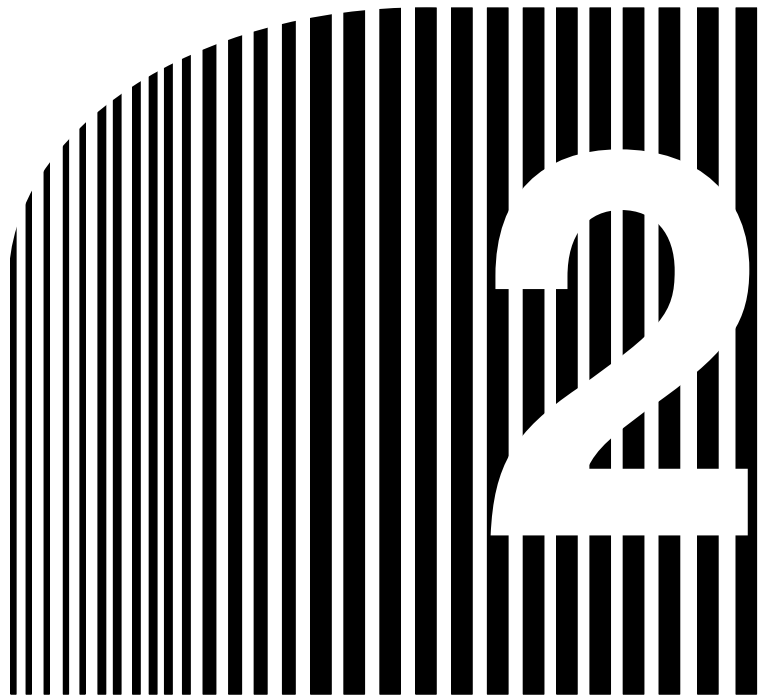

Chapter 2

- **Design and Installation**

2-1 Installation

2-2 Wiring

2-1 Installation

2-1-1 External Dimensions (Unit: mm)

DIO and CompoBus/S Position Drivers

- 200-VAC FND-X06H- /-X12H-
- 100-VAC FND-X06L- /-X12L-

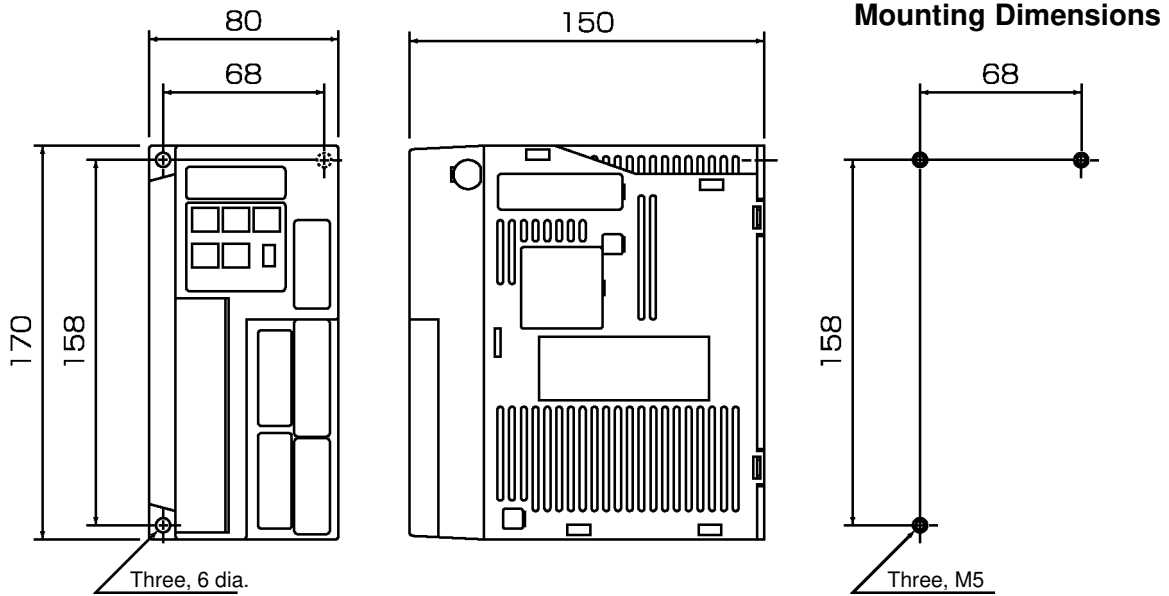

- 200-VAC FND-X25H-

