



Chipsmall Limited consists of a professional team with an average of over 10 year of expertise in the distribution of electronic components. Based in Hongkong, we have already established firm and mutual-benefit business relationships with customers from,Europe,America and south Asia,supplying obsolete and hard-to-find components to meet their specific needs.

With the principle of “Quality Parts,Customers Priority,Honest Operation,and Considerate Service”,our business mainly focus on the distribution of electronic components. Line cards we deal with include Microchip,ALPS,ROHM,Xilinx,Pulse,ON,Everlight and Freescale. Main products comprise IC,Modules,Potentiometer,IC Socket,Relay,Connector.Our parts cover such applications as commercial,industrial, and automotives areas.

We are looking forward to setting up business relationship with you and hope to provide you with the best service and solution. Let us make a better world for our industry!



## Contact us

Tel: +86-755-8981 8866 Fax: +86-755-8427 6832

Email & Skype: info@chipsmall.com Web: www.chipsmall.com

Address: A1208, Overseas Decoration Building, #122 Zhenhua RD., Futian, Shenzhen, China



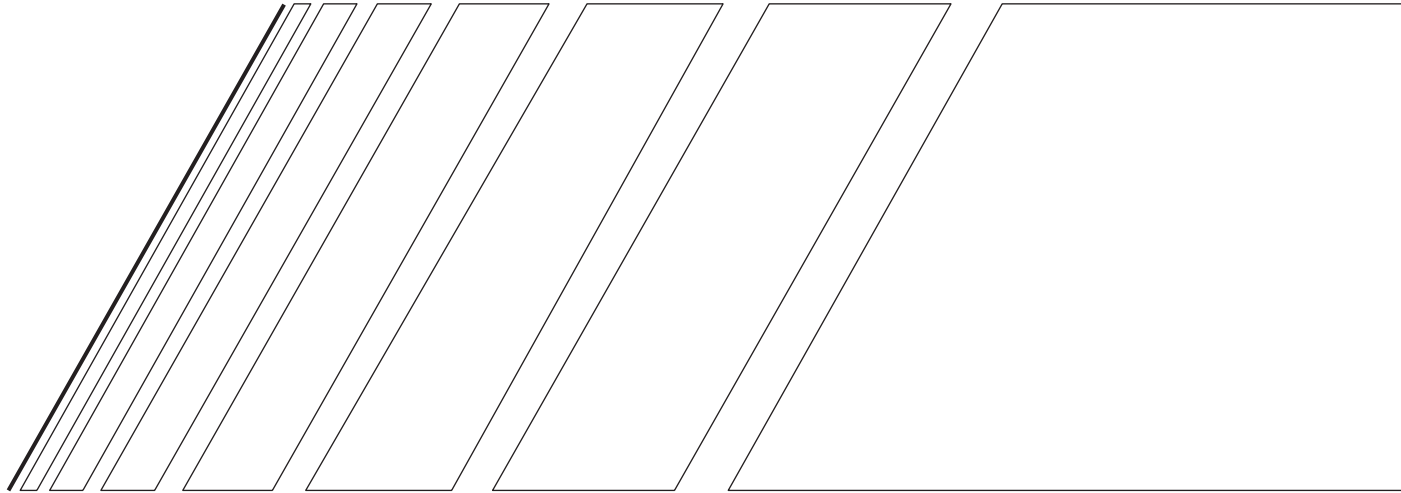

# **USER'S MANUAL**

## **OMNUC W** SERIES

MODELS R88M-W□  
(AC Servomotors)

MODELS R88D-WN□-ML2  
(AC Servo Drivers)

**AC SERVOMOTORS/SERVO DRIVERS  
WITH BUILT-IN MECHATROLINK-II COMMUNICATIONS**

---

Thank you for choosing this OMNUC W-series product. Proper use and handling of the product will ensure proper product performance, will lengthen product life, and may prevent possible accidents.

Please read this manual thoroughly and handle and operate the product with care.

---

1. To ensure safe and proper use of your OMRON Servomotors and Servo Drivers, please read this manual (Cat. No. I544-E1) to gain sufficient knowledge of the products, safety information, and precautions before actual use.
2. The products are illustrated without covers and shieldings to enable showing better detail in this manual. For actual use of the products, make sure to use the covers and shieldings as specified.
3. Copies of this manual and other related manuals must be delivered to the actual end users of the products.
4. Please keep a copy of this manual close at hand for future reference.
5. If a product has been left unused for a long time, please consult with your OMRON sales representative.

## NOTICE

1. This manual describes the functions of the product and relations with other products. You should assume that anything not described in this manual is not possible.
2. Although care has been given in documenting the product, please contact your OMRON representative if you have any suggestions on improving this manual.
3. The product contains dangerous high voltages inside. Turn OFF the power and wait for at least five minutes to allow power to discharge before handling or working with the product. Never attempt to disassemble the product.
4. We recommend that you add the following precautions to any instruction manuals you prepare for the system into which the product is being installed.
  - Precautions on the dangers of high-voltage equipment.
  - Precautions on touching the terminals of the product even after power has been turned OFF. (These terminals are live even with the power turned OFF.)
5. Specifications and functions may be changed without notice in order to improve product performance.
6. Positive and negative rotation of AC Servomotors described in this manual are defined as looking at the end of the output shaft of the motor as follows: counterclockwise rotation is positive and clockwise rotation is negative.
7. Do not perform withstand-voltage or other megameter tests on the product. Doing so may damage internal components.
8. Servomotors and Servo Drivers have a finite service life. Be sure to keep replacement products on hand and to consider the operating environment and other conditions affecting the service life.
9. The OMNUC W Series can control both incremental and absolute encoders. Differences in functions or specifications according to the encoder type are indicated in this manual. Be sure to check the model that is being used, and follow the relevant specifications.
  - Servomotors with incremental encoders: R88M-W□H-□
  - Servomotors with absolute encoders: R88M-W□T-□

## Items to Check After Unpacking

1. Check the following items after removing the product from the package:
  - Has the correct product been delivered (i.e., the correct model number and specifications)?
  - Has the product been damaged in shipping?
  - Are any screws or bolts loose?

# OMRON

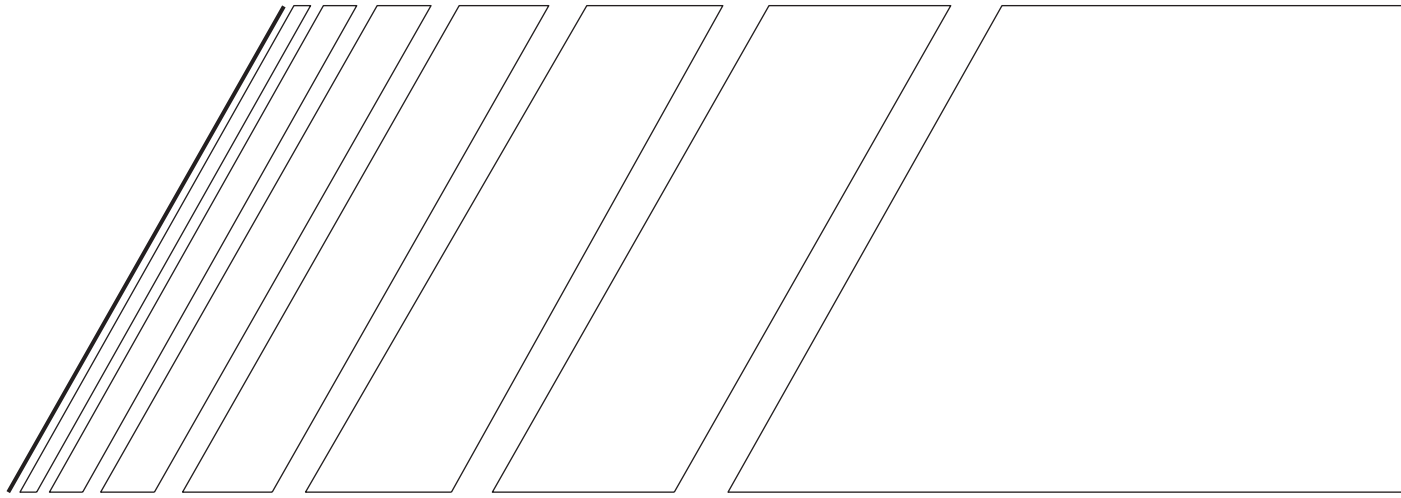

## USER'S MANUAL

# OMNUC W SERIES

MODELS R88M-W□

(AC Servomotors)

MODELS R88D-WN□-ML2

(AC Servo Drivers)

**AC SERVOMOTORS/SERVO DRIVERS  
WITH BUILT-IN MECHATROLINK-II COMMUNICATIONS**





## **Notice:**

OMRON products are manufactured for use according to proper procedures by a qualified operator and only for the purposes described in this manual.

The following conventions are used to indicate and classify precautions in this manual. Always heed the information provided with them. Failure to heed precautions can result in injury to people or damage to property.

 **DANGER** Indicates an imminently hazardous situation which, if not avoided, will result in death or serious injury. Additionally, there may be severe property damage.

 **WARNING** Indicates a potentially hazardous situation which, if not avoided, could result in death or serious injury. Additionally, there may be severe property damage.

 **Caution** Indicates a potentially hazardous situation which, if not avoided, may result in minor or moderate injury, or property damage.

## **OMRON Product References**

All OMRON products are capitalized in this manual. The word “Unit” is also capitalized when it refers to an OMRON product, regardless of whether or not it appears in the proper name of the product.

The abbreviation “Ch,” which appears in some displays and on some OMRON products, often means “word” and is abbreviated “Wd” in documentation in this sense.

The abbreviation “PC” means Programmable Controller and is not used as an abbreviation for anything else.

## **Visual Aids**

The following headings appear in the left column of the manual to help you locate different types of information.

**Note** Indicates information of particular interest for efficient and convenient operation of the product.

### **© OMRON, 2004**

All rights reserved. No part of this publication may be reproduced, stored in a retrieval system, or transmitted, in any form, or by any means, mechanical, electronic, photocopying, recording, or otherwise, without the prior written permission of OMRON.

No patent liability is assumed with respect to the use of the information contained herein. Moreover, because OMRON is constantly striving to improve its high-quality products, the information contained in this manual is subject to change without notice. Every precaution has been taken in the preparation of this manual. Nevertheless, OMRON assumes no responsibility for errors or omissions. Neither is any liability assumed for damages resulting from the use of the information contained in this publication.















## General Warnings

Observe the following warnings when using the OMNUC Servomotor and Servo Driver and all connected or peripheral devices.

This manual may include illustrations of the product with protective covers removed in order to describe the components of the product in detail. Make sure that these protective covers are on the product before use.

Consult your OMRON representative when using the product after a long period of storage.

-  **WARNING** Always connect the frame ground terminals of the Servo Driver and the Servomotor to a class-3 ground (to 100  $\Omega$  or less). Not connecting to a class-3 ground may result in electric shock.
  
-  **WARNING** Do not touch the inside of the Servo Driver. Doing so may result in electric shock.
  
-  **WARNING** Do not remove the front cover, terminal covers, cables, Parameter Units, or optional items while the power is being supplied. Doing so may result in electric shock.
  
-  **WARNING** Installation, operation, maintenance, or inspection must be performed by authorized personnel. Not doing so may result in electric shock or injury.
  
-  **WARNING** Wiring or inspection must not be performed for at least five minutes after turning OFF the power supply. Doing so may result in electric shock.
  
-  **WARNING** Do not damage, press, or put excessive stress or heavy objects on the cables. Doing so may result in electric shock.
  
-  **WARNING** Do not touch the rotating parts of the Servomotor in operation. Doing so may result in injury.
  
-  **WARNING** Do not modify the product. Doing so may result in injury or damage to the product.
  
-  **WARNING** Provide an appropriate stopping device on the machine side to secure safety. (A holding brake is not a stopping device for securing safety.) Not doing so may result in injury.
  
-  **WARNING** Provide an external emergency stopping device that allows an instantaneous stop of operation and power interruption. Not doing so may result in injury.
  
-  **WARNING** Do not come close to the machine immediately after resetting momentary power interruption to avoid an unexpected restart. (Take appropriate measures to secure safety against an unexpected restart.) Doing so may result in injury.
  
-  **Caution** Use the Servomotors and Servo Drivers in a specified combination. Using them incorrectly may result in fire or damage to the products.





 **Caution** Do not store or install the product in the following places. Doing so may result in fire, electric shock, or damage to the product.

- Locations subject to direct sunlight.
- Locations subject to temperatures or humidity outside the range specified in the specifications.
- Locations subject to condensation as the result of severe changes in temperature.
- Locations subject to corrosive or flammable gases.
- Locations subject to dust (especially iron dust) or salts.
- Locations subject to shock or vibration.
- Locations subject to exposure to water, oil, or chemicals.

 **Caution** Do not touch the Servo Driver radiator, regeneration resistor, or Servomotor while the power is being supplied or soon after the power is turned OFF. Doing so may result in a skin burn due to the hot surfaces.

## ***Storage and Transportation Precautions***

 **Caution** Do not hold the product by the cables or motor shaft while transporting it. Doing so may result in injury or malfunction.

 **Caution** Do not place any load exceeding the figure indicated on the product. Doing so may result in injury or malfunction.

 **Caution** Use the motor eye-bolts only for transporting the Motor. Using them for transporting the machinery may result in injury or malfunction.

## ***Installation and Wiring Precautions***









 **Caution** Do not step on or place a heavy object on the product. Doing so may result in injury.

 **Caution** Do not cover the inlet or outlet ports and prevent any foreign objects from entering the product. Doing so may result in fire.





 **Caution** Be sure to install the product in the correct direction. Not doing so may result in malfunction.

 **Caution** Provide the specified clearances between the Servo Driver and the control panel or with other devices. Not doing so may result in fire or malfunction.

 **Caution** Do not apply any strong impact. Doing so may result in malfunction.

-  **Caution** Be sure to wire correctly and securely. Not doing so may result in motor runaway, injury, or malfunction.
-  **Caution** Be sure that all the mounting screws, terminal screws, and cable connector screws are tightened to the torque specified in the relevant manuals. Incorrect tightening torque may result in malfunction.
-  **Caution** Use crimp terminals for wiring. Do not connect bare stranded wires directly to terminals. Connection of bare stranded wires may result in burning.
-  **Caution** Always use the power supply voltage specified in the User's Manual. An incorrect voltage may result in malfunction or burning.
-  **Caution** Take appropriate measures to ensure that the specified power with the rated voltage and frequency is supplied. Be particularly careful in places where the power supply is unstable. An incorrect power supply may result in malfunction.
-  **Caution** Install external breakers and take other safety measures against short-circuiting in external wiring. Insufficient safety measures against short-circuiting may result in burning.
-  **Caution** Take appropriate and sufficient countermeasures when installing systems in the following locations:
- Locations subject to static electricity or other forms of noise.
  - Locations subject to strong electromagnetic fields and magnetic fields.
  - Locations subject to possible exposure to radioactivity.
  - Locations close to power supplies.
-  **Caution** Do not reverse the polarity of the battery when connecting it. Reversing the polarity may damage the battery or cause it to explode.

## ***Operation and Adjustment Precautions***

-  **Caution** Confirm that no adverse effects will occur in the system before performing the test operation. Not doing so may result in equipment damage.
-  **Caution** Check the newly set parameters for proper execution before actually running them. Not doing so may result in equipment damage.
-  **Caution** Do not make any extreme adjustments or setting changes. Doing so may result in unstable operation and injury.
-  **Caution** Separate the Servomotor from the machine, check for proper operation, and then connect to the machine. Not doing so may cause injury.

 **Caution** When an alarm occurs, remove the cause, reset the alarm after confirming safety, and then resume operation. Not doing so may result in injury.

 **Caution** Do not use the built-in brake of the Servomotor for ordinary braking. Doing so may result in malfunction.

## ***Maintenance and Inspection Precautions***



 **Caution** Resume operation only after transferring to the new Unit the contents of the data required for operation. Not doing so may result in an unexpected operation.

 **Caution** Do not attempt to disassemble, repair, or modify any Units. Any attempt to do so may result in malfunction, fire, or electric shock.

## Warning Labels

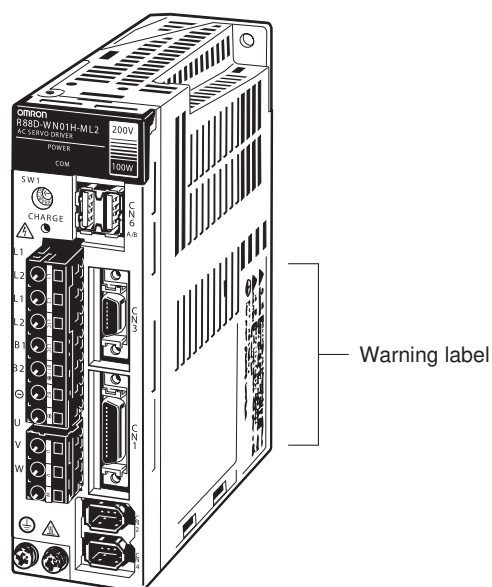
Warning labels are pasted on the product as shown in the following illustration. Be sure to follow the instructions given there.



	<b>危険</b> 通電中および電源オフ後、5分間端子部に触るな！感電の恐れあり <b>WARNING</b> Disconnect all power and wait 5 min. before servicing. May cause electric shock.
	<b>注意</b> 通電中はヒートシンクに触るな！火傷の恐れあり <b>CAUTION</b> Do not touch heatsink when power is ON. May cause burn.
	必ずアース線を接続せよ Use proper grounding techniques.

## Precautions for Safe Use

Dispose of the product and batteries according to local ordinances as they apply.  
Have qualified specialists properly dispose of used batteries as industrial waste.



廃電池請回収



## ***Read and Understand this Manual***

Please read and understand this manual before using the product. Please consult your OMRON representative if you have any questions or comments.

## ***Warranty and Limitations of Liability***

### ***WARRANTY***

OMRON's exclusive warranty is that the products are free from defects in materials and workmanship for a period of one year (or other period if specified) from date of sale by OMRON.

OMRON MAKES NO WARRANTY OR REPRESENTATION, EXPRESS OR IMPLIED, REGARDING NON-INFRINGEMENT, MERCHANTABILITY, OR FITNESS FOR PARTICULAR PURPOSE OF THE PRODUCTS. ANY BUYER OR USER ACKNOWLEDGES THAT THE BUYER OR USER ALONE HAS DETERMINED THAT THE PRODUCTS WILL SUITABLY MEET THE REQUIREMENTS OF THEIR INTENDED USE. OMRON DISCLAIMS ALL OTHER WARRANTIES, EXPRESS OR IMPLIED.

### ***LIMITATIONS OF LIABILITY***

OMRON SHALL NOT BE RESPONSIBLE FOR SPECIAL, INDIRECT, OR CONSEQUENTIAL DAMAGES, LOSS OF PROFITS OR COMMERCIAL LOSS IN ANY WAY CONNECTED WITH THE PRODUCTS, WHETHER SUCH CLAIM IS BASED ON CONTRACT, WARRANTY, NEGLIGENCE, OR STRICT LIABILITY.

In no event shall the responsibility of OMRON for any act exceed the individual price of the product on which liability is asserted.

IN NO EVENT SHALL OMRON BE RESPONSIBLE FOR WARRANTY, REPAIR, OR OTHER CLAIMS REGARDING THE PRODUCTS UNLESS OMRON'S ANALYSIS CONFIRMS THAT THE PRODUCTS WERE PROPERLY HANDLED, STORED, INSTALLED, AND MAINTAINED AND NOT SUBJECT TO CONTAMINATION, ABUSE, MISUSE, OR INAPPROPRIATE MODIFICATION OR REPAIR.

# ***Application Considerations***

## ***SUITABILITY FOR USE***

OMRON shall not be responsible for conformity with any standards, codes, or regulations that apply to the combination of products in the customer's application or use of the products.

At the customer's request, OMRON will provide applicable third party certification documents identifying ratings and limitations of use that apply to the products. This information by itself is not sufficient for a complete determination of the suitability of the products in combination with the end product, machine, system, or other application or use.

The following are some examples of applications for which particular attention must be given. This is not intended to be an exhaustive list of all possible uses of the products, nor is it intended to imply that the uses listed may be suitable for the products:

- Outdoor use, uses involving potential chemical contamination or electrical interference, or conditions or uses not described in this manual.
- Nuclear energy control systems, combustion systems, railroad systems, aviation systems, medical equipment, amusement machines, vehicles, safety equipment, and installations subject to separate industry or government regulations.
- Systems, machines, and equipment that could present a risk to life or property.

Please know and observe all prohibitions of use applicable to the products.

**NEVER USE THE PRODUCTS FOR AN APPLICATION INVOLVING SERIOUS RISK TO LIFE OR PROPERTY WITHOUT ENSURING THAT THE SYSTEM AS A WHOLE HAS BEEN DESIGNED TO ADDRESS THE RISKS, AND THAT THE OMRON PRODUCTS ARE PROPERLY RATED AND INSTALLED FOR THE INTENDED USE WITHIN THE OVERALL EQUIPMENT OR SYSTEM.**

## ***PROGRAMMABLE PRODUCTS***

OMRON shall not be responsible for the user's programming of a programmable product, or any consequence thereof.

# **Disclaimers**

## ***CHANGE IN SPECIFICATIONS***

Product specifications and accessories may be changed at any time based on improvements and other reasons.

It is our practice to change model numbers when published ratings or features are changed, or when significant construction changes are made. However, some specifications of the products may be changed without any notice. When in doubt, special model numbers may be assigned to fix or establish key specifications for your application on your request. Please consult with your OMRON representative at any time to confirm actual specifications of purchased products.

## ***DIMENSIONS AND WEIGHTS***

Dimensions and weights are nominal and are not to be used for manufacturing purposes, even when tolerances are shown.

## ***PERFORMANCE DATA***

Performance data given in this manual is provided as a guide for the user in determining suitability and does not constitute a warranty. It may represent the result of OMRON's test conditions, and the users must correlate it to actual application requirements. Actual performance is subject to the OMRON Warranty and Limitations of Liability.

## ***ERRORS AND OMISSIONS***

The information in this manual has been carefully checked and is believed to be accurate; however, no responsibility is assumed for clerical, typographical, or proofreading errors, or omissions.





# Table of Contents

---

<b>Chapter 1. Introduction. . . . .</b>	<b>1-1</b>
1-1 Features. . . . .	1-2
1-2 System Configuration . . . . .	1-4
1-3 Servo Driver Nomenclature . . . . .	1-5
1-4 Applicable Standards and Models . . . . .	1-6
1-5 System Block Diagrams . . . . .	1-7
<b>Chapter 2. Standard Models and Specifications. . . . .</b>	<b>2-1</b>
2-1 Standard Models. . . . .	2-2
2-2 Servo Driver and Servomotor Combinations . . . . .	2-16
2-3 External and Mounted Dimensions . . . . .	2-18
2-4 Servo Driver Specifications . . . . .	2-50
2-5 Servomotor Specifications . . . . .	2-71
2-6 Cable and Connector Specifications. . . . .	2-93
2-7 External Regeneration Resistor Specifications. . . . .	2-121
2-8 Absolute Encoder Backup Battery Specifications . . . . .	2-122
2-9 Reactor Specifications . . . . .	2-124
2-10 MECHATROLINK-II Repeater Specifications . . . . .	2-126
<b>Chapter 3. System Design and Installation . . . . .</b>	<b>3-1</b>
3-1 Installation Conditions . . . . .	3-3
3-2 Wiring. . . . .	3-8
3-3 Regenerative Energy Absorption . . . . .	3-32
3-4 Adjustments and Dynamic Braking When Load Inertia Is Large . . . . .	3-39
<b>Chapter 4. Operation. . . . .</b>	<b>4-1</b>
4-1 Operational Procedure . . . . .	4-3
4-2 Preparing for Operation . . . . .	4-4
4-3 User Parameters . . . . .	4-8
4-4 Operation Functions . . . . .	4-75
4-5 Trial Operation Procedure . . . . .	4-96
4-6 Making Adjustments . . . . .	4-98
4-7 Advanced Adjustment Functions . . . . .	4-103
4-8 Using Displays . . . . .	4-130
4-9 Using Monitor Output . . . . .	4-132
<b>Chapter 5. Troubleshooting . . . . .</b>	<b>5-1</b>
5-1 Measures when Trouble Occurs . . . . .	5-2
5-2 Alarms . . . . .	5-6
5-3 Troubleshooting . . . . .	5-12
5-4 Overload Characteristics (Electronic Thermal Characteristics). . . . .	5-43
5-5 Periodic Maintenance . . . . .	5-45
5-6 Replacing the Absolute Encoder Battery (ABS) . . . . .	5-47

# Table of Contents

---

<b>Chapter 6. Appendix</b> .....	<b>6-1</b>
6-1 Connection Examples .....	6-2
6-2 Parameter Setting Tables.....	6-3
6-3 Restrictions .....	6-21
<b>Index</b> .....	<b>I-1</b>
<b>Revision History</b> .....	<b>R-1</b>

---

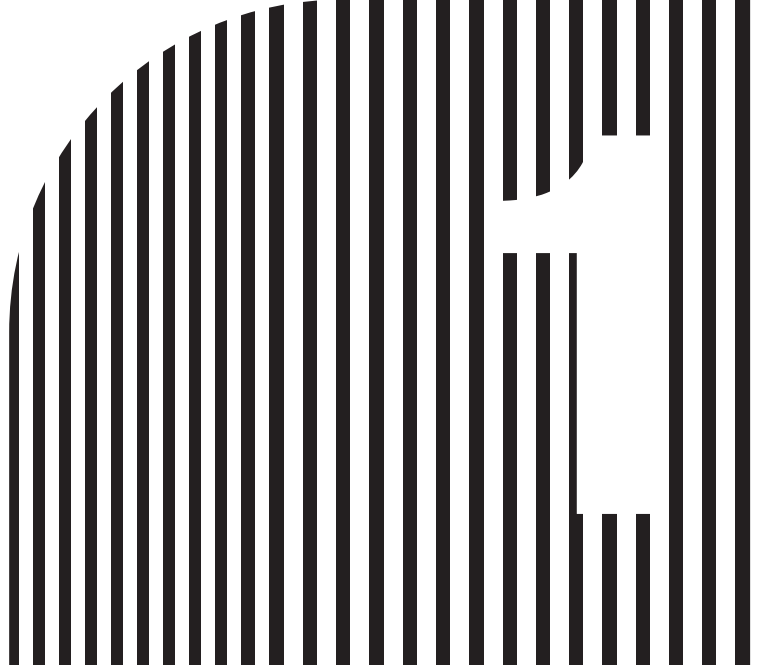

# Chapter 1

## Introduction

- 1-1 Features
- 1-2 System Configuration
- 1-3 Servo Driver Nomenclature
- 1-4 Applicable Standards and Models
- 1-5 System Block Diagrams

---

## 1-1 Features

---

---

OMNUC W-series AC Servo Drivers with built-in MECHATROLINK-II Communications are designed specifically for use with the MECHATROLINK-II high-speed motion field network.

Combining these Servo Drivers with MECHATROLINK-II-compatible Motion Control Units (CS1W-MCH71 or CJ1W-MCH71) or Position Control Units (CJ1W-NCF71) is an easy way to create a high-speed servo control system with a communications link between the Servo Drivers and the Controllers.

---

### ■ Data Transfer by MECHATROLINK-II Communications

When a Servo Driver is combined with a MECHATROLINK-II-compatible Motion Control Unit (CS1W-MCH71 or CJ1W-MCH71) or Position Control Unit (CJ1W-NCF71), all control data is transferred between the Servo Driver and the Controller by means of data communications.

Control commands are transferred by means of data communications, so Servomotor performance is not limited by control interface specifications, such as response frequencies for input pulses and encoder feedback pulses. This allows the Servomotor to perform to its fullest capacity.

Moreover, system data control is simplified by having all Servo Driver parameters and monitor data managed by the host controller.

### ■ Built-in Communications Interface

The MECHATROLINK-II communications interface has been built into the Servo Driver. In comparison with earlier W-series Servo Drivers, in which the MECHATROLINK-II Application Module is installed, only 60% of the installation surface area is required. (for 200-V/100-W Servo Drivers). This allows a great saving of space in the control panel.

### ■ W-series Servomotor Compatibility

A W-series Servomotor can be used as is, including the encoder cable and power cable, so the system can be upgraded without changing the structural design.

The W-series product line offers 3,000-r/min Servomotors (Cylinder-style: 50-W to 3-kW; Flat-style: 100-W to 1.5-kw), 1,000-r/min Servomotors (300-W to 2-kW), and 1,500-r/min Servomotors (450-W to 1.8-kW). Also, IP67 (waterproof) Servomotors can be connected in the same way.

### ■ High-speed, High-precision Motion Control Capability

A less-deviation control function and a predictive control function are provided to shorten the Servomotor's settling time and achieving high tracking capability.

The W-series Servomotors handle motion control with increased speed and precision, including synchronous control in combination with CS1W-MCH71 or CJ1W-MCH71 Motion Control Units.

**■ Regenerative Power Processing**

In addition to the built-in regenerative power processing function using regeneration resistance, external regeneration resistance can also be connected, allowing the W Series to be used for applications with high regenerative energy on vertical axes.

**■ Conformity to Standards**

The W Series conforms to EC Directives (both low-voltage and EMC) as well as to UL and cUL requirements, thereby assisting the user in meeting required standards.

**■ High-frequency Current Countermeasures**

On Servo Drivers of 1 kW and above, a current reactor connection terminal is provided to assist the user in controlling high-frequency current.

# 1-2 System Configuration

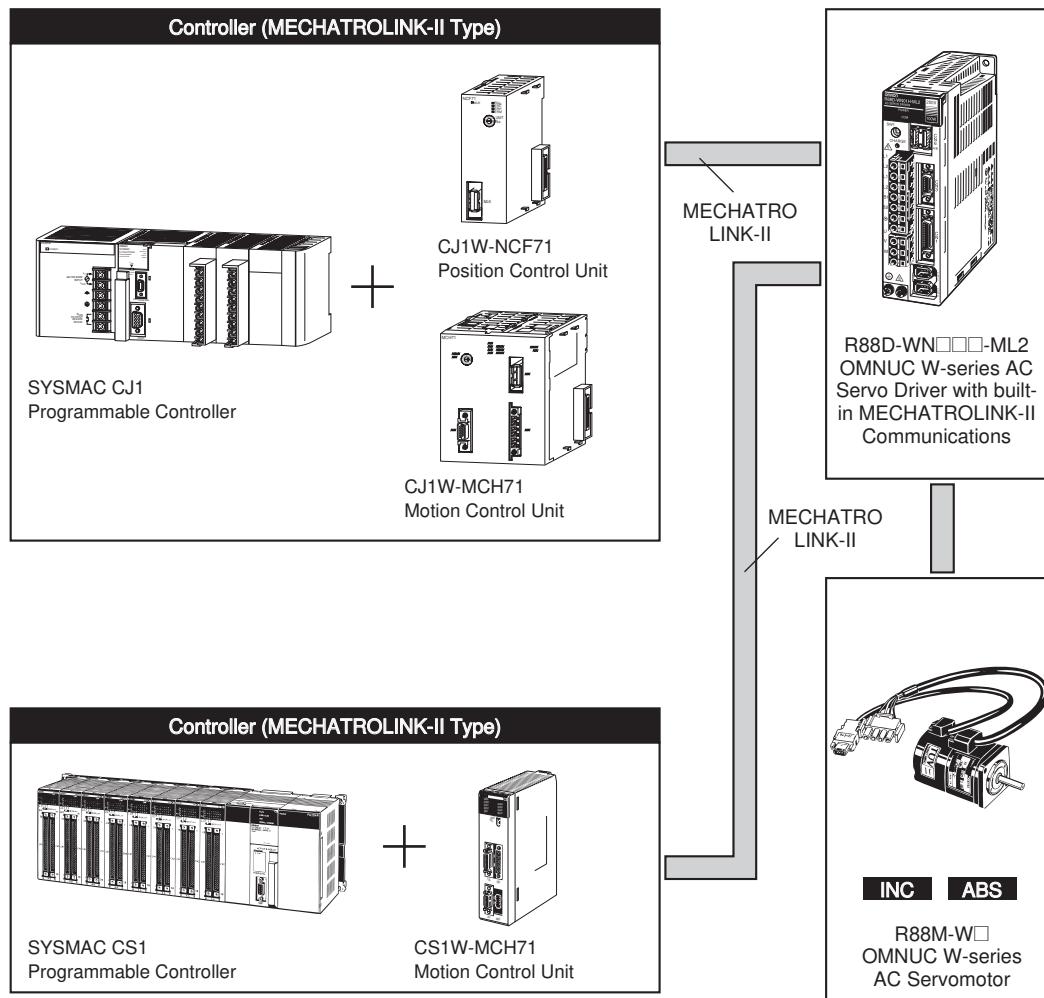

### 1-3 Servo Driver Nomenclature

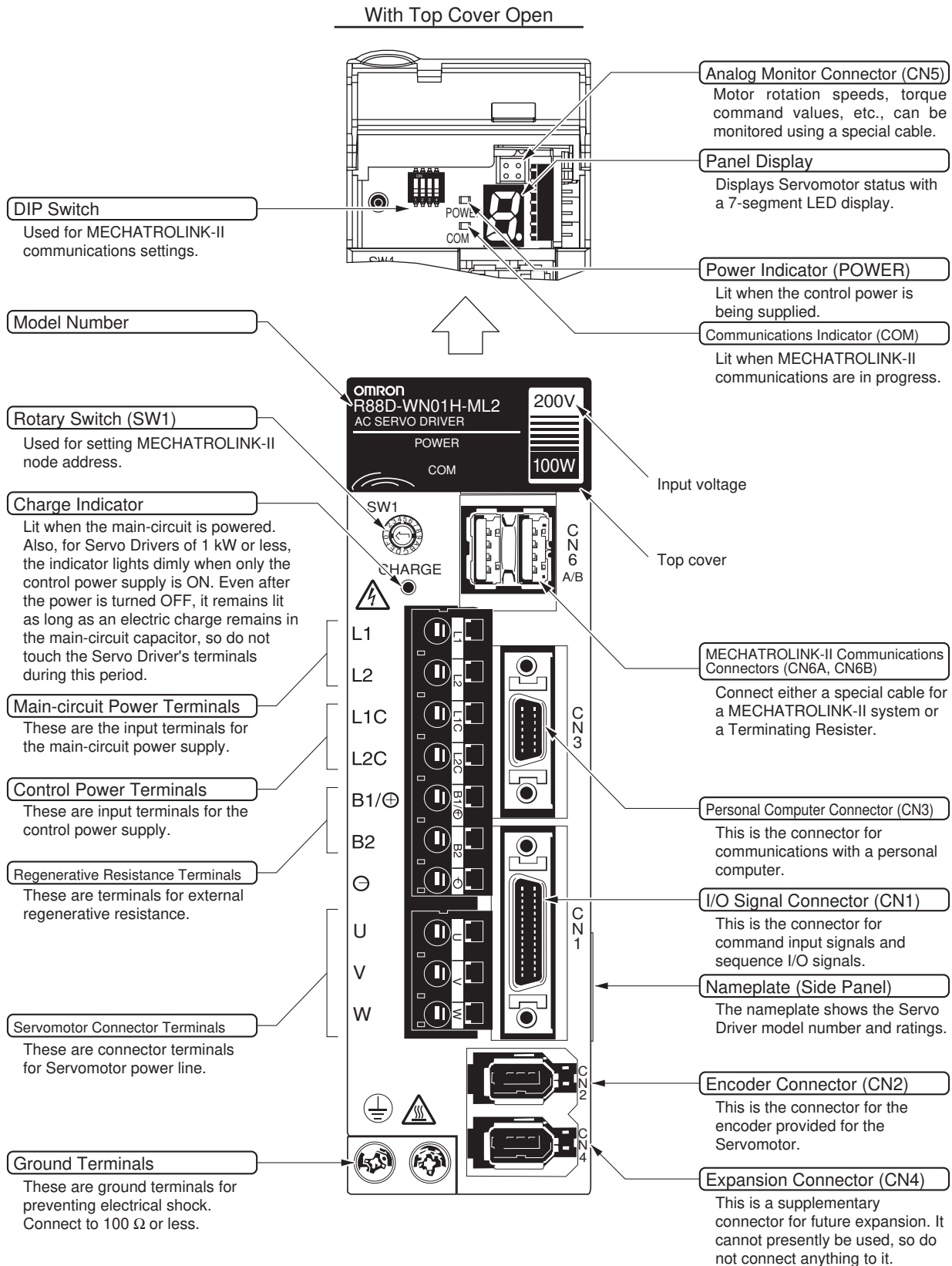



## 1-4 Applicable Standards and Models

### ■ EC Directives

EC Directive	Product	Applicable standard	Remarks
Low Voltage	AC Servo Drivers	EN50178	Safety requirements for electrical equipment for measurement, control, and laboratory use.
	AC Servomotors	IEC60034-8 EN60034-1, -5, -9	Rotating electrical machines.
EMC	AC Servo Drivers and AC Servomotors	EN55011 class A group 1	Limits and methods for measuring radio disturbance characteristics of industrial, scientific, and medical (ISM) radio-frequency equipment.
		EN61000-6-2	Electromagnetic compatibility generic immunity standard in industrial environments

**Note** Installation under the conditions specified in *3-2-5 Wiring for Conformity to EMC Directives* is required to conform to EMC Directives.

### ■ UL/cUL Standards

Standards	Product	Applicable standard	File No.	Remarks
UL	AC Servo Drivers	UL508C	E179149	Power conversion equipment
	AC Servomotors	UL1004	E179189	Electric motors
cUL	AC Servo Drivers	cUL C22.2 No. 14	E179149	Industrial control equipment
	AC Servomotors	cUL C22.2 No. 100	E179189	Motors and generators

## 1-5 System Block Diagrams

### ■ 100 V AC: R88D-WNA5L-ML2/WN01L-ML2/-WL02L-ML2/-WN04L-ML2

Single-phase 100 to 115 V  
+10%/-15% (50/60 Hz)

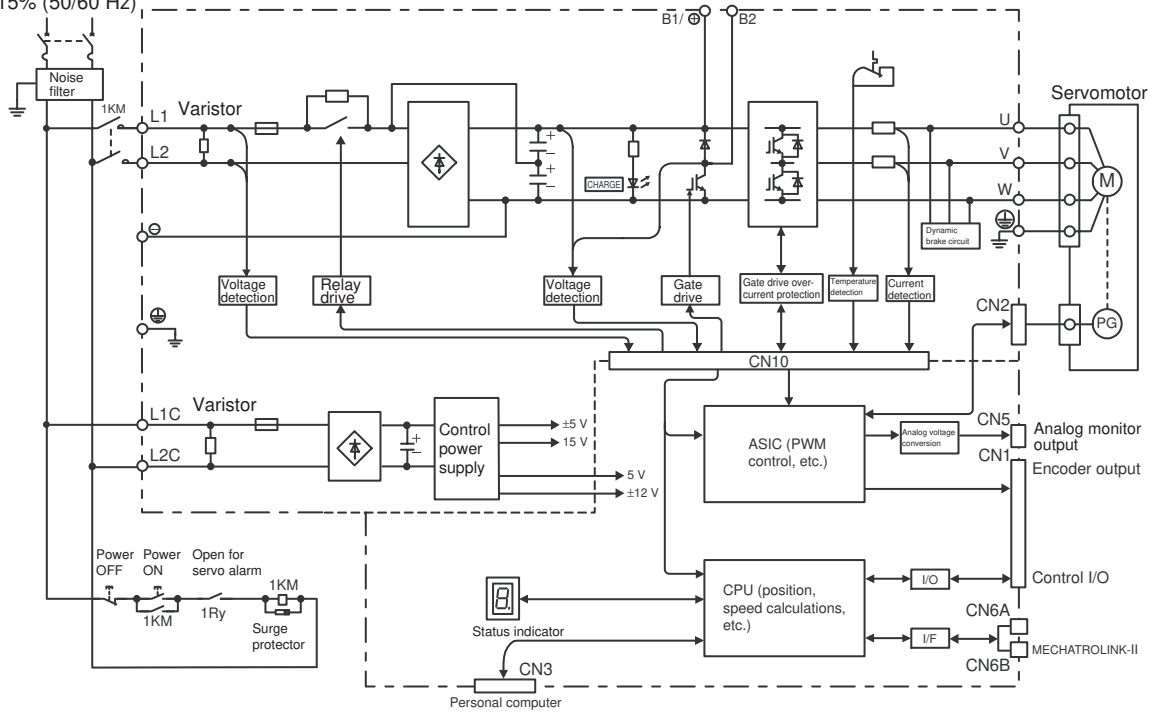

### ■ 200 V AC: R88D-WNA5H-ML2/WN01H-ML2/-WL02H-ML2/-WN04H-ML2

Single-phase 200 to 230 V  
+10%/-15% (50/60 Hz)

