



Chipsmall Limited consists of a professional team with an average of over 10 year of expertise in the distribution of electronic components. Based in Hongkong, we have already established firm and mutual-benefit business relationships with customers from,Europe,America and south Asia,supplying obsolete and hard-to-find components to meet their specific needs.

With the principle of “Quality Parts,Customers Priority,Honest Operation,and Considerate Service”,our business mainly focus on the distribution of electronic components. Line cards we deal with include Microchip,ALPS,ROHM,Xilinx,Pulse,ON,Everlight and Freescale. Main products comprise IC,Modules,Potentiometer,IC Socket,Relay,Connector.Our parts cover such applications as commercial,industrial, and automotives areas.

We are looking forward to setting up business relationship with you and hope to provide you with the best service and solution. Let us make a better world for our industry!



## Contact us

Tel: +86-755-8981 8866 Fax: +86-755-8427 6832

Email & Skype: info@chipsmall.com Web: www.chipsmall.com

Address: A1208, Overseas Decoration Building, #122 Zhenhua RD., Futian, Shenzhen, China



# REAL TIME CLOCK MODULE (I<sup>2</sup>C-Bus) For Automotive

Extended operating temperature range (+125°C)

## RA - 8565 SA

- Built in frequency adjusted 32.768 kHz crystal.
- Interface Type : I<sup>2</sup>C-Bus Interface (400 kHz)
- Wide operating voltage range : 1.8 V to 5.5 V
- Wide voltage for timekeeping. : 1.7 V to 5.5 V
- Ta = -40 °C to +125 °C
- Extended operating temperature range : -40 °C to +125 °C
- 32.768 kHz frequency output function : N-ch Open drain output  
With Control Pin
- The various functions include full calendar, alarm, timer, etc.
- Applications : Car audio, Car navigation system, Clock, ECU sub clock
- Conforms to AEC-Q200
- \* The I<sup>2</sup>C-Bus is a trademark of NXP Semiconductors



Product Number (Please contact us)  
RA-8565SA : Q41A86552xxx00

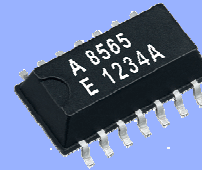

Actual size



### Block diagram

### Overview

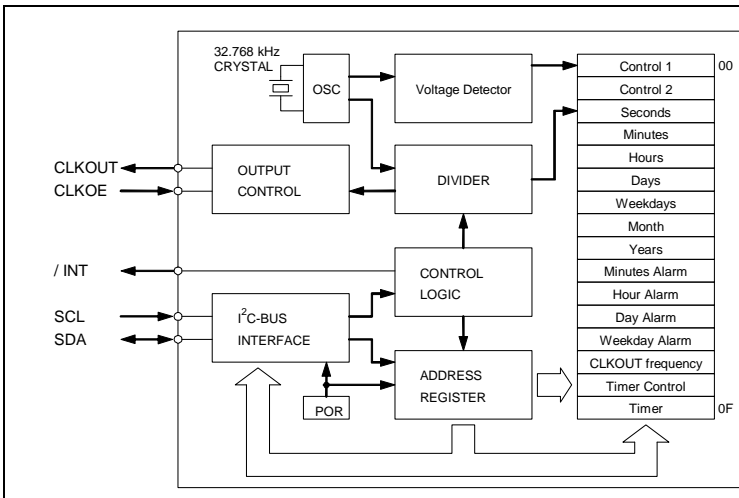

- Wide operating temperature range for automotive
  - -40 °C to +125 °C
- Clocking-status detection function
  - It can judge the validity of data after backup operation return by a status of VL-bit.
- 32.768 kHz frequency output function
  - CLKOUT pin output (N-ch Open Drain output )
  - Output frequency can be selected as 32.768 kHz, 1024 Hz, 32 Hz, or 1 Hz.
- The various interrupt function
  - Timer function can be set up between 1/4096 second and 255 minutes.
  - Alarm function can be set to day of week, day, hour, or minute.

### Pin Function

### Terminal connection / External dimensions (Unit:mm)

Signal Name	Directions	Functions
SCL	Input	Serial clock input.
SDA	Bi-directional	Data input and output.
CLKOUT	Output	The CLKOUT pin is a clock output ( open drain output ) pin with control output. ( Output frequency can be selected as 32.768 kHz, 1024 Hz, 32 Hz, or 1 Hz. )
CLKOE	Input	The CLKOE pin is an input pin used to control the output mode of the CLKOUT output pin. During the initial power-on ( when power is applied from 0 V ) , if the CLKOE input pin is at high level ( = H ) , the power-on reset function selects 32.768 kHz as the frequency.
/INT	Output	Interrupts output by Alarm and Timer events. ( Open drain output )
V <sub>DD</sub>	-	Connected to a positive power supply.
GND	-	Connected to a ground.

#### RA - 8565 SA

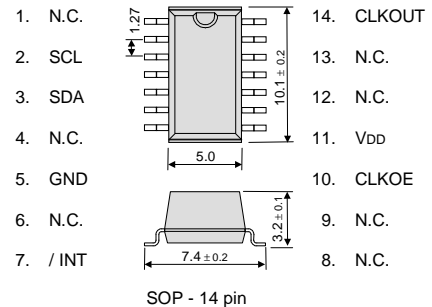

The metal case inside of the molding compound may be exposed on the top or bottom of this product. This purely cosmetic and does not have any effect on quality, reliability or electrical specs.

### Specifications (characteristics)

\* Refer to application manual for details.

#### Recommended Operating Conditions

Item	Symbol	Conditions	Min.	Typ.	Max.	unit
Operating voltage	V <sub>DD</sub>	-	1.8	3.0	5.5	V
Timekeeper voltage	V <sub>CLK</sub>	-	1.7	3.0	5.5	V
Operating temperature	T <sub>OPR</sub>	-	-40	+25	+125	°C

#### Frequency characteristics

Item	Symbol	Conditions	Rating	unit
Frequency stability	$\Delta f / f$	T <sub>a</sub> = +25 °C V <sub>DD</sub> = 3.0 V	B: 5 ± 23 <sup>*1</sup>	× 10 <sup>-6</sup>
Oscillation start up time	t <sub>STA</sub>	T <sub>a</sub> = +25 °C V <sub>DD</sub> = 1.8 V	1.5 Max.	s
		T <sub>a</sub> = -40 °C to +125 °C V <sub>DD</sub> = 3.0 V	3 Max.	s

\*1) Equivalent to 1 minutes of monthly deviation.

#### Current consumption under backup mode.

Item	Symbol	Conditions	Min.	Typ.	Max.	unit	
Standby current.	I <sub>bk</sub>	f <sub>SCL</sub> = 0 Hz CLKOE = LOW	+125 °C	-	1.10	1.8	μA
		V <sub>DD</sub> = 5 V	-40 °C to +85 °C	-	0.60	1.2	
		f <sub>SCL</sub> = 0 Hz CLKOE = LOW	+125 °C	-	1.00	1.6	μA
		V <sub>DD</sub> = 3 V	-40 °C to +85 °C	-	0.55	1.0	



## PROMOTION OF ENVIRONMENTAL MANAGEMENT SYSTEM CONFORMING TO INTERNATIONAL STANDARDS

At Seiko Epson, all environmental initiatives operate under the Plan-Do-Check-Action (PDCA) cycle designed to achieve continuous improvements. The environmental management system (EMS) operates under the ISO 14001 environmental management standard.

All of our major manufacturing and non-manufacturing sites, in Japan and overseas, completed the acquisition of ISO 14001 certification.

ISO 14000 is an international standard for environmental management that was established by the International Standards Organization in 1996 against the background of growing concern regarding global warming, destruction of the ozone layer, and global deforestation.





## WORKING FOR HIGH QUALITY

In order provide high quality and reliable products and services than meet customer needs,

Seiko Epson made early efforts towards obtaining ISO9000 series certification and has acquired ISO9001 for all business establishments in Japan and abroad. We have also acquired ISO/TS 16949 certification that is requested strongly by major automotive manufacturers as standard.

ISO/TS16949 is the international standard that added the sector-specific supplemental requirements for automotive industry based on ISO9001.

### ► Explanation of the mark that are using it for the catalog

	► Pb free.
	► Complies with EU RoHS directive. *About the products without the Pb-free mark. Contains Pb in products exempted by EU RoHS directive. (Contains Pb in sealing glass, high melting temperature type solder or other.)
	► Designed for automotive applications such as Car Multimedia, Body Electronics, Remote Keyless Entry etc.
	► Designed for automotive applications related to driving safety (Engine Control Unit, Air Bag, ESC etc ).

## Notice

- This material is subject to change without notice.
- Any part of this material may not be reproduced or duplicated in any form or any means without the written permission of Seiko Epson.
- The information about applied data, circuitry, software, usage, etc. written in this material is intended for reference only. Seiko Epson does not assume any liability for the occurrence of customer damage or infringing on any patent or copyright of a third party. This material does not authorize the licensing for any patent or intellectual copyrights.
- When exporting the products or technology described in this material, you should comply with the applicable export control laws and regulations and follow the procedures required by such laws and regulations.
- You are requested not to use the products (and any technical information furnished, if any) for the development and/or manufacture of weapon of mass destruction or for other military purposes. You are also requested that you would not make the products available to any third party who may use the products for such prohibited purposes.
- These products are intended for general use in electronic equipment. When using them in specific applications that require extremely high reliability, such as the applications stated below, you must obtain permission from Seiko Epson in advance.  
/ Space equipment (artificial satellites, rockets, etc.) / Transportation vehicles and related (automobiles, aircraft, trains, vessels, etc.) / Medical instruments to sustain life / Submarine transmitters / Power stations and related / Fire work equipment and security equipment / traffic control equipment / and others requiring equivalent reliability.
- All brands or product names mentioned herein are trademarks and/or registered trademarks of their respective.