



Chipsmall Limited consists of a professional team with an average of over 10 year of expertise in the distribution of electronic components. Based in Hongkong, we have already established firm and mutual-benefit business relationships with customers from,Europe,America and south Asia,supplying obsolete and hard-to-find components to meet their specific needs.

With the principle of "Quality Parts,Customers Priority,Honest Operation,and Considerate Service",our business mainly focus on the distribution of electronic components. Line cards we deal with include Microchip,ALPS,ROHM,Xilinx,Pulse,ON,Everlight and Freescale. Main products comprise IC,Modules,Potentiometer,IC Socket,Relay,Connector.Our parts cover such applications as commercial,industrial, and automotives areas.

We are looking forward to setting up business relationship with you and hope to provide you with the best service and solution. Let us make a better world for our industry!



Contact us

Tel: +86-755-8981 8866 Fax: +86-755-8427 6832

Email & Skype: info@chipsmall.com Web: www.chipsmall.com

Address: A1208, Overseas Decoration Building, #122 Zhenhua RD., Futian, Shenzhen, China



Ultra-Low Power sub-1 GHz Radio Module platform

Product Description

The RC18x0 Radio Module platforms are a series of compact surface-mounted ultra-low power RF modules based on the CC1310 system-on-chip from Texas Instruments. The modules include a low power RF transceiver compliant to IEEE 802.15.4g and wireless M-Bus standard.

The complete shielded module is only 12.7 x 25.4 x 3.5 mm and covers both 868 MHz and 915 MHz band.

Applications

- Internet of Things (IoT) IP sensor networks (6LoWPAN)
- Smart Metering / AMR / AMI
 - Electricity, gas, water and heat meters
- Wireless sensor networks/Building Automation
- Custom application

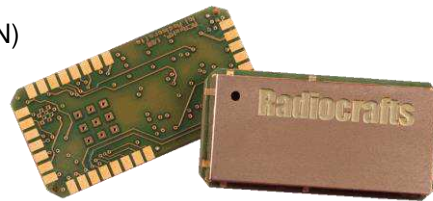

Features

- 12.7 x 25.4 x 3.5 mm compact shielded module for SMD mounting
- IEEE 802.15.4g compliant PHY
- Ultra-low power AMR® Cortex®- M3 for application
- 128 kB Flash memory, 20 kB SRAM
- 30 digital and analogue I/Os, 8 channel 12 bit ADC
- UART, SPI and debug interfaces
- On-board 32.768 kHz real time clock (RTC), 4 timers
- Wide input voltage range : 1.8 – 3.8 V
- AES-128 Security Module
- Optional 4 kB internal EEPROM
- Optional 256 kB internal SPI Flash memory (for OTA FW download)
- Conforms with EN 300 220 for Europe, ARIB for Japan, G.S.R. 542(E)/45(E) for India
- Designed for FCC compliance at 915 MHz band

Quick Reference Data (typical at 3.6V, 868 MHz, 50 kb/s)

Parameter	RC1880	Unit
Frequency band	862-930	MHz
Max output power	14	dBm
Sensitivity (BER 1%)	-110	dBm
Supply voltage	1.8 - 3.8	V
Current consumption, RX/TX	6.2 / 26.5	mA
Current consumption, Shutdown	185	nA
Flash memory	128	kB
RAM	20	kB
Internal EEPROM (optional)	4	kB
Internal SPI Flash(optional)	256	kB
Operating Temperature	-40 to +85	°C

Quick Product Introduction

The RC1880 series of modules is a flexible platform in the sub-1 GHz bands, suitable to comply with a large number of standards. Among other systems, the modules comply with IEEE 802.15.4g and Wireless M-Bus.

Using the module together with the TI-RTOS is a powerful combination to build any end application. Part of the TI-RTOS is programmed in ROM and using the operating system requires minimal of additional Flash. The modules are also supported by the open source operating system Contiki, through the CC1310 Contiki port.

Use these links to find more info on the alternative firmware:

- TI-RTOS <http://www.ti.com/tool/ti-rtos>
- Contiki <http://www.contiki-os.org/>

For more detailed info on developing firmware for RC1880 please see:

- RC18xx Firmware Development User Manual

Using a pre-qualified module is the fastest way to make a wireless product and shortest time to market. The embedded RF HW and MCU resources in a 100% RF tested and pre-qualified module shorten the qualification and approval process. No RF design or RF expertise is required to add powerful wireless networking to the product. In most cases you only need supply voltage (for example an external battery) and a sensor/actuator and the module can run the entire application.

About this document

This document is part of the documentation for the module. As the module contains CC1310, all documentation for CC1310 from Texas Instrument also applies for this product. This includes (but is not limited to):

- CC1310 SimpleLink™ Ultralow Power Sub-1-GHz Wireless MCU Data Sheet
- CC1310 SimpleLink™ Wireless MCU Silicon Errata
- CC13xx, CC26xx SimpleLink™ Wireless MCU Technical Reference Manual

Pin Assignment

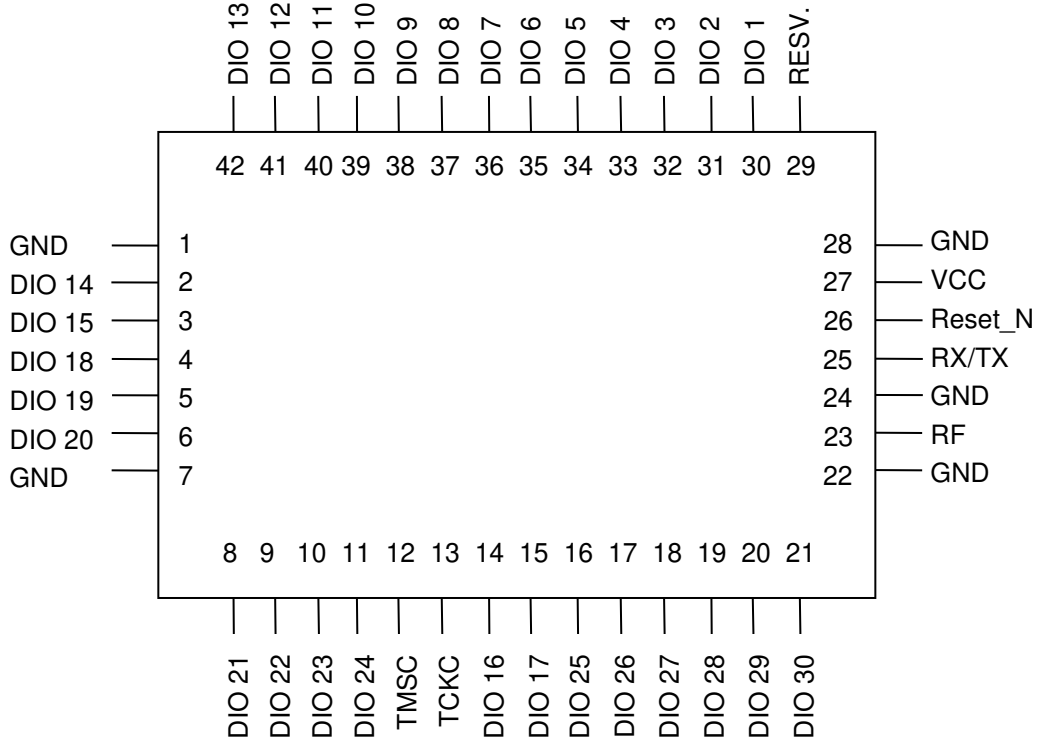

Pin Description

Pin no	Pin name	Description	CC1310 pin
1	GND	System ground	
2	DIO 14	Configurable I/O pin	20
3	DIO 15	Configurable I/O pin	21
4	DIO 18	Configurable I/O pin	28
5	DIO 19	Configurable I/O pin	29
6	DIO 20	Configurable I/O pin	30
7	GND	System ground	
8	DIO 21	Configurable I/O pin, I2C SDA internal EEPROM	31
9	DIO 22	Configurable I/O pin, I2C SCL internal EEPROM	32
10	DIO 23	Configurable I/O pin	36
11	DIO 24	Configurable I/O pin	37
12	TMSC	JTAG interface	24
13	TCKC	JTAG interface	25
14	DIO 16	Configurable I/O pin/JTAG TDO	26
15	DIO 17	Configurable I/O pin/JTAG TDI	27
16	DIO 25	Configurable I/O pin	38
17	DIO 26	Configurable I/O pin	39
18	DIO 27	Configurable I/O pin	40
19	DIO 28	Configurable I/O pin	41
20	DIO 29	Configurable I/O pin	42
21	DIO 30	Configurable I/O pin	43
22	GND	System ground	
23	RF	RF I/O connection to antenna	
24	GND	System ground	
25	RX/TX	Not connected	

26	RESET_N	Reset (Active low)	
27	VCC	Supply voltage	
28	GND	System ground	
29	RESV.	Reserved	
30	DIO 1	Configurable I/O pin, SPI CS for internal flash	6
31	DIO 2	Configurable I/O pin, SPI SO for internal flash	7
32	DIO 3	Configurable I/O pin, SPI SI for internal flash	8
33	DIO 4	Configurable I/O pin, SPI CLK for internal flash	9
34	DIO 5	Configurable I/O pin	10
35	DIO 6	Configurable I/O pin	11
36	DIO 7	Configurable I/O pin	12
37	DIO 8	Configurable I/O pin	14
38	DIO 9	Configurable I/O pin	15
39	DIO 10	Configurable I/O pin	16
40	DIO 11	Configurable I/O pin	17
41	DIO 12	Configurable I/O pin	18
42	DIO 13	Configurable I/O pin	19

Note 1: Pins 8 and 9 are suggested as I2C interface. They can be configured otherwise, but are connected to an optional internal EEPROM with I2C address = 000. It is recommended to leave these pins as I2C. Sensors and actuators or any other I2C device can be connected to these pins and accessed from the module.

Note 2: Pins 30 to 33 are suggested as SPI interface. They can be configured otherwise, but are connected to an optional internal SPI Flash memory.

Block Diagram

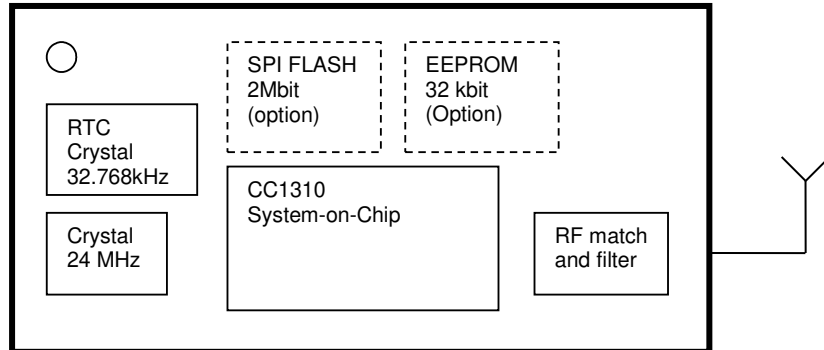

Programming and debugging Interface

Refer to CC1310 documentation.

Optional memory

There are 2 optional internal memory components in the module.

There is a 4kB I2C EEPROM, intended for storing application data that need frequent write access. (E.g. data logging). The I2C address of the EEPROM is 0b000.

There is also a 256 kB SPI Flash memory, intended to support over the air (OTA) firmware upgrade. The size of the Flash is twice the code memory, allowing both new firmware and backup firmware to be stored.

Crystal tuning

The CC1310 chip has internal tuning capacitor for 24 MHz crystal. The tuning capacitor for on-module crystal is 9pF for HW 1.0 and later. This means the internal tuning in CC1310 shall be set to zero. For other revision please see Product Change Notificaiton.

```
SET_CCFG_MODE_CONF_XOSC_CAPARRAY_DELTA = 0x00
```

Regulatory Compliance Information

The use of RF frequencies and maximum allowed transmitted RF power is limited by national regulations. The RC1840 and RC1880 have been designed to comply with world wide regulations (RED directive 2014/53/EU in Europe, ARIB for Japan, G.S.R. 542(E)/45(E) for India, and FCC for the US). Final approval needs to be done with the end product embedded firmware.

Mechanical Drawing

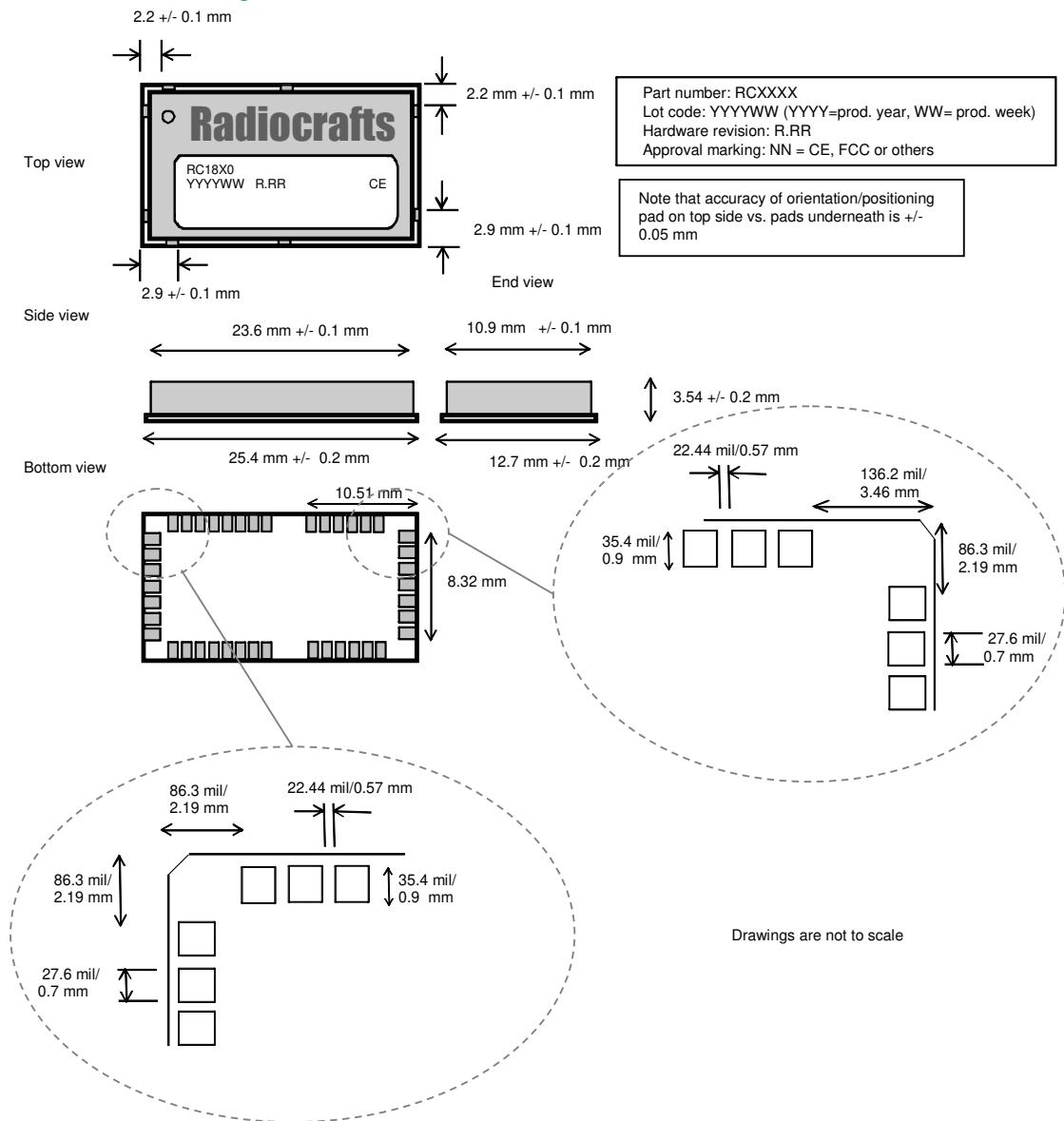

Mechanical Dimensions

The module size is 12.7 x 25.4 x 3.5 mm.

Carrier Tape and Reel Specification

Carrier tape and reel is in accordance with EIA Specification 481.

Tape width	Component pitch	Hole pitch	Reel diameter	Units per reel
44 mm	16 mm	4 mm	13"	Max 1000

PCB Layout Recommendations

The recommended layout pads for the module are shown in the figure below.

The circle in upper left corner is an orientation mark only, and should not be a part of the copper pattern.

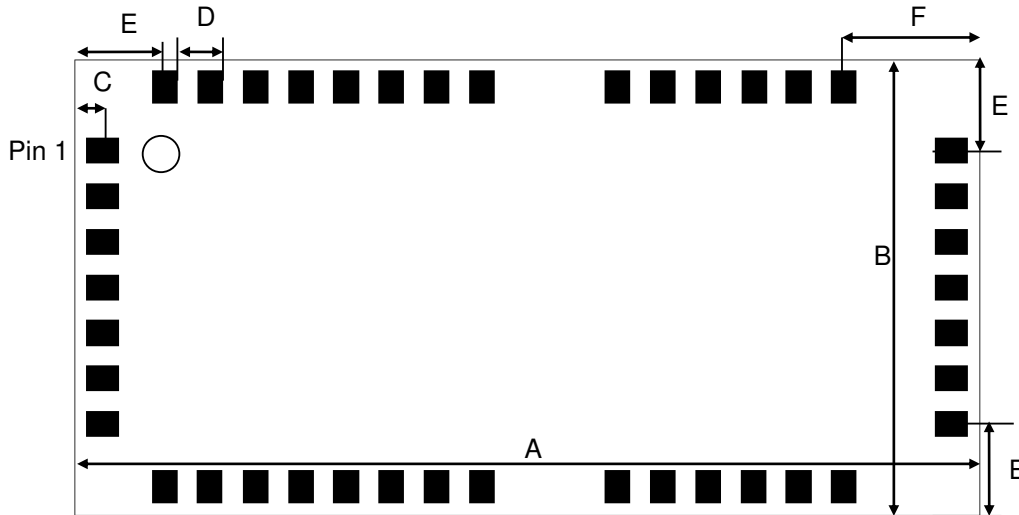

Dimension	Length [mm] (mil)	Comment
A	25.4 (1000)	Length of module
B	12.7 (500)	Width of module
C	0.79 (31)	Module edge vs centre of pad (Valid for all pads)
D	1.27 (50)	Pad to pad distance
E	2.54 (100)	Modul edge to pad (centre)
F	3.81 (150)	Modul edge to pad (centre)
G	0.9 (35.4)	Length of pad/recommend footprint pad
H	0.7 (27.6)	Width of pad/recommend footprint pad

Recommended pad design is shown below.

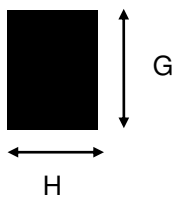

The recommended footprint for solder soldering is a one-to-one mapping between the LGA pad on module and the footprint.

For prototype build a solder hot plate is recommended. If the prototype is soldered manually by soldering iron, it is recommend to extend the pads of the footprint out from the module to make is accessible for a soldering iron.

A PCB with two or more layers and with a solid ground plane in one of the inner- or bottom layer(s) is recommended. All GND-pins of the module shall be connected to this ground plane with vias with shortest possible routing, one via per GND-pin.

Routing or vias under the module is not recommended as per IPC-recommendation. If any routing or vias is required under the module, the routing and vias must be covered with solder resist to prevent short circuiting of the test pads. It is recommended that vias are tented.

Reserved pins should be soldered to the pads, but the pads must be left floating electrically (no connection).

Note that Radiocrafts technical support team is available for free-of-charge schematic- and layout review of your design.

Soldering Profile Recommendation

JEDEC standard IPC/JEDEC J-STD-020D.1 (page 7 and 8), Pb-Free Assembly is recommended.

The standard requires that the heat dissipated in the "surroundings" on the PCB is taken into account. The peak temperature should be adjusted so that it is within the window specified in the standard for the actual motherboard.

Aperture for paste stencil is normally areal-reduced by 20-35%, please consult your production facility for best experience aperture reduction. Nominal stencil thickness of 0.1 - 0.12 mm recommended.

Absolute Maximum Ratings

Parameter	Min	Max	Unit
Supply voltage, VCC	-0.3	4.1	V
Voltage on any pin	-0.3	VCC + 0.3 (max 4.1)	V
Input RF level		10	dBm
Storage temperature	-40	150	°C
Operating temperature	-40	85	°C

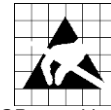

Caution ! ESD sensitive device.
Precaution should be used when handling the device in order to prevent permanent damage.

Under no circumstances the absolute maximum ratings given above should be violated. Stress exceeding one or more of the limiting values may cause permanent damage to the device.

Electrical Specifications

T=25°C, VCC = 3.3V, 868 MHz, 50 ohm if nothing else stated.

Parameter	Min	Typ.	Max	Unit	Condition / Note
Operating frequency	862		930	MHz	
Input/output impedance		50		Ohm	
Data rate		50		kbit/s	
Frequency stability			+/- 10 +/-15 +20/-26	ppm ppm ppm	Initially Temperature drift -30°-85° Temperature drift -40°-85° Other stability option available on request
Transmit power	-10		14	dBm	Programmable from firmware @ max output power
Harmonics 2 nd harmonic 3 rd harmonic		-52 -58			
Spurious emission, TX, 868 MHz 30 – 1000 MHz 30 – 1000 MHz 1-12.75 GHz			-59 -51 -37	dBm dBm dBm	EN 300 220 restricted band EN 300 220 un-restricted band
Spurious emission, TX, 915 MHz 30 – 88 MHz 88 – 960 MHz 960 – 2390 MHz 1-12.75 GHz		< -66 < -65 < -55 < -43			Within FCC restricted band Within FCC restricted band Within FCC restricted band Outside FCC restricted band
Sensitivity		-110		dBm	BER = 1%, 50 kbps 2 FSK, IEEE 802.15.4g mandatory settings
Saturation		10		dBm	
Spurious emission, RX 1-12.75 GHz		-70		dBm	Complies with EN 300 320 CRF47 Part 15 and ARIB STD-T66
Supply voltage Recommended operating voltage	1.8		3.8	V	
Current consumption, RX		6.2		mA	VCC = 3.6V
Current consumption, TX		26.5		mA	Output power 14 dBm, VCC = 3.6V
Current consumption, Shutdown Sleep, RTC based on Crystal		185 700		nA nA	
RAM memory		20		kB	
SoC internal Flash memory		128		kB	
SPI Flash memory		256		kB	Optional
I2C EEPROM		4		kB	Optional
MCU clock frequency		48		MHz	
MCU low frequency crystal		32.768		kHz	Optional
Antenna VSWR		<2:1	3:1		

Ordering Information

Ordering Part Number	Description
RC1880[CEF]	865/868/915 MHz module variant

CEF indicate optional mounted features.

- C Include 32.768 kHz RTC crystal
- E Include optional I2C EEPROM
- F Include optional 256 kB flash

The different options can be combined and a module including all three options are named RC1880-CEF.

RC1880 and RC1880-CEF are the standard variants and normally on stock. Other variants are available on request. Please contact Radiocrafts sales for non-standard variants.

Document Revision History

Document Revision	Changes
1.0	First release
1.1	Updated number on current consumption
1.2	Added info on variant part numbers Updated frequency accuracy Valid for HW rev 1.0 and later. For other variants see Product Change Notification

Product Status and Definitions

Current Status	Data Sheet Identification	Product Status	Definition
	Advance Information	Planned or under development	This data sheet contains the design specifications for product development. Specifications may change in any manner without notice.
X	Preliminary	Engineering Samples and First Production	This data sheet contains preliminary data, and supplementary data will be published at a later date. Radiocrafts reserves the right to make changes at any time without notice in order to improve design and supply the best possible product.
	No Identification Noted	Full Production	This data sheet contains final specifications. Radiocrafts reserves the right to make changes at any time without notice in order to improve design and supply the best possible product.
	Not recommended for new designs	Last time buy available	Product close to end of lifetime
	Obsolete	Not in Production Optionally accepting order with Minimum Order Quantity	This data sheet contains specifications on a product that has been discontinued by Radiocrafts. The data sheet is printed for reference information only.

Disclaimer

Radiocrafts AS believes the information contained herein is correct and accurate at the time of this printing. However, Radiocrafts AS reserves the right to make changes to this product without notice. Radiocrafts AS does not assume any responsibility for the use of the described product; neither does it convey any license under its patent rights, or the rights of others. The latest updates are available at the Radiocrafts website or by contacting Radiocrafts directly.

As far as possible, major changes of product specifications and functionality, will be stated in product specific Errata Notes published at the Radiocrafts website. Customers are encouraged to check regularly for the most recent updates on products and support tools.

Trademarks

All trademarks, registered trademarks and product names are the sole property of their respective owners.

Life Support Policy

This Radiocrafts product is not designed for use in life support appliances, devices, or other systems where malfunction can reasonably be expected to result in significant personal injury to the user, or as a critical component in any life support device or system whose failure to perform can be reasonably expected to cause the failure of the life support device or system, or to affect its safety or effectiveness. Radiocrafts AS customers using or selling these products for use in such applications do so at their own risk and agree to fully indemnify Radiocrafts AS for any damages resulting from any improper use or sale.

© 2017, Radiocrafts AS. All rights reserved.

Contact Information

Web site: www.radiocrafts.com

Email: radiocrafts@radiocrafts.com

Address:

Radiocrafts AS

Sandakerveien 64

NO-0484 OSLO

NORWAY

Tel: +47 4000 5195

Fax: +47 22 71 29 15

E-mail: sales@radiocrafts.com