



Chipsmall Limited consists of a professional team with an average of over 10 year of expertise in the distribution of electronic components. Based in Hongkong, we have already established firm and mutual-benefit business relationships with customers from,Europe,America and south Asia,supplying obsolete and hard-to-find components to meet their specific needs.

With the principle of “Quality Parts,Customers Priority,Honest Operation,and Considerate Service”,our business mainly focus on the distribution of electronic components. Line cards we deal with include Microchip,ALPS,ROHM,Xilinx,Pulse,ON,Everlight and Freescale. Main products comprise IC,Modules,Potentiometer,IC Socket,Relay,Connector.Our parts cover such applications as commercial,industrial, and automotives areas.

We are looking forward to setting up business relationship with you and hope to provide you with the best service and solution. Let us make a better world for our industry!



Contact us

Tel: +86-755-8981 8866 Fax: +86-755-8427 6832

Email & Skype: info@chipsmall.com Web: www.chipsmall.com

Address: A1208, Overseas Decoration Building, #122 Zhenhua RD., Futian, Shenzhen, China



10V Drive Nch MOSFET

RCD050N20

● Structure

Silicon N-channel MOSFET

● Features

- 1) Low on-resistance.
- 2) High-speed switching.
- 3) Wide range of SOA.
- 4) Drive circuits can be simple.
- 5) Parallel use is easy.

● Application

Switching

● Packaging specifications

Type	Package	Taping
	Code	TL
	Basic ordering unit (pieces)	2500
RCD050N20		○

● Absolute maximum ratings (Ta = 25°C)

Parameter	Symbol	Limits	Unit	
Drain-source voltage	V_{DSS}	200	V	
Gate-source voltage	V_{GSS}	±30	V	
Drain current	Continuous	I_D *3	±5	A
	Pulsed	I_{DP} *1	±20	A
Source current (Body Diode)	Continuous	I_S *3	5	A
	Pulsed	I_{SP} *1	20	A
Avalanche current	I_{AS} *2	2.5	A	
Avalanche energy	E_{AS} *2	1.83	mJ	
Power dissipation	P_D *4	20	W	
Channel temperature	T_{ch}	150	°C	
Range of storage temperature	T_{stg}	-55 to +150	°C	

*1 $P_w \leq 10 \mu s$, Duty cycle $\leq 1\%$

*2 $L = 500 \mu H$, $V_{DD} = 50V$, $R_G = 25 \Omega$, $T_{ch} = 25^\circ C$

*3 Limited only by maximum temperature allowed.

*4 $T_C = 25^\circ C$

● Thermal resistance

Parameter	Symbol	Limits	Unit
Channel to Case	$R_{th}(ch-c)$	6.25	°C / W

* $T_C = 25^\circ C$

* Limited only by maximum temperature allowed.

● Dimensions (Unit : mm)

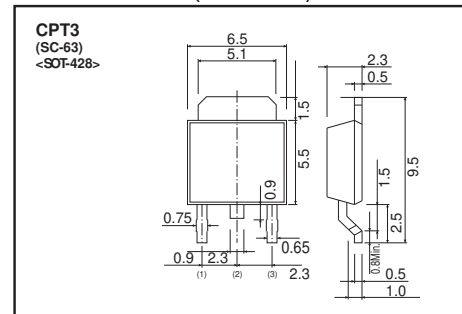

● Inner circuit

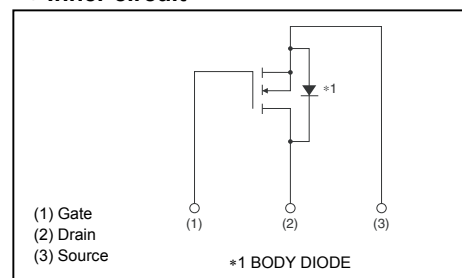

● Electrical characteristics (Ta = 25°C)

Parameter	Symbol	Min.	Typ.	Max.	Unit	Conditions
Gate-source leakage	I_{GSS}	-	-	±100	nA	$V_{GS}=\pm 30V, V_{DS}=0V$
Drain-source breakdown voltage	$V_{(BR)DSS}$	200	-	-	V	$I_D=1mA, V_{GS}=0V$
Zero gate voltage drain current	I_{DSS}	-	-	10	μA	$V_{DS}=200V, V_{GS}=0V$
Gate threshold voltage	$V_{GS(th)}$	3.25	-	5.25	V	$V_{DS}=10V, I_D=1mA$
Static drain-source on-state resistance	$R_{DS(on)*}$	-	470	618	mΩ	$I_D=2.5A, V_{GS}=10V$
Forward transfer admittance	$ Y_{fs} ^*$	1	2	-	S	$V_{DS}=10V, I_D=2.5A$
Input capacitance	C_{iss}	-	380	-	pF	$V_{DS}=25V$
Output capacitance	C_{oss}	-	30	-	pF	$V_{GS}=0V$
Reverse transfer capacitance	C_{rss}	-	15	-	pF	$f=1MHz$
Turn-on delay time	$t_{d(on)}^*$	-	17	-	ns	$V_{DD}\approx 100V, I_D=2.5A$
Rise time	t_r^*	-	15	-	ns	$V_{GS}=10V$
Turn-off delay time	$t_{d(off)}^*$	-	22	-	ns	$R_L=40\Omega$
Fall time	t_f^*	-	11	-	ns	$R_G=10\Omega$
Total gate charge	Q_g^*	-	9.0	-	nC	$V_{DD}\approx 100V, I_D=5A$
Gate-source charge	Q_{gs}^*	-	3.5	-	nC	$V_{GS}=10V$
Gate-drain charge	Q_{gd}^*	-	3.5	-	nC	

*Pulsed

● Body diode characteristics (Source-Drain)

Parameter	Symbol	Min.	Typ.	Max.	Unit	Conditions
Forward Voltage	V_{SD}^*	-	-	1.5	V	$I_s=5A, V_{GS}=0V$

*Pulsed

●Electrical characteristic curves (Ta=25°C)

Fig.1 Typical Output Characteristics (I)

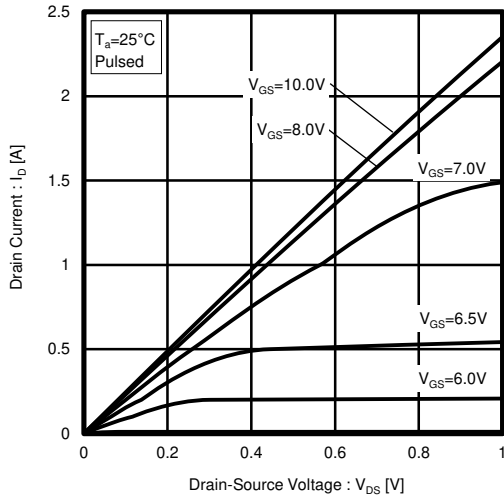

Fig.2 Typical Output Characteristics (II)

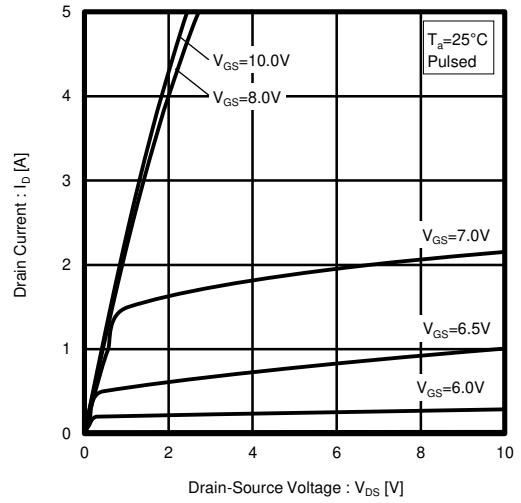

Fig.3 Typical Transfer Characteristics

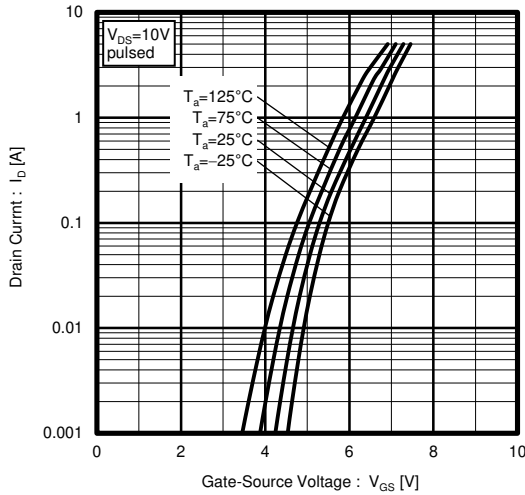

Fig.4 Gate Threshold Voltage vs. Channel Temperature

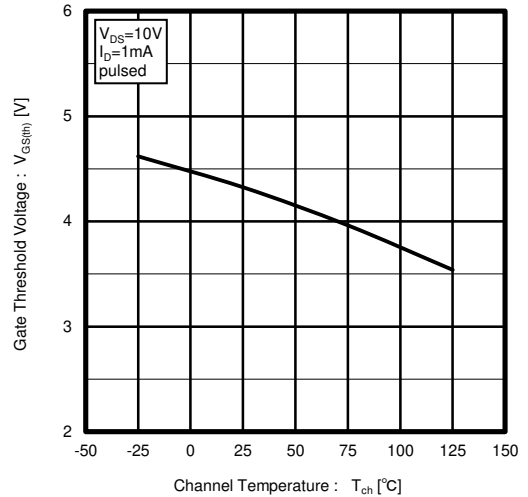

Fig.5 Static Drain-Source On-State Resistance vs. Drain Current

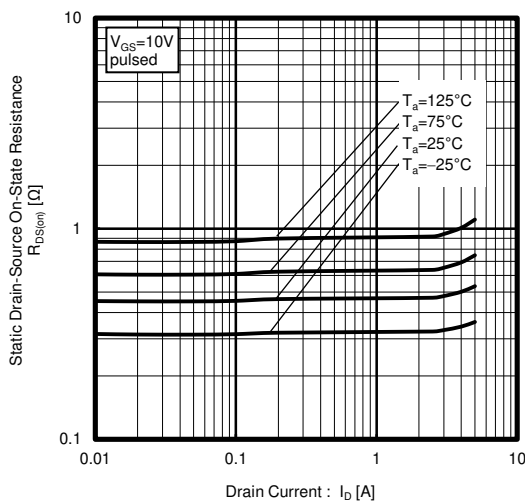

Fig.6 Static Drain-Source On-State Resistance vs. Channel Temperature

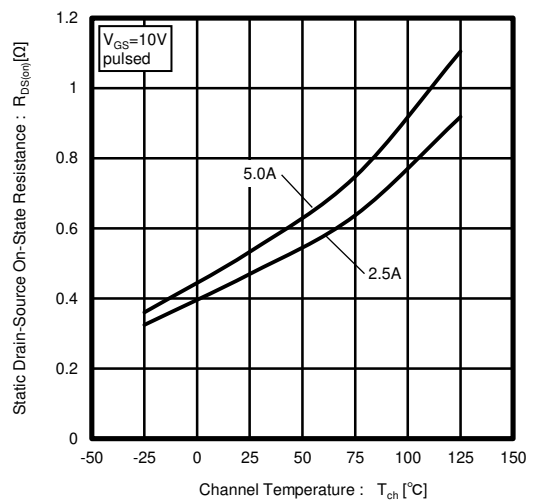

Fig.7 Forward Transfer Admittance vs. Drain Current

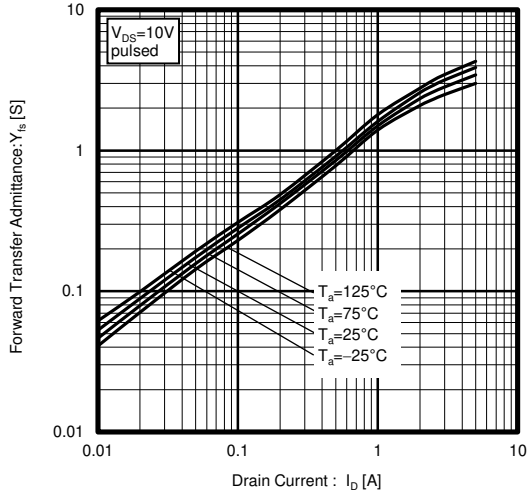

Fig.8 Source Current vs. Source-Drain Voltage

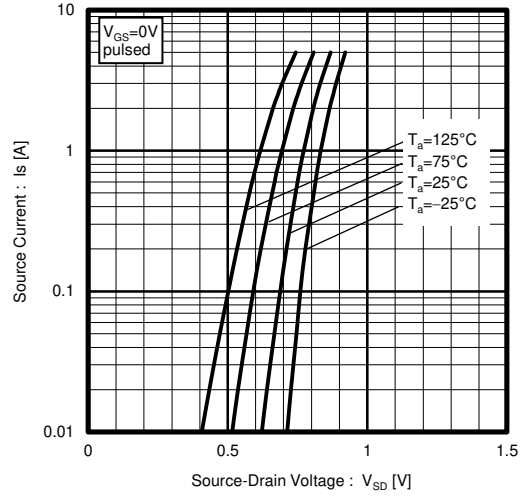

Fig.9 Static Drain-Source On-State Resistance vs. Gate-Source Voltage

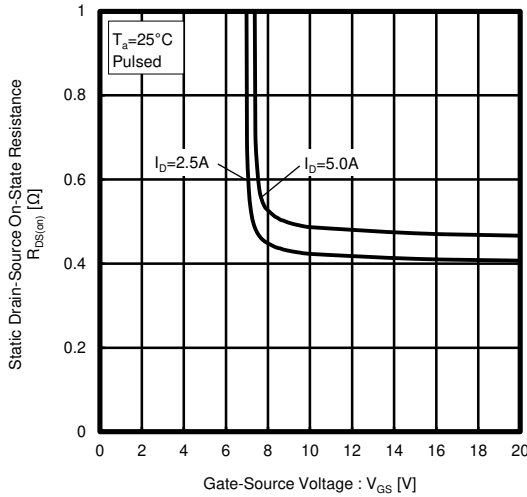

Fig.10 Switching Characteristics

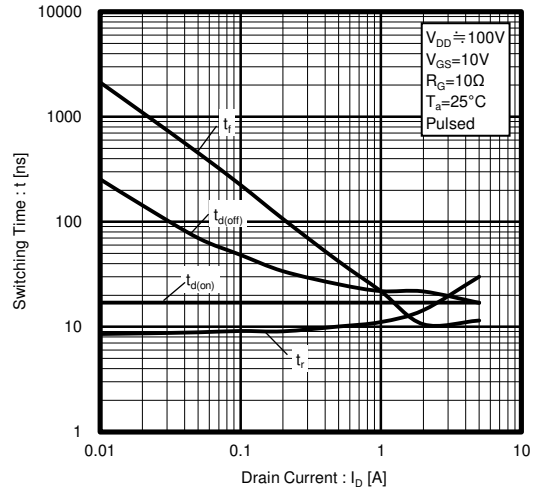

Fig.11 Dynamic Input Characteristics

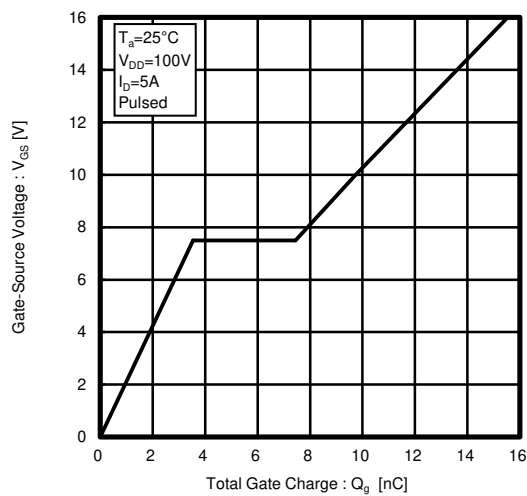

Fig.12 Typical Capacitance vs. Drain-Source Voltage

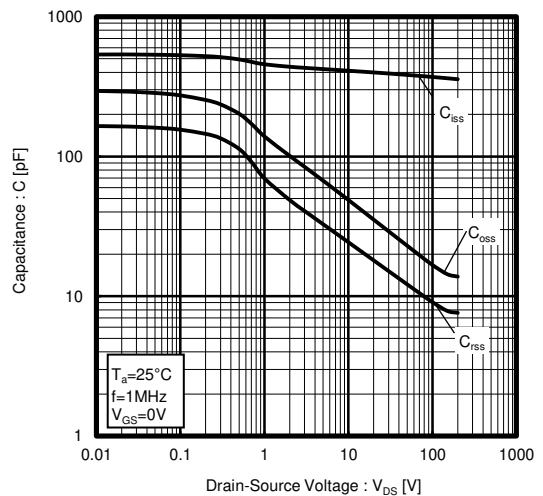

Fig.13 Maximum Safe Operating Area

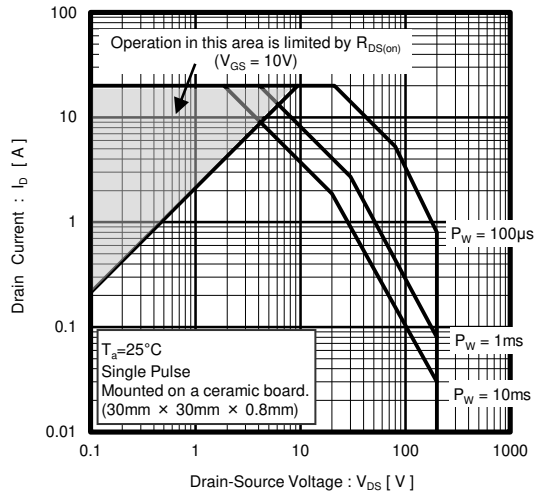
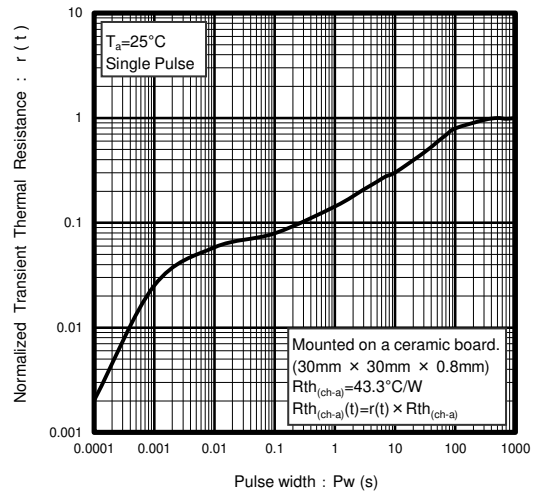

Fig.14 Normalized Transient Thermal Resistance v.s. Pulse Width



● Measurement circuits

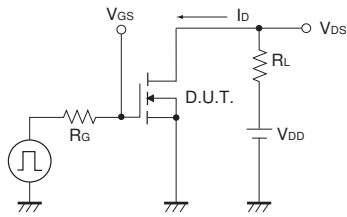

Fig.1-1 Switching Time Measurement Circuit

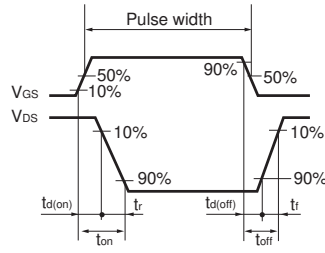

Fig.1-2 Switching Waveforms

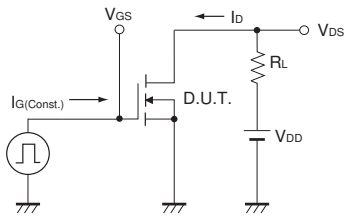

Fig.2-1 Gate Charge Measurement Circuit

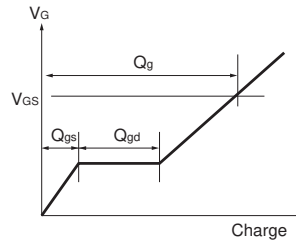

Fig.2-2 Gate Charge Waveform

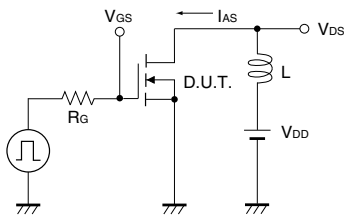

Fig.3-1 Avalanche Measurement Circuit

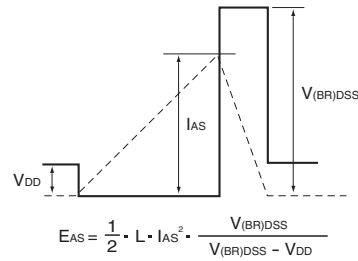

Fig.3-2 Avalanche Waveform

Notes

No copying or reproduction of this document, in part or in whole, is permitted without the consent of ROHM Co.,Ltd.

The content specified herein is subject to change for improvement without notice.

The content specified herein is for the purpose of introducing ROHM's products (hereinafter "Products"). If you wish to use any such Product, please be sure to refer to the specifications, which can be obtained from ROHM upon request.

Examples of application circuits, circuit constants and any other information contained herein illustrate the standard usage and operations of the Products. The peripheral conditions must be taken into account when designing circuits for mass production.

Great care was taken in ensuring the accuracy of the information specified in this document. However, should you incur any damage arising from any inaccuracy or misprint of such information, ROHM shall bear no responsibility for such damage.

The technical information specified herein is intended only to show the typical functions of and examples of application circuits for the Products. ROHM does not grant you, explicitly or implicitly, any license to use or exercise intellectual property or other rights held by ROHM and other parties. ROHM shall bear no responsibility whatsoever for any dispute arising from the use of such technical information.

The Products specified in this document are intended to be used with general-use electronic equipment or devices (such as audio visual equipment, office-automation equipment, communication devices, electronic appliances and amusement devices).

The Products specified in this document are not designed to be radiation tolerant.

While ROHM always makes efforts to enhance the quality and reliability of its Products, a Product may fail or malfunction for a variety of reasons.

Please be sure to implement in your equipment using the Products safety measures to guard against the possibility of physical injury, fire or any other damage caused in the event of the failure of any Product, such as derating, redundancy, fire control and fail-safe designs. ROHM shall bear no responsibility whatsoever for your use of any Product outside of the prescribed scope or not in accordance with the instruction manual.

The Products are not designed or manufactured to be used with any equipment, device or system which requires an extremely high level of reliability the failure or malfunction of which may result in a direct threat to human life or create a risk of human injury (such as a medical instrument, transportation equipment, aerospace machinery, nuclear-reactor controller, fuel-controller or other safety device). ROHM shall bear no responsibility in any way for use of any of the Products for the above special purposes. If a Product is intended to be used for any such special purpose, please contact a ROHM sales representative before purchasing.

If you intend to export or ship overseas any Product or technology specified herein that may be controlled under the Foreign Exchange and the Foreign Trade Law, you will be required to obtain a license or permit under the Law.



Thank you for your accessing to ROHM product informations.
More detail product informations and catalogs are available, please contact us.

ROHM Customer Support System

<http://www.rohm.com/contact/>

