



Chipsmall Limited consists of a professional team with an average of over 10 year of expertise in the distribution of electronic components. Based in Hongkong, we have already established firm and mutual-benefit business relationships with customers from,Europe,America and south Asia,supplying obsolete and hard-to-find components to meet their specific needs.

With the principle of “Quality Parts,Customers Priority,Honest Operation,and Considerate Service”,our business mainly focus on the distribution of electronic components. Line cards we deal with include Microchip,ALPS,ROHM,Xilinx,Pulse,ON,Everlight and Freescale. Main products comprise IC,Modules,Potentiometer,IC Socket,Relay,Connector.Our parts cover such applications as commercial,industrial, and automotives areas.

We are looking forward to setting up business relationship with you and hope to provide you with the best service and solution. Let us make a better world for our industry!



## Contact us

Tel: +86-755-8981 8866 Fax: +86-755-8427 6832

Email & Skype: info@chipsmall.com Web: www.chipsmall.com

Address: A1208, Overseas Decoration Building, #122 Zhenhua RD., Futian, Shenzhen, China



# Solid State Relays

## 1-Phase, Zero Cross or Instant On Switching

### 25 AAC, 230 VAC with LED and Built-in Transil

#### Types RF1A, RF1B



- AC switching Solid State Relay
- Switching through back to back thyristors
- Long lifetime through reduced stress on output chip
- Operational ratings: up to 280 VAC, 25 AAC
- Control voltage: 5 VDC, 12 VDC, 24 VDC
- LED for control status indication
- Integrated overvoltage protection on output
- Opto isolation input to output 3750 VAC
- 100k cycles endurance test according to UL508
- Pre-attached thermal interface to SSR backplate



## Product Description

The RF1 series provides a compact solid state switching solution suited for confined spaces. Long life time is ensured by the use of assembly technology that reduces stresses on the power semiconductors.

The RF1 series is suitable for resistive loads. The zero switching type (RF1A), switches ON when the voltage crosses zero. The instant-ON type

(RF1B), switches on when the control voltage is applied. Switch OFF occurs when current crosses zero.

Integrated transils provide protection against overvoltages. A green LED indicates presence of the control voltage. FASTON terminals enable fast installation. The RF1 is provided with pre-attached thermal interface ready for mounting on chassis or heatsink.

Specifications are stated at 25°C unless otherwise noted

## Ordering Key

**RF 1 A 23 D 25**

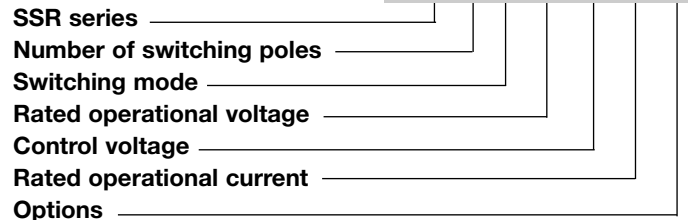

## Ordering Key

Switching mode	Rated voltage	Control voltage	Rated current*
RF1A: Zero Cross (ZC) RF1B: Instant On (IO)	23: 230 VAC (24 - 280 VAC), 50/60 Hz	L: 5 VDC M: 12 VDC D: 24 VDC	25: 25 AAC

## Selection Guide

Rated output voltage, Switching mode	Blocking voltage	Control voltage range	Rated operational current*
230 VAC, ZC	600 Vp	4.25 - 9.0 VDC 9.0 - 18.0 VDC 18.0 - 28.8 VDC	RF1A23L25 RF1A23M25 RF1A23D25
230 VAC, IO	600 Vp	4.5 - 9.0 VDC 11.0 - 18.0 VDC 18.0 - 28.8 VDC	RF1B23L25 RF1B23M25 RF1B23D25

\* Max. 25 AAC with suitable heatsink. Refer to Heatsink Selection tables.

## General Specifications

Latching voltage (across L-T)	≤ 20 V	Rated impulse withstand voltage, $U_{imp}$	4 kV (1.2/50 $\mu$ s) for Overvoltage Category III
Operational frequency range	45 to 65 Hz		
Leakage current @ rated voltage	< 3m AAC	Isolation Input to Output Input & Output to Case	3750 Vrms 2500 Vrms
Power factor	> 0.9 @ rated voltage		
Control input status	continuously ON Green LED, when control input is applied		

## Output Specifications

Rated operational current* AC-51 (IEC/EN 60947-4-3, UL508)	25 AAC	On state voltage drop	< 1.3 V
Minimum operational current	150 mA	$I^2t$ for fusing (t=10ms) minimum	525 A <sup>2</sup> s
Rep. overload current - UL508: T=40°C, tON=1s, tOFF=9s, 50 cycles	40 AAC	Critical dV/dt @ Tj init = 40°C	1000 V/us
Non-repetitive surge current (t=10ms)	325 Ap	Endurance testing acc. to UL508	100,000 cycles

\* Max. 25 AAC with suitable heatsink. Refer to Heatsink Selection tables.

## Output Voltage Specifications

Operational Voltage Range	24-280 VAC
Blocking voltage	600 Vp
Output protection	Integrated transil

## Input specifications

		RF1..L	RF1..M	RF1..D
Control voltage range	RF1A	4.25 - 9.0 VDC	9.0 - 18.0 VDC	18.0 - 28.8 VDC
	RF1B	4.5 - 9.0 VDC	11.0 - 18.0 VDC	18.0 - 28.8 VDC
Pick-up voltage	RF1A	4.25 VDC	9.0 VDC	18.0 VDC
	RF1B	4.5 VDC	11.0 VDC	18.0 VDC
Drop-out voltage		1.0 VDC	1.0 VDC	1.0 VDC
Maximum Reverse voltage		9.0 VDC	18.0 VDC	28.8 VDC
Max Response time pick-up	RF1A	1/2 cycle	1/2 cycle	1/2 cycle
	RF1B	350 $\mu$ s	350 $\mu$ s	350 $\mu$ s
Response time drop-out	RF1A	1/2 cycle	1/2 cycle	1/2 cycle
	RF1B	1/2 cycle	1/2 cycle	1/2 cycle
Input current		refer to diagrams below		

RF1..L

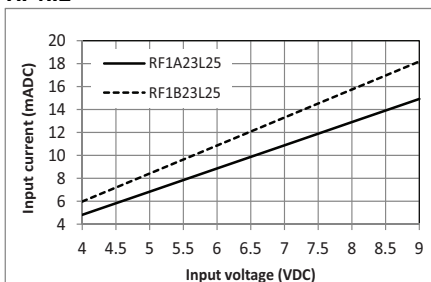

RF1..M

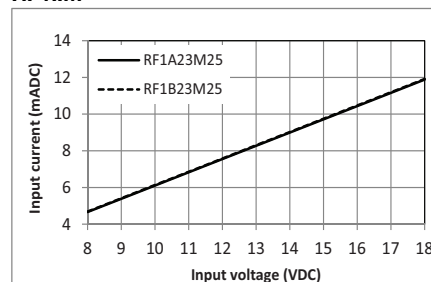

RF1..D

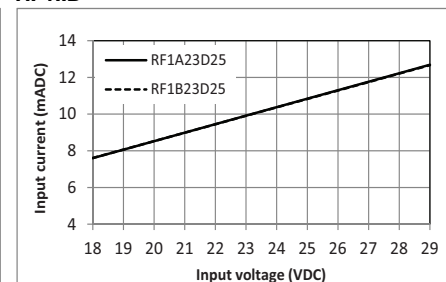

## Agency Approvals and Conformances

### Conformance

IEC/EN 62314  
IEC/EN 60947-4-3

### Agency Approvals

UR: UL508 Recognised, NRNT2 E80573  
cUR: CSA 22.2 No.14-10, NRNT8 E80573  
CSA: CSA 22.2 No.14-10, 204075  
VDE: DIN EN 60947-4-3 (VDE 0660-109)  
DIN EN 60335-1 (VDE 0700-1)



## Electromagnetic Compatibility

<b>EMC Immunity</b>	IEC/EN 60947-4-3
<b>Electrostatic Discharge (ESD) Immunity</b>	IEC/EN 61000-4-2
Air discharge, 8 kV	Performance Criteria 2
Contact, 4 kV	Performance Criteria 2
<b>Electrical Fast Transient (Burst) Immunity</b>	IEC/EN 61000-4-4
Output: 2 kV, 5kHz	Performance Criteria 2
Input: 1 kV, 5kHz	Performance Criteria 2
<b>Electrical Surge Immunity</b>	IEC/EN 61000-4-5
Output, line to line, 1 kV	Performance Criteria 1
Output, line to earth, 2 kV	Performance Criteria 1
Input, line to line, 500 V	Performance Criteria 1
Input, line to earth, 500 V	Performance Criteria 1

<b>EMC Emission</b>	IEC/EN 60947-4-3
<b>Radio Interference Voltage Emission (Conducted) 0.15 - 30MHz</b>	IEC/EN 55011
	Class A (for currents >15 AAC a filter 100 nF/ 275 VAC/ X1 is needed for compliance)

<b>Radiated Radio Frequency Immunity</b>	IEC/EN 61000-4-3
10V/m, 80 - 1000 MHz	Performance Criteria 1
10V/m, 1.4 - 2 GHz	Performance Criteria 1
3V/m, 2 - 2.7 GHz	Performance Criteria 1
<b>Conducted Radio Frequency Immunity</b>	IEC/EN 61000-4-6
10V/m, 0.15 - 80 MHz	Performance Criteria 1
<b>Voltage Dips Immunity</b>	IEC/EN 61000-4-11
0% for 0.5/1 cycle	Performance Criteria 2
40% for 10 cycles	Performance Criteria 2
70% for 250 cycles	Performance Criteria 2
<b>Voltage Interruptions Immunity</b>	IEC/EN 61000-4-11
0% for 5000 ms	Performance Criteria 2

<b>Radio Interference Field Emission (Radiated) 30 - 1000MHz</b>	IEC/EN 55011
	Class B

### Note:

- Performance Criteria 1: No degradation of performance or loss of function is allowed when the product is operated as intended.
- Performance Criteria 2: During the test, degradation of performance or partial loss of function is allowed. However when the test is complete the product should return operating as intended by itself.
- Performance Criteria 3: Temporary loss of function is allowed, provided the function can be restored by manual operation of the controls.
- Control input lines must be installed together to maintain products' susceptibility to Radio Frequency interference.
- Use of AC solid state relays may, according to the application and the load current, cause conducted radio interferences. Use of mains filters may be necessary for cases where the user must meet E.M.C requirements. The capacitor values given inside the filtering specification tables should be taken only as indications, the filter attenuation will depend on the final application.

## Filter Connection Diagram

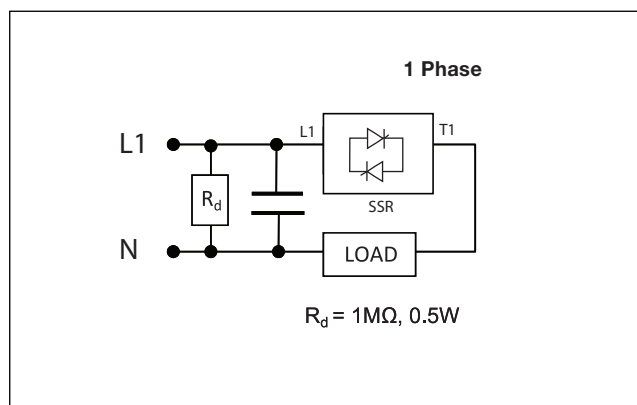



## Environmental and Housing Specifications

RoHS (2011/65/EU)	Compliant	Relative humidity	95% non-condensing @ 40°C
Pollution degree	2 (non-conductive pollution with possibilities of condensation)	UL flammability rating (housing)	UL 94 V0
Impact resistance (EN50155, EN61373)	15/11 g/ms	Installation altitude	0-1000 m. Above 1000 m derate linearly by 1% of FLC per 100 m up to a maximum of 2000 m
Vibration resistance (2-100Hz, IEC60068-2-6, EN50155, EN61373)	2 g	GWIT & GWFI	conforms to EN 60335-1 requirements
Weight	approx. 15 g approx. 210 g (box of 10 pcs.)		
Material	PA66, RAL7035		

## Terminal Layout and Dimensions

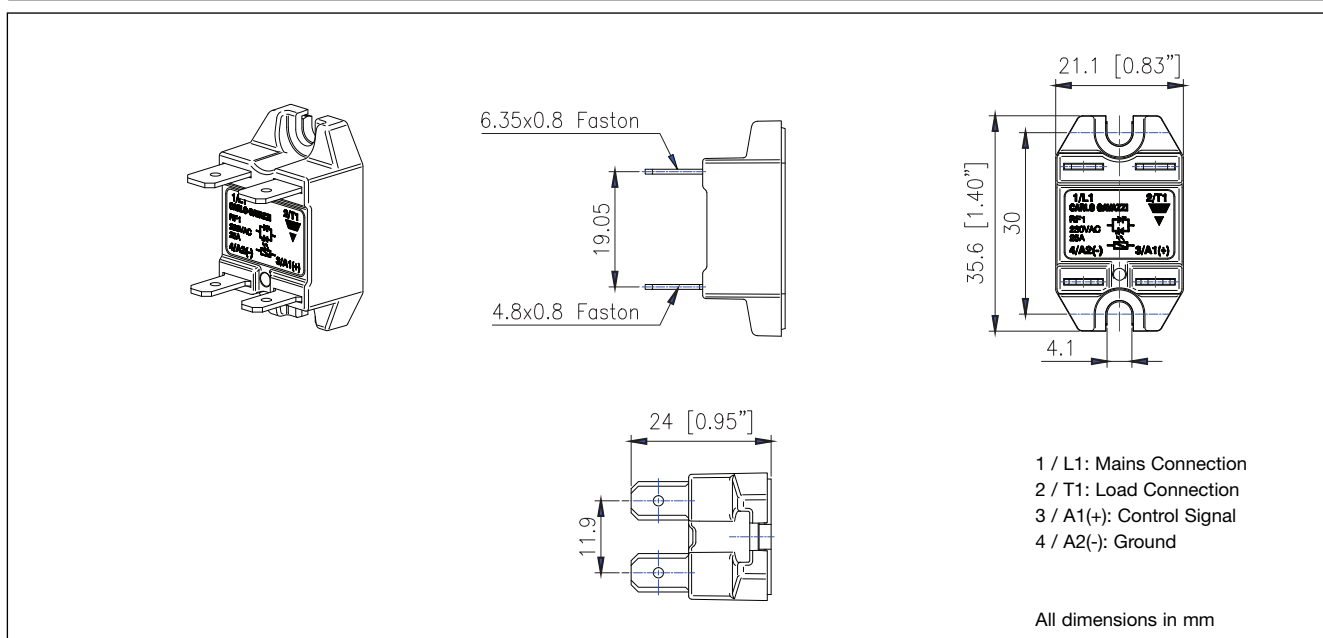

## Connection Specifications

SSR mounting screws	M4
Terminal material	CuEtp, Nickel plated copper
Mounting torque	1.0Nm (8.85lb-in)
Fastons pull out force*	130N
Connection type power: 1/L1, 2/T1	Faston 6.35 x 0.8mm
Connection type control: 3/A1+, 4/A2-	Faston 4.8 x 0.8mm

\*Refer to Installation instructions

## Functional Diagram

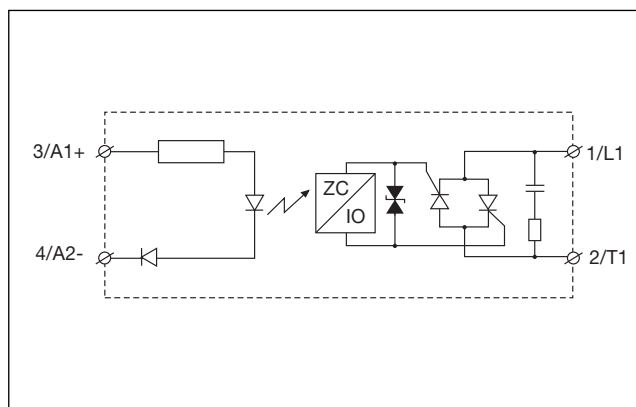

## Heatsink Selection

	Load current [A]							Power dissipation [W]
	2.5	5	7.5	10	12.5	15	17.5	
25	2.5	1.9	1.3	0.8	0.3	--	--	23.8
22.5	3.2	2.5	1.8	1.1	0.5	--	--	20.9
20	4.1	3.2	2.4	1.6	0.9	0.2	--	18.1
17.5	5.5	4.3	3.2	2.3	1.4	0.6	--	15.4
15	7.5	5.9	4.4	3.2	2.1	1.0	0.1	12.9
12.5	10	8.4	6.4	4.6	3.1	1.7	0.5	10.4
10	16	12	9.3	6.8	4.7	2.8	1.2	8.1
7.5	--	--	15	10	7.1	4.3	2.0	5.9
5	--	--	--	--	13	7.5	3.4	3.8
2.5	--	--	--	--	--	--	--	1.9
	20	30	40	50	60	70	80	T <sub>A</sub>

Note: These thermal resistance values are only applicable to the RF1 using the pre-attached thermal interface.

## Connection Diagram

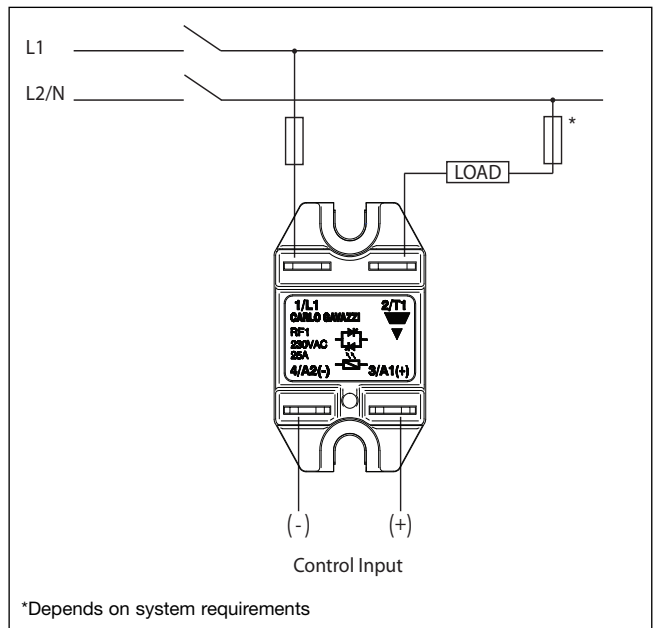

## Output Power Dissipation (P<sub>D</sub>)

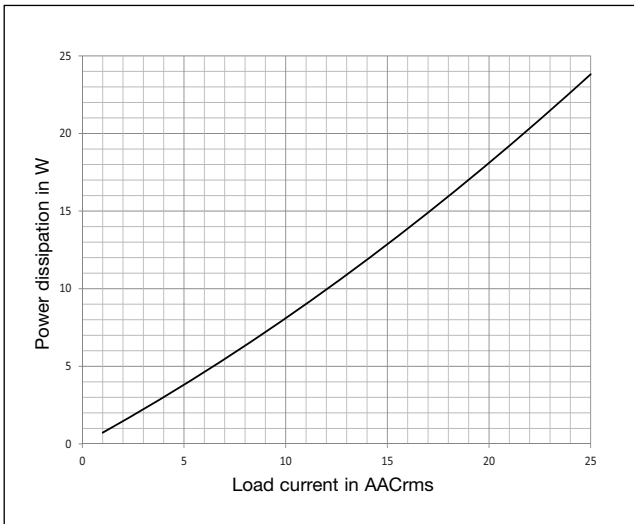

## Thermal Specifications

Operating temperature	-30 °C to 80 °C (-22 to 176 °F)
Storage temperature	-40 °C to 100 °C (-40 to 212 °F)
Max. junction temperature, T <sub>j</sub>	100 °C (212 °F)
Junction to heatsink thermal resistance, including pre-attached thermal interface, R <sub>thjc</sub>	1.5 °C/W
Max. case temperature, T <sub>c</sub>	T <sub>j</sub> - (P <sub>D</sub> x R <sub>thjc</sub> ) See chart below

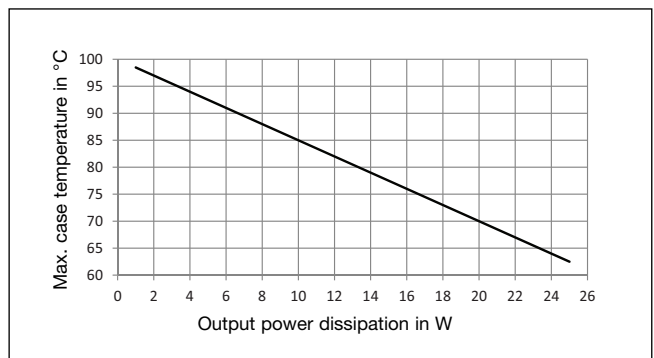

Duty cycle is considered to be 100%

## Short Circuit Protection, Co-ordination Type 2

Part No.	Prospective short circuit current [kArms]	Mersen*	Siba
RF1..25	10	690 VAC, 25A gR 10x38 mm, FR10GR69V25	600 VAC, 25A gRL 10x38 mm, 60 034 34.25

\* formerly Ferraz Shawmut

## Installation

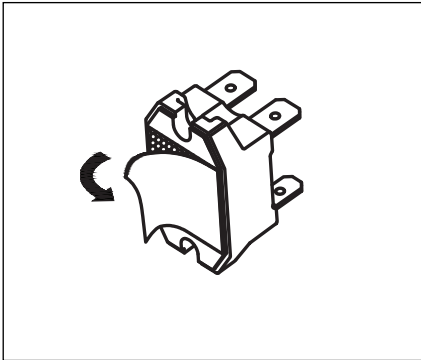

1. Peel off liner before mounting on heatsink.

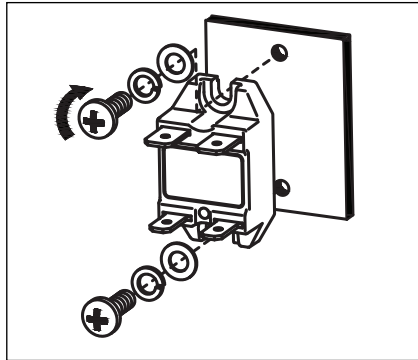

2. Tighten screws alternately to max. 1.0Nm.

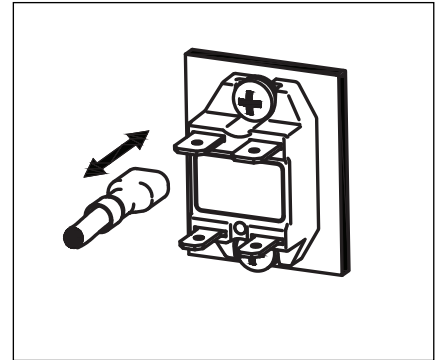

3. Insert / remove FASTON receptacle only with RF1 tightened to a surface.

## Packaging



- 10 pcs. per box
- Weight per box, approx. 210 g

## Accessories

### Phase Change Thermal Pad

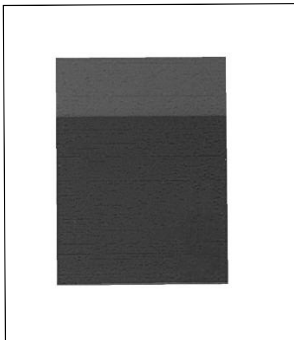

#### Ordering Key **RFHT**

- Phase change thermal pad for RF1
- Dimensions: 19mm x 17mm
- Packing quantity: 10 pieces

### Heatsinks

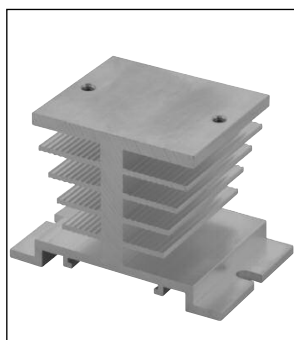

#### Ordering Key **RHS5050RFD**

- 3.5°C/W thermal resistance
- Dimensions: 80 x 50 x 51mm  
(Max. rating with mounted RF1 @ 40°C is 15 AAC)
- Panel Mounting

#### Ordering Key **RHS38ARFD**

- 2.85°C/W thermal resistance
- Dimensions: 46 x 76 x 33mm  
(Max. rating with mounted RF1 @ 40°C is 16 AAC)
- Thru wall or Panel Mounting

For specific details refer to the individual datasheet of each heatsink model.