



Chipsmall Limited consists of a professional team with an average of over 10 year of expertise in the distribution of electronic components. Based in Hongkong, we have already established firm and mutual-benefit business relationships with customers from,Europe,America and south Asia,supplying obsolete and hard-to-find components to meet their specific needs.

With the principle of “Quality Parts,Customers Priority,Honest Operation,and Considerate Service”,our business mainly focus on the distribution of electronic components. Line cards we deal with include Microchip,ALPS,ROHM,Xilinx,Pulse,ON,Everlight and Freescale. Main products comprise IC,Modules,Potentiometer,IC Socket,Relay,Connector.Our parts cover such applications as commercial,industrial, and automotives areas.

We are looking forward to setting up business relationship with you and hope to provide you with the best service and solution. Let us make a better world for our industry!



## Contact us

Tel: +86-755-8981 8866 Fax: +86-755-8427 6832

Email & Skype: info@chipsmall.com Web: www.chipsmall.com

Address: A1208, Overseas Decoration Building, #122 Zhenhua RD., Futian, Shenzhen, China



**Typical Applications**

- Broadband, Low Noise Gain Blocks
- IF or RF Buffer Amplifiers
- Driver Stage for Power Amplifiers
- Final PA for Low Power Applications
- Broadband Test Equipment

**Product Description**

The RF2334 is a general purpose, low-cost RF amplifier IC. The device is manufactured on an advanced Gallium Arsenide Heterojunction Bipolar Transistor (HBT) process, and has been designed for use as an easily-cascadable 50Ω gain block. Applications include IF and RF amplification in wireless voice and data communication products operating in frequency bands up to 4000MHz. The device is self-contained with 50Ω input and output impedances and requires only two external DC biasing elements to operate as specified. The RF2334 is available in a very small industry-standard SOT23-5 surface mount package, enabling compact designs which conserve board space.

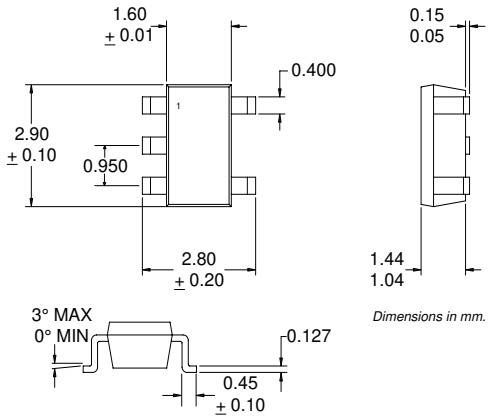

**Optimum Technology Matching® Applied**

- |                                     |  |                                       |
|-------------------------------------|--|---------------------------------------|
| <input type="checkbox"/> Si BJT     | <input checked="" type="checkbox"/> GaAs HBT | <input type="checkbox"/> GaAs MESFET  |
| <input type="checkbox"/> Si Bi-CMOS | <input type="checkbox"/> SiGe HBT            | <input type="checkbox"/> Si CMOS      |
| <input type="checkbox"/> InGaP/HBT  | <input type="checkbox"/> GaN HEMT            | <input type="checkbox"/> SiGe Bi-CMOS |

**Package Style: SOT23-5**

**Features**

- DC to 6000MHz Operation
- Internally matched Input and Output
- 16dB Small Signal Gain
- 5dB Noise Figure
- +18.5dBm Output Power
- Single Positive Power Supply

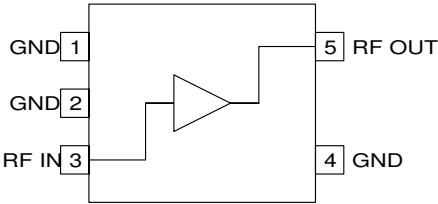

**Functional Block Diagram**

**Ordering Information**

- |             |                                  |
|-------------|----------------------------------|
| RF2334      | General Purpose Amplifier        |
| RF2334 PCBA | Fully Assembled Evaluation Board |

RF Micro Devices, Inc.  
7628 Thorndike Road  
Greensboro, NC 27409, USA

Tel (336) 664 1233  
Fax (336) 664 0454  
<http://www.rfmd.com>

# RF2334

## Absolute Maximum Ratings

Parameter	Rating	Unit
Input RF Power	+13	dBm
Operating Ambient Temperature	-40 to +85	°C
Storage Temperature	-60 to +150	°C



**Caution!** ESD sensitive device.

RF Micro Devices believes the furnished information is correct and accurate at the time of this printing. However, RF Micro Devices reserves the right to make changes to its products without notice. RF Micro Devices does not assume responsibility for the use of the described product(s).

Parameter	Specification			Unit	Condition
	Min.	Typ.	Max.		
<b>Overall</b>					T=25°C, I <sub>CC</sub> =65mA
Frequency Range		DC to 6000		MHz	
3dB Bandwidth		2.5		GHz	
Gain		19.4		dB	Freq=100MHz
		18		dB	Freq=1000MHz
		16		dB	Freq=2000MHz
		14		dB	Freq=3000MHz
		13		dB	Freq=4000MHz
Gain Flatness		±2		dB	100MHz to 2000MHz
Noise Figure		4.8		dB	Freq=2000MHz
Input VSWR		2.1:1			In a 50Ω system, DC to 4000MHz
Output VSWR		1.8:1			In a 50Ω system, DC to 4000MHz
Output IP <sub>3</sub>		+33		dBm	Freq=1000MHz±50kHz, P <sub>TONE</sub> =-10dBm
Output P <sub>1dB</sub>		+18.5		dBm	Freq=1000MHz
Reverse Isolation		20.5		dB	Freq=2000MHz
<b>Thermal</b>					I <sub>CC</sub> =65mA, P <sub>DISS</sub> =300mW (See Note.)
Theta <sub>JC</sub>		288		°C/W	
Maximum Measured Junction Temperature		172		°C	T <sub>AMB</sub> =+85°C, V <sub>PIN</sub> =4.64V
Mean Time Between Failures		400		years	See Note.
<b>Power Supply</b>					With 22Ω bias resistor
Device Operating Voltage		4.8		V	At pin 5 with I <sub>CC</sub> =65mA
Supply Voltage		6.3		V	At evaluation board connector, I <sub>CC</sub> =65mA
Operating Current		65	68	mA	See note.

Note: Because of process variations from part to part, the current resulting from a fixed bias voltage will vary. As a result, caution should be used in designing fixed voltage bias circuits to ensure the worst case bias current does not exceed 68mA over all intended operating conditions.

Pin	Function	Description	Interface Schematic
1	<b>GND</b>	Ground connection. For best performance, keep traces physically short and connect immediately to ground plane.	
2	<b>GND</b>	Same as pin 1.	
3	<b>RF IN</b>	RF input pin. This pin is NOT internally DC-blocked. A DC-blocking capacitor, suitable for the frequency of operation, should be used in most applications. DC coupling of the input is not allowed, because this will override the internal feedback loop and cause temperature instability.	
4	<b>GND</b>	Same as pin 1.	
5	<b>RF OUT</b>	RF output and bias pin. Biasing is accomplished with an external series resistor and choke inductor to $V_{CC}$ . The resistor is selected to set the DC current into this pin to a desired level. The resistor value is determined by the following equation:  $R = \frac{(V_{SUPPLY} - V_{DEVICE})}{I_{CC}}$ <p>Care should also be taken in the resistor selection to <b>ensure that the current into the part never exceeds 68mA over the planned operating temperature</b>. This means that a resistor between the supply and this pin is always required, even if a supply near 4.8V is available, to provide DC feedback to prevent thermal runaway. Because DC is present on this pin, a DC blocking capacitor, suitable for the frequency of operation, should be used in most applications. The supply side of the bias network should also be well bypassed.</p>	

## Evaluation Board Schematic

(Download [Bill of Materials](http://www.rfmd.com) from [www.rfmd.com](http://www.rfmd.com).)

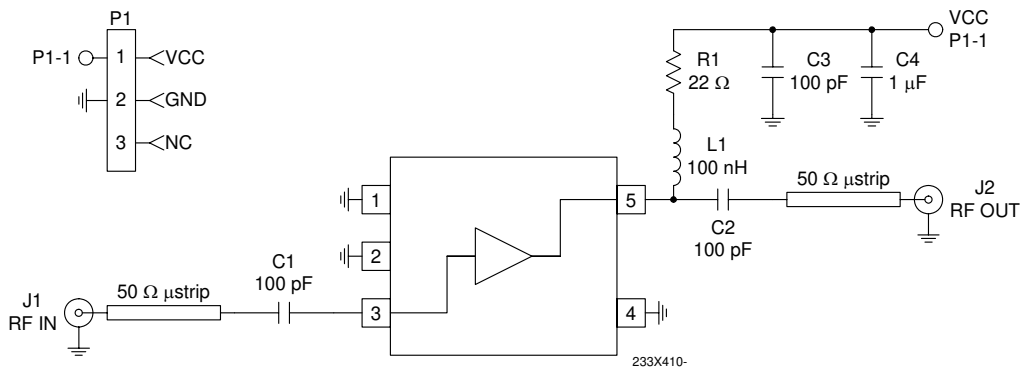

# RF2334

## Evaluation Board Layout Board Size 1.0" x 1.0"

Board Thickness 0.020", Board Material R0-4003 Rogers

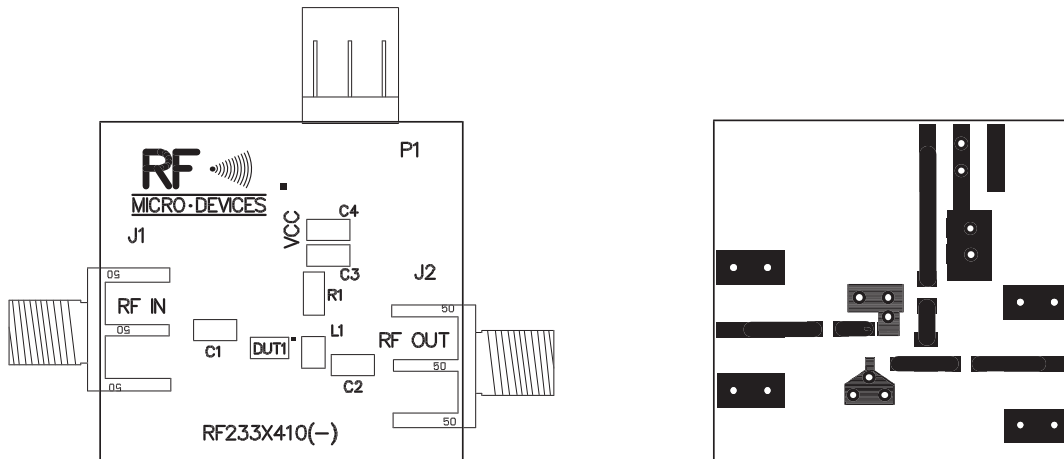

**Gain versus Frequency Across Temperature**

$I_{CC} = 65 \text{ mA}$

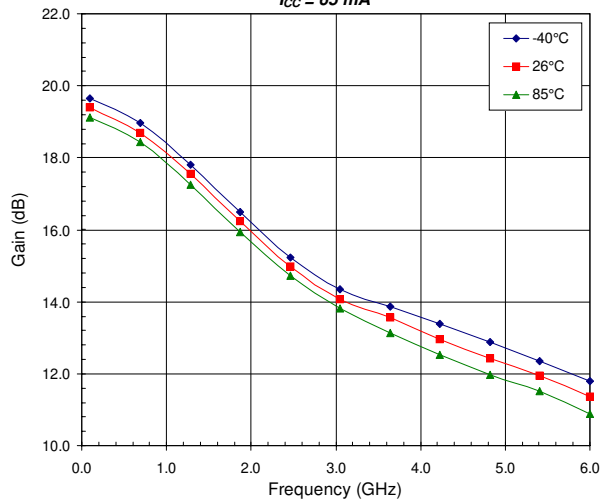

**Output P1dB versus Frequency Across Temperature**

$I_{CC} = 65 \text{ mA}$

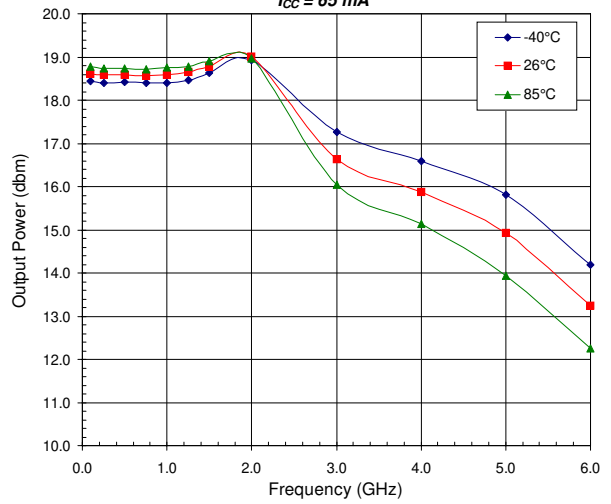

**Output IP3 versus Frequency Across Temperature**

$I_{CC} = 65 \text{ mA}$

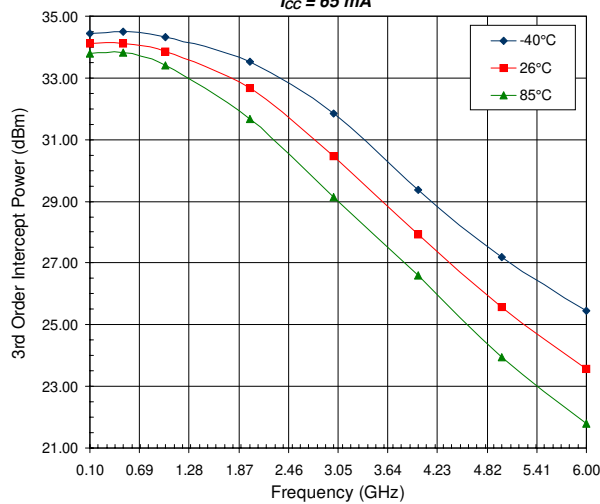

**Noise Figure versus Frequency Across Temperature**

$I_{CC} = 65 \text{ mA}$

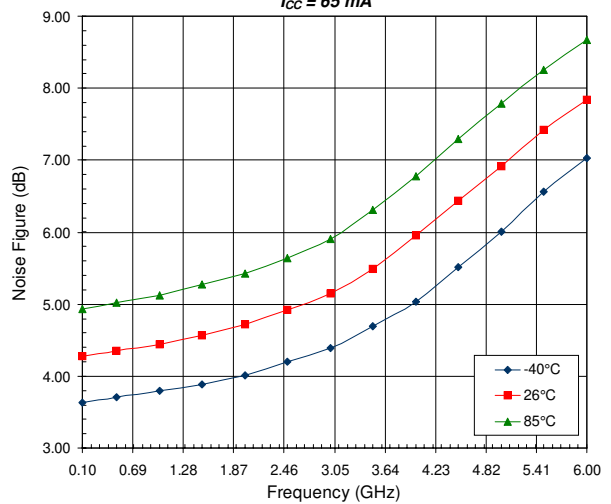

**Input VSWR versus Frequency Across Temperature**

$I_{CC} = 65 \text{ mA}$

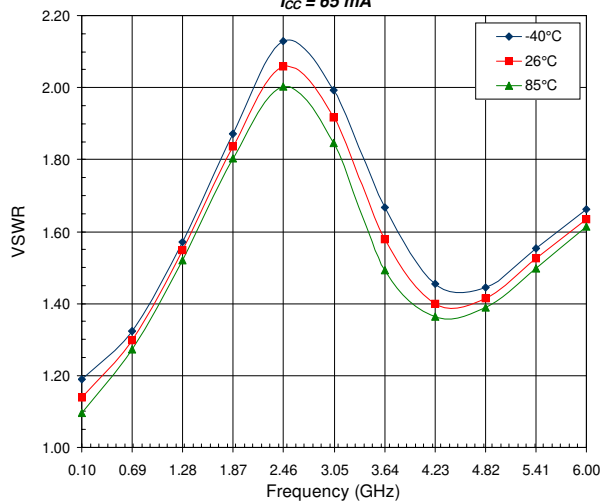

**Output VSWR versus Frequency Across Temperature**

$I_{CC} = 65 \text{ mA}$

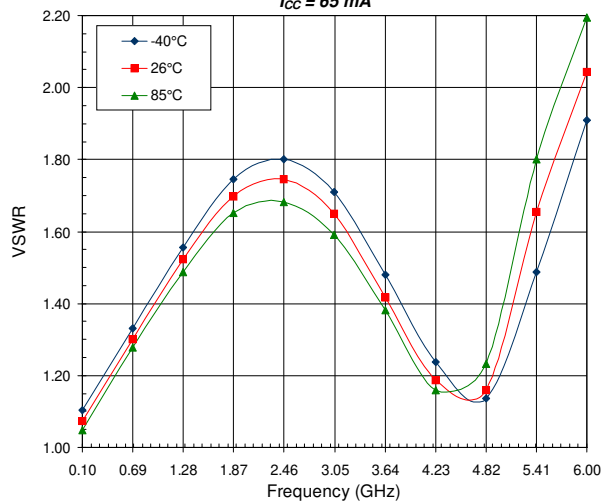

# RF2334

**Reverse Isolation versus Frequency Across Temperature,  $I_{CC} = 65 \text{ mA}$**

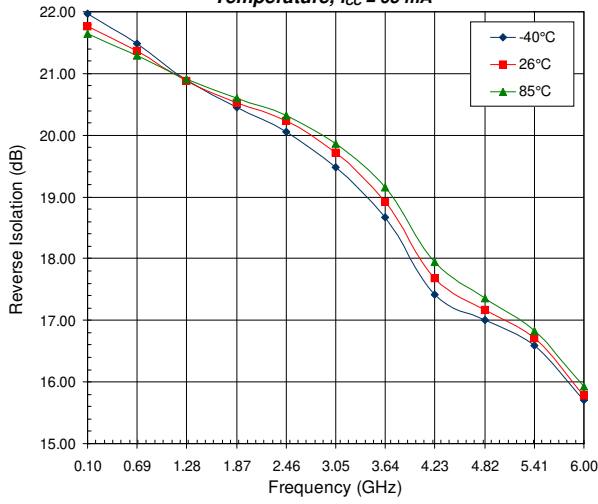

**Current versus Voltage at Evaluation Board Connector,  $R_{BIAS} = 22 \Omega$**

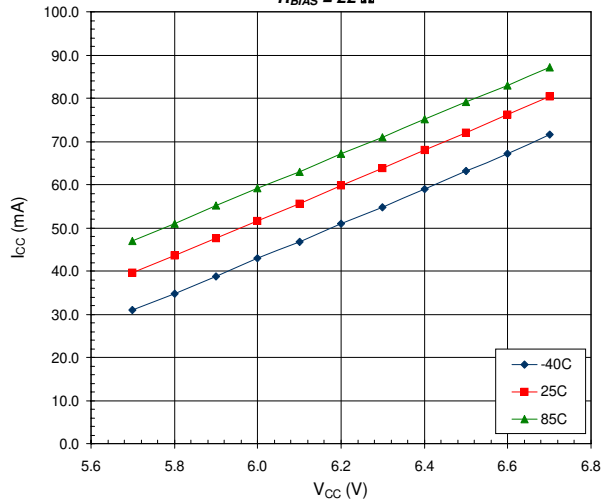

**Current versus Voltage (At Pin 5)**

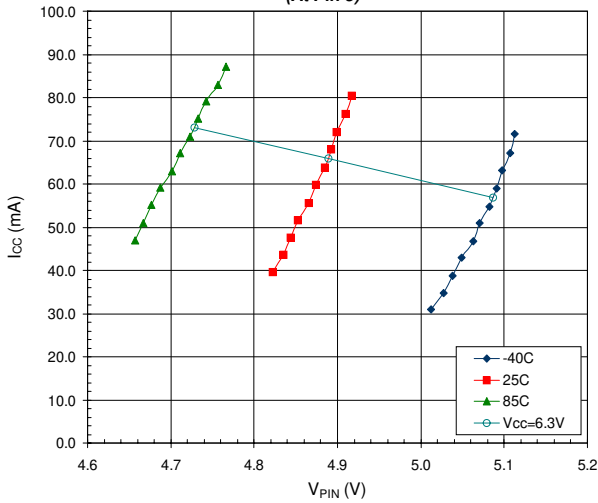

**Power Dissipated versus Voltage at Pin 5 ( $T_{AMBIENT} = +85^\circ\text{C}$ )**

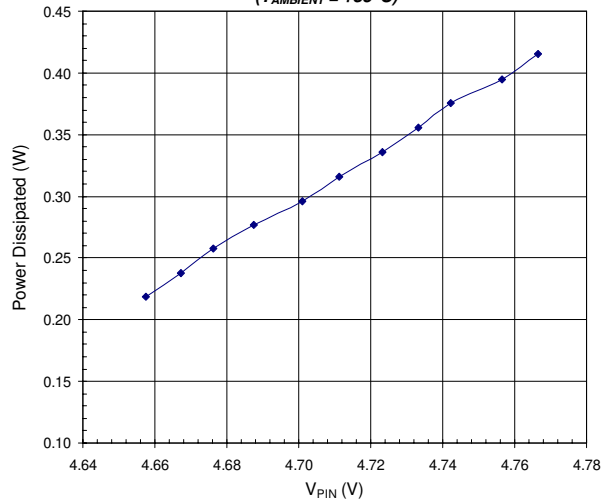

**Junction Temperature versus Power Dissipated ( $T_{AMBIENT} = +85^\circ\text{C}$ )**

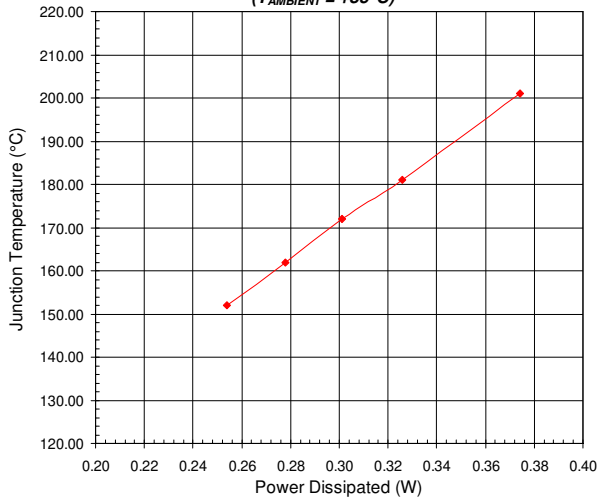

**MTTF versus Junction Temperature (60% Confidence Interval)**

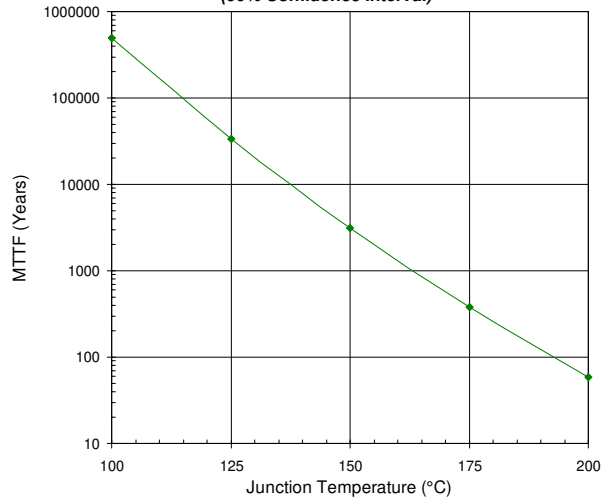

**De-Embedded S11,  $V_{CC} = 4.84V$ ,  $I_{CC} = 65mA$ ,  $T = 25^{\circ}C$**

Swp Max  
6GHz

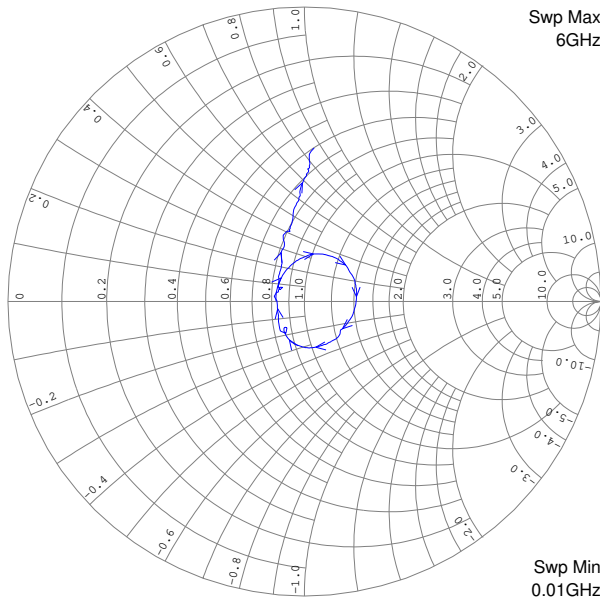

Swp Min  
0.01GHz

**De-Embedded S22,  $V_{CC} = 4.84V$ ,  $I_{CC} = 65mA$ ,  $T = 25^{\circ}C$**

Swp Max  
6GHz

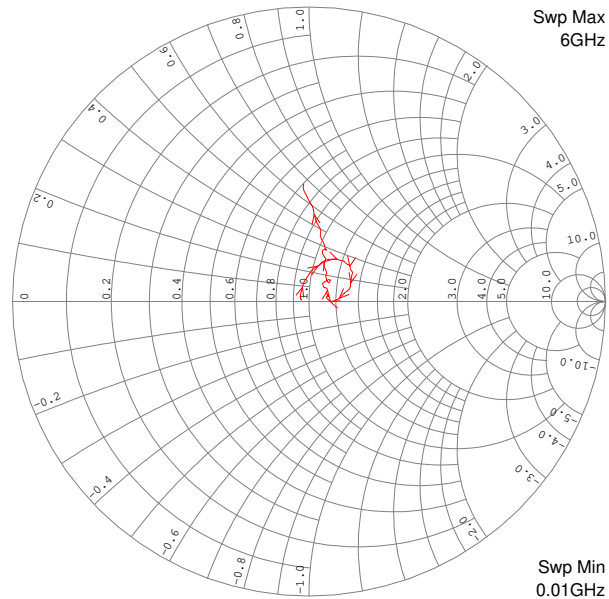

Swp Min  
0.01GHz



***RF2334***