



Chipsmall Limited consists of a professional team with an average of over 10 year of expertise in the distribution of electronic components. Based in Hongkong, we have already established firm and mutual-benefit business relationships with customers from,Europe,America and south Asia,supplying obsolete and hard-to-find components to meet their specific needs.

With the principle of “Quality Parts,Customers Priority,Honest Operation,and Considerate Service”,our business mainly focus on the distribution of electronic components. Line cards we deal with include Microchip,ALPS,ROHM,Xilinx,Pulse,ON,Everlight and Freescale. Main products comprise IC,Modules,Potentiometer,IC Socket,Relay,Connector.Our parts cover such applications as commercial,industrial, and automotives areas.

We are looking forward to setting up business relationship with you and hope to provide you with the best service and solution. Let us make a better world for our industry!



Contact us

Tel: +86-755-8981 8866 Fax: +86-755-8427 6832

Email & Skype: info@chipsmall.com Web: www.chipsmall.com

Address: A1208, Overseas Decoration Building, #122 Zhenhua RD., Futian, Shenzhen, China



Package: Hermetic 2-Pin, Flanged Ceramic



Features

- Wideband Operation 2.8GHz to 3.4GHz
- Advanced GaN HEMT Technology
- Advanced Heat-Sink Technology
- Optimized Evaluation Board Layout for 50Ω Operation
- Integrated Matching Components for High Terminal Impedances
- 65V Operation Typical Performance
 - Pulsed Output Power 380W
 - Small Signal Gain 13dB
 - Drain Efficiency 50%
 - -40 °C to 85 °C Operating Temperature

Applications

- Radar
- Air Traffic Control and Surveillance
- General Purpose Broadband Amplifiers

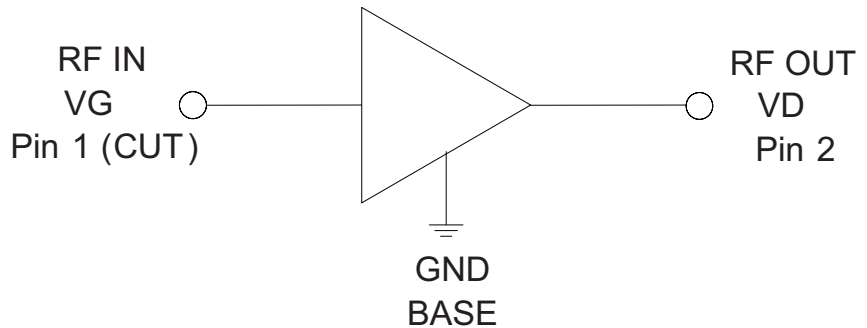

Functional Block Diagram

Product Description

The RF3928B is a 65V 380W high power discrete amplifier designed for S-Band pulsed radar, Air Traffic Control and Surveillance, and general purpose broadband amplifier applications. Using an advanced high power density Gallium Nitride (GaN) semiconductor process, these high-performance amplifiers achieve high output power, high efficiency and flat gain over a broad frequency range in a single package. The RF3928B is a matched GaN transistor packaged in a hermetic, flanged ceramic package. This package provides excellent thermal stability through the use of advanced heat sink and power dissipation technologies. Ease of integration is accomplished through the incorporation of simple, optimized matching networks external to the package that provide wideband gain and power performance in a single amplifier.

Ordering Information

RF3928B 380W GaN Wideband Pulsed Power Amplifier
 RF3928BPCBA-410 Fully Assembled Evaluation Board Optimized for 2.8GHz to 3.4GHz; 65V

Optimum Technology Matching® Applied

- | | | | |
|--------------------------------------|--------------------------------------|-------------------------------------|--|
| <input type="checkbox"/> GaAs HBT | <input type="checkbox"/> SiGe BiCMOS | <input type="checkbox"/> GaAs pHEMT | <input checked="" type="checkbox"/> GaN HEMT |
| <input type="checkbox"/> GaAs MESFET | <input type="checkbox"/> Si BiCMOS | <input type="checkbox"/> Si CMOS | <input type="checkbox"/> BiFET HBT |
| <input type="checkbox"/> InGaP HBT | <input type="checkbox"/> SiGe HBT | <input type="checkbox"/> Si BJT | <input type="checkbox"/> LD MOS |

RF MICRO DEVICES®, RFMD®, Optimum Technology Matching®, Enabling Wireless Connectivity™, PowerStar®, POLARIS™ TOTAL RADIO™ and UltimateBlue™ are trademarks of RFMD, LLC. BLUETOOTH is a trademark owned by Bluetooth SIG, Inc., U.S.A. and licensed for use by RFMD. All other trade names, trademarks and registered trademarks are the property of their respective owners. ©2011, RF Micro Devices, Inc.

Absolute Maximum Ratings

Parameter	Rating	Unit
Drain Source Voltage	150	V
Gate Source Voltage	-8 to +2	V
Gate Current (I_G)	155	mA
Operational Voltage	65	V
Ruggedness (VSWR)	3:1	
Storage Temperature Range	-55 to +125	°C
Operating Temperature Range (T_L)	-40 to +85	°C
Operating Junction Temperature (T_J)	200	°C
Human Body Model	Class 1A	
MTTF ($T_J < 200$ °C)	3.0E + 06	Hours
Thermal Resistance, Rth (junction to case)		
$T_C = 85$ °C, DC bias only	0.90	°C/W
$T_C = 85$ °C, 100ms pulse, 10% duty cycle	0.30	



Caution! ESD sensitive device.

Exceeding any one or a combination of the Absolute Maximum Rating conditions may cause permanent damage to the device. Extended application of Absolute Maximum Rating conditions to the device may reduce device reliability. Specified typical performance or functional operation of the device under Absolute Maximum Rating conditions is not implied.

The information in this publication is believed to be accurate and reliable. However, no responsibility is assumed by RF Micro Devices, Inc. ("RFMD") for its use, nor for any infringement of patents, or other rights of third parties, resulting from its use. No license is granted by implication or otherwise under any patent or patent rights of RFMD. RFMD reserves the right to change component circuitry, recommended application circuitry and specifications at any time without prior notice.



RoHS (Restriction of Hazardous Substances): Compliant per EU Directive 2002/95/EC.

* MTTF – median time to failure for wear-out failure mode (30% I_{dss} degradation) which is determined by the technology process reliability. Refer to product qualification report for FIT (random) failure rate.

Operation of this device beyond any one of these limits may cause permanent damage. For reliable continuous operation, the device voltage and current must not exceed the maximum operating values specified in the table on page two.

Bias Conditions should also satisfy the following expression: $P_{DISS} < (T_J - T_C) / R_{TH}$ J-C and $T_C = T_{CASE}$

Parameter	Specification			Unit	Condition
	Min.	Typ.	Max.		
Recommended Operating Condition					
Drain Voltage (V_{DSQ})			65	V	
Gate Voltage (V_{GSQ})	-8	-3	-2	V	
Drain Bias Current		440		mA	
Frequency of Operation	2800		3400	MHz	
DC Functional Test					
$I_{G(OFF)}$ – Gate Leakage			2	mA	$V_G = -8V, V_D = 0V$
$I_{D(OFF)}$ – Drain Leakage			2	mA	$V_G = -8V, V_D = 65V$
$V_{GS(th)}$ – Threshold Voltage		-3.5		V	$V_D = 65V, I_D = 40mA$
$V_{DS(on)}$ – Drain Voltage at high current		0.22		V	$V_G = 0V, I_D = 1.5A$
RF Functional Test					
Small Signal Gain		13		dB	F = 2900MHz, Pin = 30dBm
Power Gain	11.2	11.8		dB	F = 2900MHz, Pin = 44dBm
Input Return Loss			-6	dB	F = 2900MHz, Pin = 30dBm
Output Power	55.2	55.8		dBm	F = 2900MHz, Pin = 44dBm
Drain Efficiency	45	50		%	

Parameter	Specification			Unit	Condition
	Min.	Typ.	Max.		
Small Signal Gain		13		dB	F=3150MHz, Pin=30dBm
Power Gain	11.2	11.8		dB	F=3150MHz, Pin=44dBm
Input Return Loss			-6	dB	F=3150MHz, Pin=30dBm
Output Power	55.2	55.8		dBm	F=3150MHz, Pin=44dBm
Drain Efficiency	45	50		%	
Small Signal Gain		13		dB	F=3400MHz, Pin=30dBm
Power Gain	11.3	11.8		dB	F=3400MHz, Pin=44dBm
Input Return Loss			-6	dB	F=3400MHz, Pin=30dBm
Output Power	55.3	55.8		dBm	F=3400MHz, Pin=44dBm
Drain Efficiency	45	50		%	
RF Typical Performance					[1, 2]
Frequency Range	2800		3400	MHz	
Small Signal Gain		13		dB	F=3100MHz, Pin=30dBm
Power Gain		11.8		dB	P _{OUT} =55.8dBm
Gain Variation with Temperature			-0.015	dB/°C	At peak output power
Output Power (P _{SAT})		55.8		dBm	Peak output power
		380		W	Peak output power
Drain Efficiency		50		%	At peak output power

[1] Test Conditions: Pulsed Operation, PW=100μsec, DC=10%, V_{DS}=65V, I_{DQ}=440mA, T=25°C

[2] Performance in a standard tuned test fixture

Typical Performance in Standard Fixed Tuned Test Fixture over Temperature (Pulsed at Center Band Frequency)

Gain versus Output Power (f = 3200MHz)
(Pulsed 10% duty cycle, 100μs, V_D = 65V, I_{DQ} = 440mA)

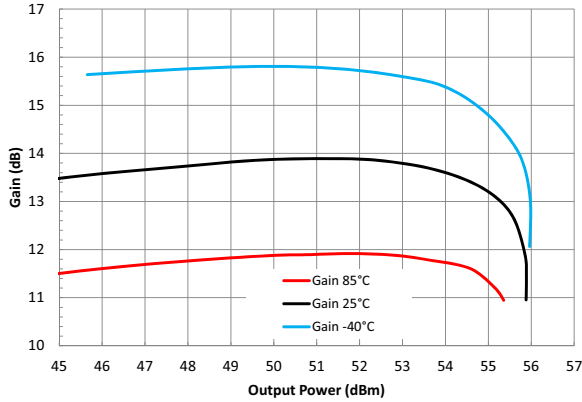

Efficiency versus Output Power (f = 3200MHz)
(Pulsed 10% duty cycle, 100μs, V_D = 65V, I_{DQ} = 440mA)

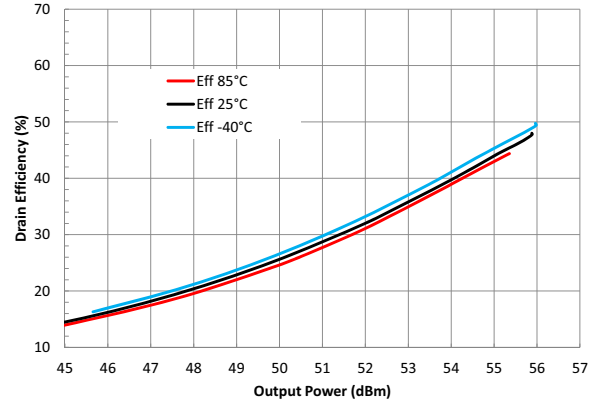

Input Return Loss versus Output Power (f = 3200MHz)
(Pulsed 10% duty cycle, 100μs, V_D = 65V, I_{DQ} = 440mA)

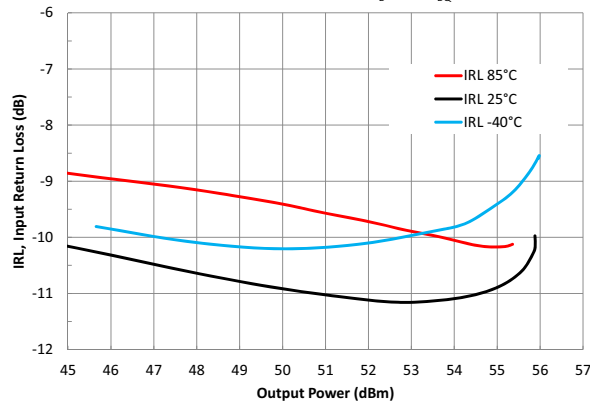

Typical Performance in Standard Fixed-tuned Test Fixture (T=25 °C, Unless Noted)

Small Signal Performance versus Frequency, $P_{IN} = 30\text{dBm}$
(Pulsed 10% duty cycle, $100\mu\text{s}$, $V_D = 65\text{V}$, $I_{DQ} = 440\text{mA}$)

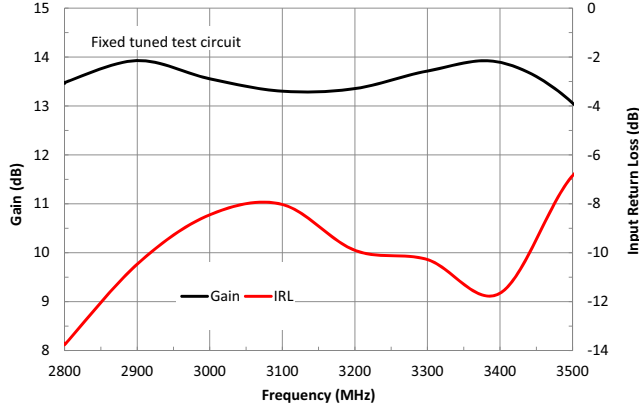

Gain/IRL versus Frequency, $P_{IN} = 44\text{dBm}$
(Pulsed 10% duty cycle, $100\mu\text{s}$, $V_D = 65\text{V}$, $I_{DQ} = 440\text{mA}$)

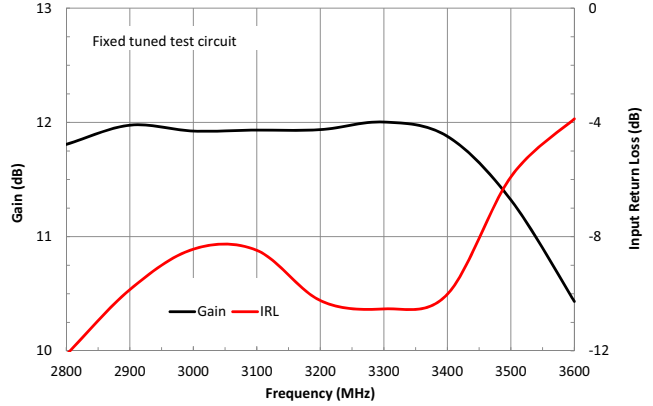

Drain Efficiency versus Frequency, $P_{IN} = 44\text{dBm}$
(Pulsed 10% duty cycle, $100\mu\text{s}$, $V_D = 65\text{V}$, $I_{DQ} = 440\text{mA}$)

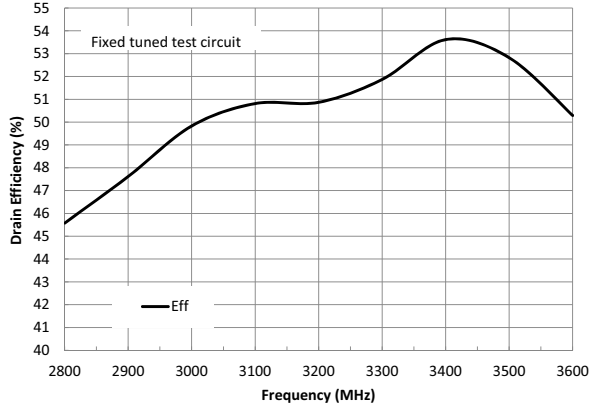

Gain/ Efficiency versus P_{OUT} , $f = 3200\text{MHz}$
(Pulsed 10% duty cycle, $100\mu\text{s}$, $V_D = 65\text{V}$, $I_{DQ} = 440\text{mA}$)

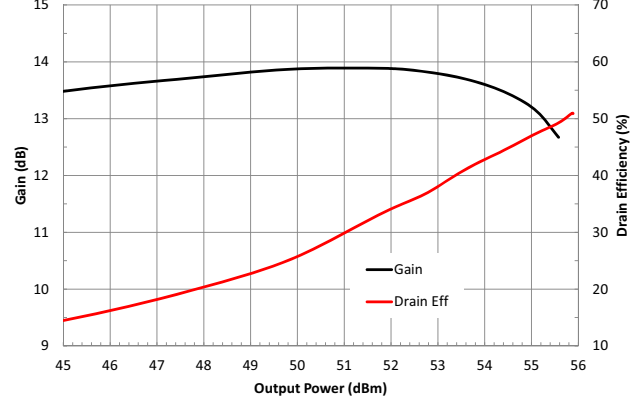

Typical Performance in Standard Fixed-tuned Test Fixture (T=25 °C, Unless Noted)

Pout/DE versus Pulse Width, f = 3200MHz
(Pulsed 10% duty cycle, $V_D = 65V$, $I_{DQ} = 440mA$)

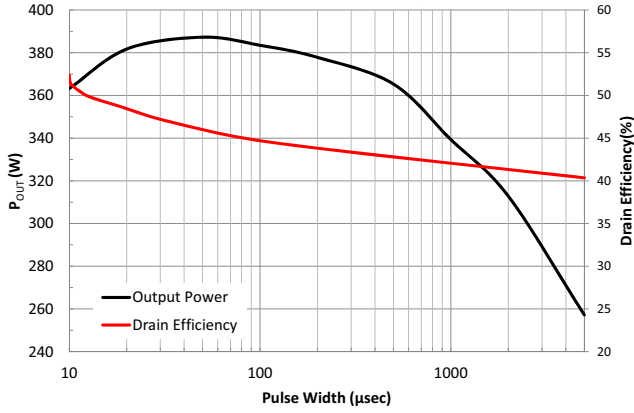

Pout/DE versus Duty Cycle, f = 3200MHz
(Pulsed ,100µs pulse, $V_D = 65V$, $I_{DQ} = 440mA$)

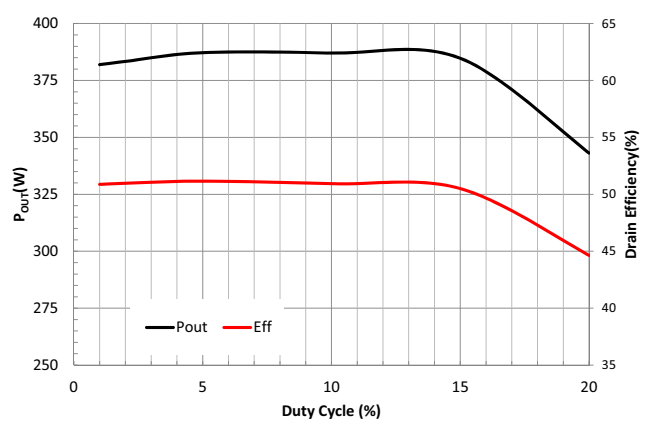

CW Power Dissipation De-rating Curve
(Based on Maximum package temperature and R_{TH})

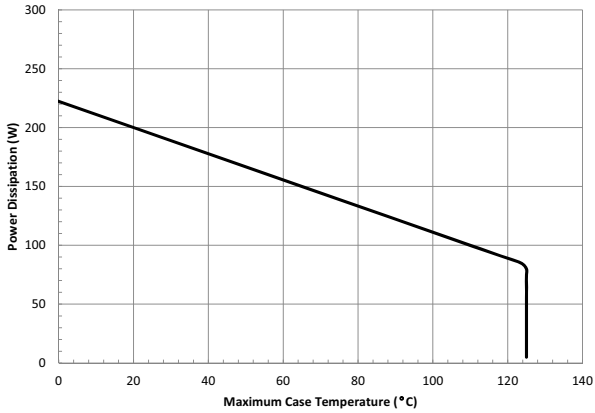

Pulse Power Dissipation De-rating Curve
(Based on Maximum package temperature and R_{TH})

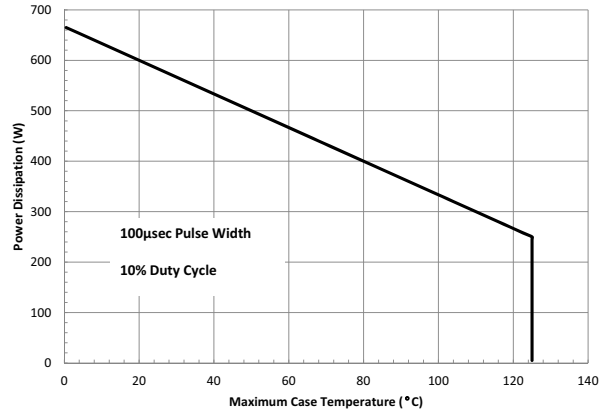

**Package Drawing
(All Dimensions in mm)**

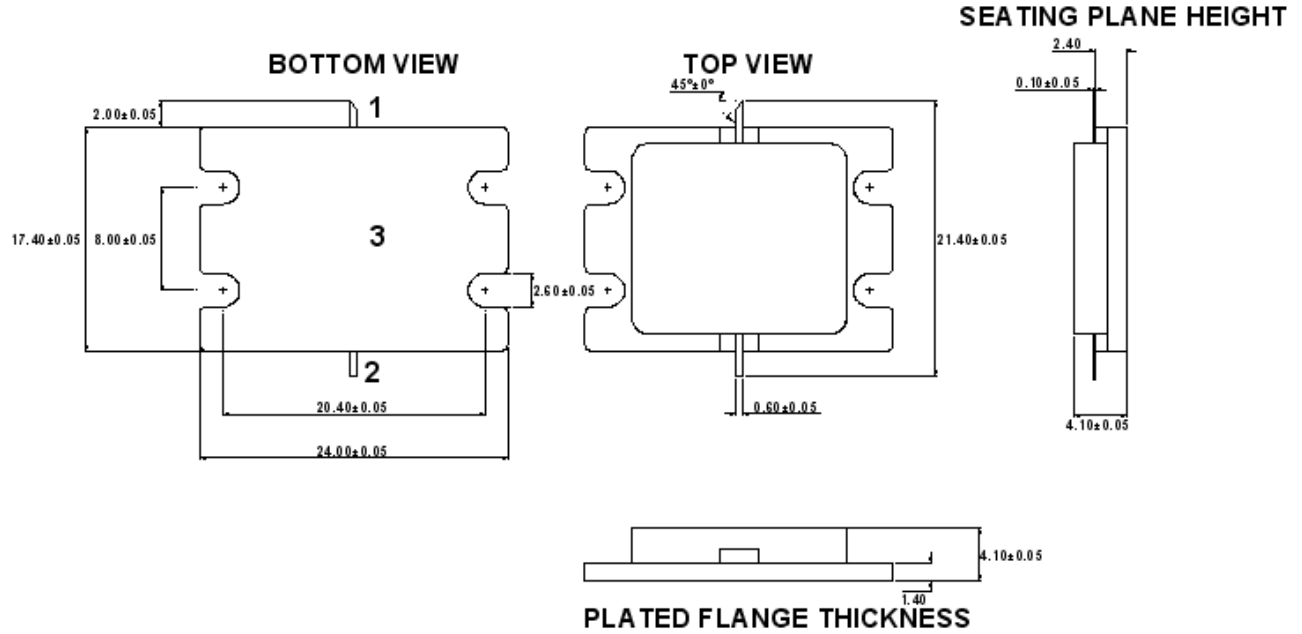

Pin	Function	Description
1	Gate	V_G RF Input
2	Drain	V_D RF Output
3	Source	Ground Base

Bias Instruction for RF3928B Evaluation Board

ESD Sensitive Material. Please use proper ESD precautions when handling devices of evaluation board. Evaluation board requires additional external fan cooling. Connect all supplies before powering evaluation board.

1. Connect RF cables at RFIN and RFOUT.
2. Connect ground to the ground supply terminal, and ensure that both the VG and VD grounds are also connected to this ground terminal.
3. Apply -6V to VG.
4. Apply 65V to VD.
5. Increase V_G until drain current reaches 440mA or desired bias point.
6. Turn on the RF input.

IMPORTANT NOTE: Depletion mode device, when biasing the device V_G must be applied BEFORE V_D . When removing bias V_D must be removed BEFORE V_G is removed. Failure to follow sequencing will cause the device to fail.

NOTE: For optimal RF performance, consistent and optimal heat removal from the base of the package is required. A thin layer of thermal grease should be applied to the interface between the base of the package and the equipment chassis. It is recommended a small amount of thermal grease is applied to the underside of the device package. Even application and removal of excess thermal grease can be achieved by spreading the thermal grease using a razor blade. The package should then be bolted to the chassis and input and output leads soldered to the circuit board.

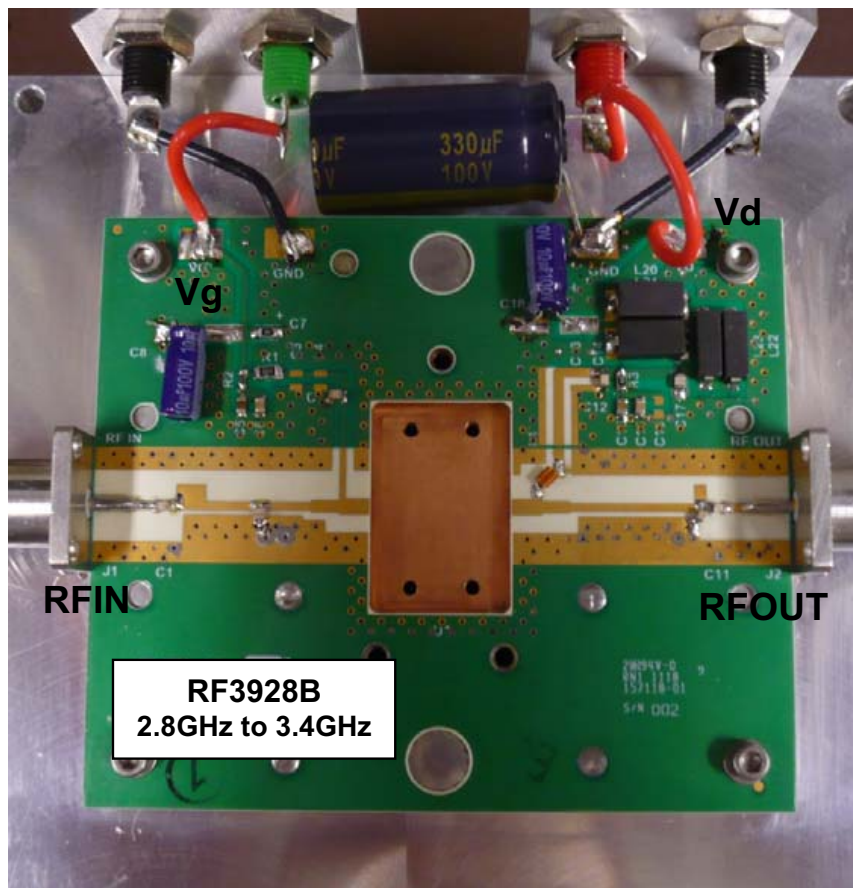

Evaluation Board Schematic

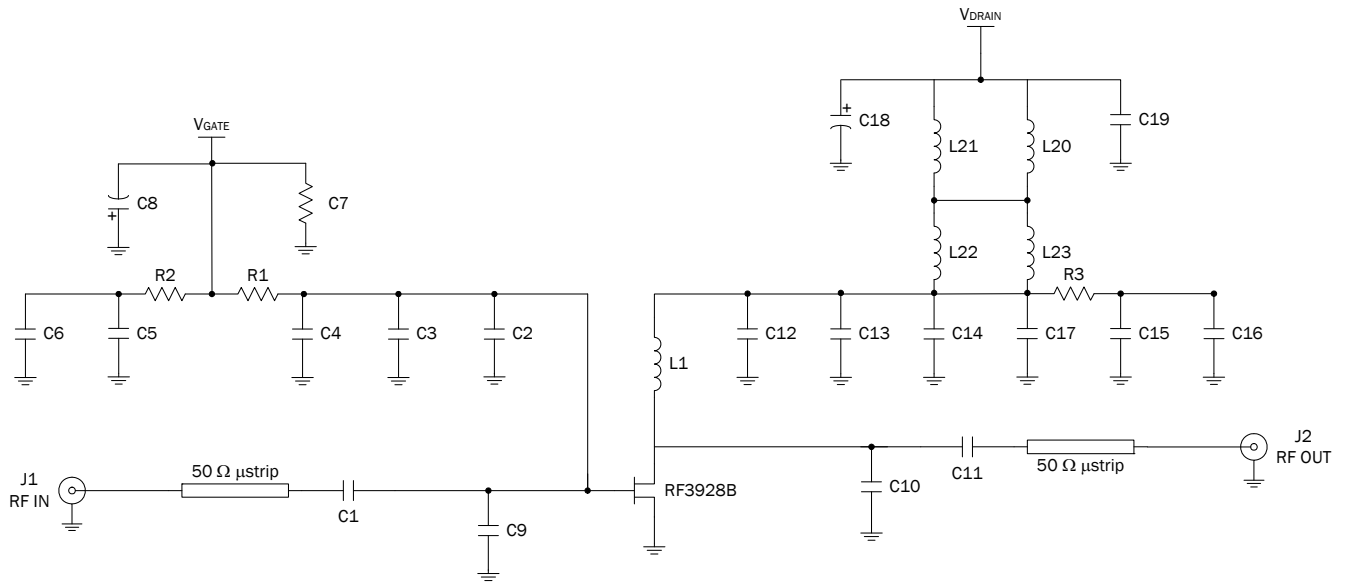

Evaluation Board Bill of Materials

Component	Value	Manufacturer	Part Number
R1	10Ω	Panasonic	ERJ-8GEYJ100V
R2	0Ω	Panasonic	ERJ-3GEYOR00
R3	51Ω	Panasonic	ERJ-8GEYJ510
C1, C11	22 pF	ATC	ATC100A220JT
C2, C14	15 pF	ATC	ATC100A150JT
C5, C16	1000 pF	Novacap	0805G102M101NT
C6, C15	10000 pF	TDK	C2012X7R2A103M
C7	120Ω	Panasonic	ERJ-6GEYJ120V
C8, C18	10 μF	Panasonic	EEU-FC2A100
C9	0.7 pF	ATC	ATC100A0R7BT
C10	0.2 pF	ATC	ATC100A0R2BT
C17	62 pF	ATC	ATC100B620JT
L1	22 nH	Coilcraft	0807SQ-22N_LC
L20, L21	115Ω, 10A	Steward	28F0181-1SR-10
L22, L23	75Ω, 10A	Steward	35F0121-1SR-10
C19	330 μF	Illinois Capacitor	9337CKE100M
C3, C4, C7, C12, C13	NOT POPULATED		

Evaluation Board Layout

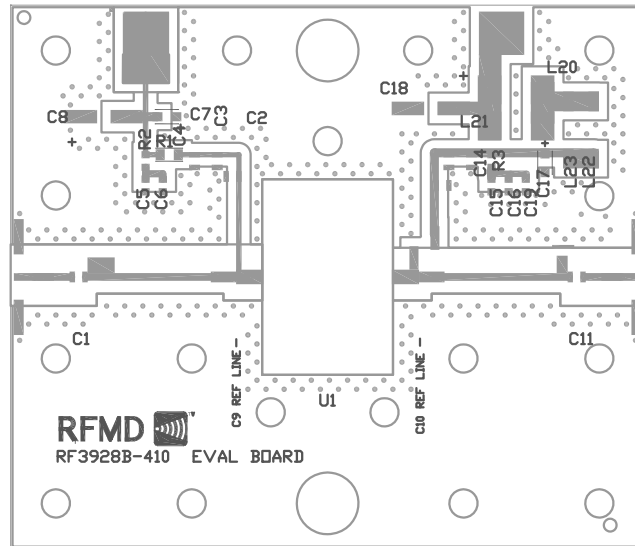

Device Impedances

Frequency (MHz)	Z Source (Ω)	Z Load (Ω)
2800	60.4 - j0.5	42.1 - j30.5
3000	51.9 - j13.5	33.8 - j25.7
3200	44.1 - j16.5	29.5 - j8.9
3400	38.3 - j16.7	17.0 - j9.0

NOTE: Device impedances reported are the measured evaluation board impedances chosen for a trade off of peak power, peak efficiency and gain performance across the entire frequency bandwidth.

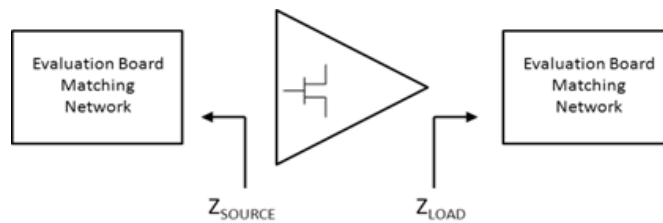

Device Handling/Environmental Conditions

GaN HEMT devices are ESD sensitive materials. Please use proper ESD precautions when handling devices or evaluation boards.

GaN HEMT Capacitances

The physical structure of the GaN HEMT results in three terminal capacitors similar to other FET technologies. These capacitances exist across all three terminals of the device. The physical manufactured characteristics of the device determine the value of the C_{DS} (drain to source), C_{GS} (gate to source) and C_{GD} (gate to drain). These capacitances change value as the terminal voltages are varied. RFMD presents the three terminal capacitances measured with the gate pinched off ($V_{GS} = -8V$) and zero volts applied to the drain. During the measurement process, the parasitic capacitances of the package that holds the amplifier is removed through a calibration step. Any internal matching is included in the terminal capacitance measurements. The capacitance values presented in the typical characteristics table of the device represent the measured input (C_{ISS}), output (C_{OSS}), and reverse (C_{RSS}) capacitance at the stated bias voltages. The relationship to three terminal capacitances is as follows:

$$C_{ISS} = C_{GD} + C_{GS}$$

$$C_{OSS} = C_{GD} + C_{DS}$$

$$C_{RSS} = C_{GD}$$

DC Bias

The GaN HEMT device is a depletion mode high electron mobility transistor (HEMT). At zero volts V_{GS} the drain of the device is saturated and uncontrolled drain current will destroy the transistor. The gate voltage must be taken to a potential lower than the source voltage to pinch off the device prior to applying the drain voltage, taking care not to exceed the gate voltage maximum limits. RFMD recommends applying $V_{GS} = -5V$ before applying any V_{DS} .

RF Power transistor performance capabilities are determined by the applied quiescent drain current. This drain current can be adjusted to trade off power, linearity, and efficiency characteristics of the device. The recommended quiescent drain current (I_{DQ}) shown in the RF typical performance table is chosen to best represent the operational characteristics for this device, considering manufacturing variations and expected performance. The user may choose alternate conditions for biasing this device based on performance trade off.

Mounting and Thermal Considerations

The thermal resistance provided as R_{TH} (junction to case) represents only the packaged device thermal characteristics. This is measured using IR microscopy capturing the device under test temperature at the hottest spot of the die. At the same time, the package temperature is measured using a thermocouple touching the backside of the die embedded in the device heatsink but sized to prevent the measurement system from impacting the results. Knowing the dissipated power at the time of the measurement, the thermal resistance is calculated.

In order to achieve the advertised MTTF, proper heat removal must be considered to maintain the junction at or below the maximum of 200 °C. Proper thermal design includes consideration of ambient temperature and the thermal resistance from ambient to the back of the package including heatsinking systems and air flow mechanisms. Incorporating the dissipated DC power, it is possible to calculate the junction temperature of the device.