



Chipsmall Limited consists of a professional team with an average of over 10 year of expertise in the distribution of electronic components. Based in Hongkong, we have already established firm and mutual-benefit business relationships with customers from,Europe,America and south Asia,supplying obsolete and hard-to-find components to meet their specific needs.

With the principle of “Quality Parts,Customers Priority,Honest Operation,and Considerate Service”,our business mainly focus on the distribution of electronic components. Line cards we deal with include Microchip,ALPS,ROHM,Xilinx,Pulse,ON,Everlight and Freescale. Main products comprise IC,Modules,Potentiometer,IC Socket,Relay,Connector.Our parts cover such applications as commercial,industrial, and automotives areas.

We are looking forward to setting up business relationship with you and hope to provide you with the best service and solution. Let us make a better world for our industry!



## Contact us

Tel: +86-755-8981 8866 Fax: +86-755-8427 6832

Email & Skype: info@chipsmall.com Web: www.chipsmall.com

Address: A1208, Overseas Decoration Building, #122 Zhenhua RD., Futian, Shenzhen, China



# RF DIGITAL

C O R P O R A T I O N

13715 Alton Pkwy • Irvine • CA • 92618  
Tel: 949.610.0008 • Fax: 949.610.0009  
www.rfdigital.com • sales@rfdigital.com

[RF.Digital.nRF24LE1.Module.Manual.doc](#)

**2.4GHz RF Modules (based on nRF24LE1)**  
**RFD21731, RFD21732, RFD21733, RFD21734, RFD21735,**  
**RFD21736, RFD21737, RFD21738**

## **Preliminary Datasheet**

12/29/2008 1:17 PM

**This document is being updated on a daily basis, always check for updates.**

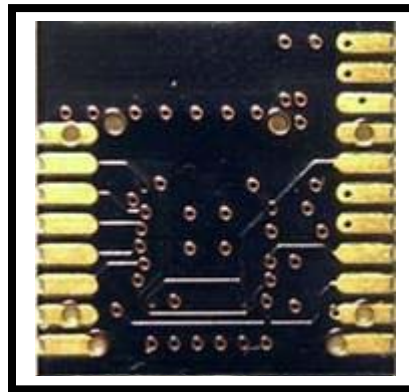

## **Features**

- Complete radio transceiver in a single package
  - Nordic Semiconductor nRF24LE1-F16Q24 microcontroller and 2.4GHz radio
  - Chip antenna (RFD21731, RFD21732, RFD21733)
  - External antenna (RFD21734, RFD21735)
  - Matching network
  - Voltage regulation
  - RF shielding (suitable for FCC, IC and CE compliance)
  - Includes 32KHz crystal for real-time clock (RFD21732, RFD21734)
- No RF knowledge required
- No RF layout required
- No external RF components required
- Single 1.9V to 3.3V supply
- Small size: 15 x 15 x 3mm
- Tape and Reeled packaging
- Easy to lay out 19-land SMT package with 0.050 inch (1.27mm) pitch.
- Typical range: 300 ft outdoors, 75 ft indoors



**13715 Alton Pkwy • Irvine • CA • 92618**  
**Tel: 949.610.0008 • Fax: 949.610.0009**  
**www.rfdigital.com • sales@rfdigital.com**

- Available with factory-programmed firmware which provides the following modes:
  - 9600-baud UART
  - 3 logic inputs
  - 3 logic outputs
  - Active RFID
- CE (ETSI), IC and FCC compliance approvals (pending)
- Evaluation boards available for rapid application development
- RoHS compliant



13715 Alton Pkwy • Irvine • CA • 92618  
Tel: 949.610.0008 • Fax: 949.610.0009  
www.rfdigital.com • sales@rfdigital.com

## Overview

The RFD21731, RFD21732, RFD21733, RFD21734, and RFD21735 are integrated modules based on the Nordic Semiconductor nRF24LE1-F16Q24 single-chip microcontroller and 2.4GHz radio transceiver IC. All digital signals from the nRF24LE1 are routed to external contacts on the RFD2173x module, but all of the RF signals are handled internal to the module for maximum RF performance, with no effort required on the part of the module user.

## About Nordic Semiconductor

Nordic Semiconductor manufactures the nRF24LE1 IC and provides development kits, reference designs, and example firmware. For more information on the nRF24LE1 contact Nordic Semiconductor by visiting their web site at <http://www.nordicsemi.com> or contact your Nordic distributor.

The Nordic nRF24LE1 data sheet is required for developing firmware for the RFD2173x modules that are not shipped with factory-loaded firmware. The data sheet is available for download on Nordic Semiconductor's website.

## About RF Digital

RF Digital manufactures the RFD21731, RFD21732, RFD21733, RFD21734, RFD21735 modules based on the nRF24LE1-F16Q24, and provides the RFDP8 firmware that enables the most common functions which RF Digital customers have requested. When using a module with the RFDP8 firmware, the designer needs only to connect the digital I/O lines for the function selected; no further programming of the RFD21733 or RFD21735 module is required.





13715 Alton Pkwy • Irvine • CA • 92618  
Tel: 949.610.0008 • Fax: 949.610.0009  
www.rfdigital.com • sales@rfdigital.com

## Table of Contents

Pin Configuration .....	5
Pin Descriptions .....	5
Ordering Information.....	6
RFDP8 Firmware .....	6
Interference Immunity Algorithm .....	7
Electronic Serial Number .....	7
Network Mode.....	7
Mode 0 – Active RFID Transmitter .....	8
Reference Schematic .....	8
Mode 1 – Input Logic Transmitter .....	9
Modes 2 and 3 – 9600 baud UART.....	9
End-to-End Latency.....	10
Bi-Directional IO Signal Operation.....	11
ESN Read-back.....	11
Reference Schematic .....	12
Modes 4-7 – Receiver with Logic Output .....	12
Reference Schematic .....	13
Communication between UART and Switch Logic Receiver/Transmitter.....	14
Logic Transmitter to UART .....	14
UART to Logic Receiver .....	14
Recommended PCB Layout .....	15
Evaluation Boards .....	16
Nordic nRFGo Development kit .....	16
Stand-alone, battery-powered evaluation board .....	16
Electrical Characteristics .....	18
Operating Conditions .....	18
Power Consumption.....	18
Logic Transmitter or Active RFID Transmitter .....	18
Logic Receiver.....	18
UART.....	18
Mechanical Details .....	19
PCB Layout.....	19
Overall Dimensions, top view.....	20
Overall Dimensions, side view .....	20
Important Notice .....	21





13715 Alton Pkwy • Irvine • CA • 92618  
 Tel: 949.610.0008 • Fax: 949.610.0009  
 www.rfdigital.com • sales@rfdigital.com

## Ordering Information

The RFD2173x modules are available with a variety of options. Customized versions are also available; contact RF Digital for more information.

Model	RFDP8 firmware	Chip Antenna	32KHz crystal	Pending Approvals
RFD21731		✓	<sup>(1)</sup>	CE, ETSI
RFD21732		✓	✓ <sup>(1)</sup>	CE, ETSI
RFD21733	✓	✓		CE, ETSI, FCC, IC
RFD21734		<sup>(2)</sup>	✓ <sup>(1)</sup>	CE, ETSI
RFD21735	✓	<sup>(2)</sup>		CE, ETSI

### Notes:

1. The RFD21731 makes all 7 of the nRF24LE1-F16Q24's I/O signals available for user-written firmware. The RFD21732 and RFD21734 use 2 of those I/O signals for the 32KHz crystal, and so only 5 remain for user-written firmware.
2. The RFD21734 and RFD21735 require that the application circuit use pin 11 (EXT\_ANT) to connect to an appropriate antenna for the application, such as a Wire, PCB trace or SMA connector to an external antenna.

## RFDP8 Firmware

RF Digital offers firmware for the RFD21733 and RFD21735 modules which meets many common user requirements. The firmware and a unique identifier are pre-programmed and tested at the factory. The programmed module is therefore immediately ready for use upon delivery.

The RFDP8 firmware uses inputs P0.0, P0.1, and P0.2 to select the operating mode. These inputs are sampled when the nRF24LE1 comes out of reset, and should be pulled up to VDD or pulled down to GND to select the appropriate mode.

P0.2	P0.1	P0.0	Mode
0	0	0	Active RFID transmitter
0	0	1	Switch Input logic transmitter
0	1	x	9600 baud UART
1	x	x	Switch Output Logic Receiver

Some of the operating modes have additional options which are described in the section for that mode.



13715 Alton Pkwy • Irvine • CA • 92618  
Tel: 949.610.0008 • Fax: 949.610.0009  
www.rfdigital.com • sales@rfdigital.com

Other than selecting an operating mode, the RFDP8 firmware cannot be modified by the user. For applications that require alternative functionality, contact RF Digital for information about custom firmware.

### **Interference Immunity Algorithm**

The RFDP8 firmware employs RF Digital's Proprietary, Patent Pending Interference Immunity Algorithm, which successfully functions in a WiFi environment without performance degradation. In addition, RF Digital's protocol provides a robust communication link in high RF noise environments.

### **Electronic Serial Number**

Every RF Digital Module has its own 32-bit unique identifier (up to 4 billion unique serial numbers), known as the electronic serial number, or ESN. This value is assigned at the factory and cannot be changed by the user.

The ESN is included in every packet that is transmitted, as part of the protocol overhead and is transparent to the user.

The user does not ordinarily need to know what the ESN is. However, in certain cases it is helpful to know the serial number, and so a mechanism has been provided to read out the ESN. This method is documented in the UART section below.

### **Network Mode**

The UART and the Receiver with logic output can be configured to accept data only from transmitters with which it has been associated, i.e. in its network.

When in network mode, a module must “learn” the ESN of any module which it wishes to “hear.” The LEARN signal (P0.3, listed in the UART and receiver sections below) is usually an input, pulled to GND. When LEARN is driven high for at least 20ms and then allowed to return to GND, the module enters learning mode.

While in learning mode, the LEARN signal is changed to an output and driven high. During this time, the module will learn the ESN of the first module that sends any data; the data will be discarded, the ESN of the transmitting module will be learned by the receiving module. The receiving module indicates that it has learned the ESN by toggling the LEARN output on and off quickly three times.

After learning the transmitting modules ESN, or after 10 seconds pass, the module will exit learning mode by driving LEARN low and then changing it back to an input.

Modules can learn up to 60 unique ESN's. ESN's cannot be deleted individually. The list of learned ESN's can be completely cleared by holding the LEARN signal high for 10 seconds





13715 Alton Pkwy • Irvine • CA • 92618  
Tel: 949.610.0008 • Fax: 949.610.0009  
www.rfdigital.com • sales@rfdigital.com

and then releasing it. The module will erase its ESN list, and drive the LEARN signal in an alternating high/low pattern for a few seconds to indicate that the ESN list is now empty.

Once a module has learned the ESN of another module, it will accept any and all data from that module only and not any other modules. Up to 60 unique transmitters can be taught to one receiver.

This network feature can be used for peer-to-peer networks, point to multi-point networks, or multi-point to multi-point networks. The association can be between two units for simple functions like opening a garage door or with many units to form complex networks with multiple nodes.

### Mode 0 – Active RFID Transmitter

Pin	Direction	Function
P0.0	Input	Pull to GND
P0.1	Input	Pull to GND
P0.2	Input	Pull to GND
P0.3	Output	Toggles high during transmission
P0.4	Input	Active high switch input #1
P0.5	Input	Active high switch input #2
P0.6	Input	Active high switch input #3

The Active RFID Transmitter transmits a packet with its ESN every 2 seconds when the three inputs are all at a low logic level. If any of the three inputs go high, the module transmits the state of all three inputs every 15 ms, until all three inputs are low.

The module is active during transmit for 15ms, but remains in an ultra-low power mode for the rest of the 2 second interval. The average power over time is measured in microamps, such that a CR2032 battery should provide about 60 days of continuous use.

If longer periods of use are required, a larger battery can be used to allow it to run up to years of time without replacing the battery, or contact RF Digital to inquire about a custom time setting which will reduce the transmission interval thus reducing the average power consumption.

### Reference Schematic

(A reference schematic will show the module with 3 active-high buttons on the logic inputs, and an active-high LED on the LEARN signal.)



13715 Alton Pkwy • Irvine • CA • 92618  
Tel: 949.610.0008 • Fax: 949.610.0009  
www.rfdigital.com • sales@rfdigital.com

### Mode 1 – Input Logic Transmitter

Pin	Direction	Function
P0.0	Input	Pull to VDD
P0.1	Input	Pull to GND
P0.2	Input	Pull to GND
P0.3	Output	Toggles high during transmission
P0.4	Input	Active high switch input #1
P0.5	Input	Active high switch input #2
P0.6	Input	Active high switch input #3

When all three switch inputs are low, the module does not transmit, but remains in an ultra-low-power state.

When any of the three switch inputs go high, the module transmits the state of all three inputs. As long as any of the three inputs remain high, the module continues to transmit the state of all three inputs every 15ms.

The reference schematic for Mode 1 is identical to that for Mode 0, except that the inputs on P0.[4:6] are mandatory.

### Modes 2 and 3 – 9600 baud UART

Pin	Direction	Function
P0.0	Input	Pull to VDD for network mode, otherwise pull to GND
P0.1	Input	Pull to VDD
P0.2	Input	Pull to GND
P0.3	I/O	In network mode, used for the <b>LEARN</b> signal
	N/C	Don't care if not in network mode
P0.4	I/O	<b>IO</b> – Bi-directional general-purpose signal
P0.5	Output	<b>RX_out</b> – UART output of received data
P0.6	Input	<b>TX_in</b> – UART input of data to transmit

Modes 2 and 3 provide a 9600 baud half-duplex UART, suitable for connection to a microcontroller, or a level translator (such as a MAX202) to an RS-232 port. RF transmission takes priority over RF reception, so that a module will not receive anything over the air if it is given a full-speed stream of serial data on TX\_in.

The UART is configured for 9600 baud, 8 data bits, 1 stop bit, and no parity. Because the module does not perform any parity checking on the data stream, it is possible to use 7 data bits and even or odd parity instead of 8 data bits with no parity.



13715 Alton Pkwy • Irvine • CA • 92618  
Tel: 949.610.0008 • Fax: 949.610.0009  
www.rfdigital.com • sales@rfdigital.com

When in UART mode, the module must remain in an active state with the radio enabled in receive mode.

### End-to-End Latency

In order to use the radio efficiently, the RFDP8 firmware buffers data received from the UART into packets which are transmitted over the radio. The firmware transmits a packet when it has buffered 12 bytes of data, or 15ms after receiving a byte of data. On the receiving end, data will be transmitted over the UART at line speed, with no pauses between the bytes (other than the RS-232 start and stop bits). The buffering allows for the RFDP8 to support a full 9600 baud data rate.

The buffering and latency may cause problems with certain applications, such as the BASIC Stamp from Parallax Inc., which incur delays when changing from one input format to another. One possible solution is to add a 16ms delay on the transmitting side every time the output format changes, to give the receiving side time to change formats. Another solution involves “pacing” the UART to send a single byte of data every 16ms, so that each byte will be sent in its own packet.

As an example, consider a scenario where one system is sending a byte of data every 8ms. When module 1 receives the 1<sup>st</sup> byte on its UART, the 15ms timer begins. The 2<sup>nd</sup> byte arrives before 15ms elapses, and so the first two bytes are sent in a single packet over the air to Module 2. Module 2 will transmit the bytes on its UART with no delay between them. Module 1 receives the third byte on its UART, and re-starts the 15ms timer. As with the 2<sup>nd</sup> byte, the 4<sup>th</sup> byte arrives before 15ms elapses, and so the 3<sup>rd</sup> and 4<sup>th</sup> bytes are also sent in a single packet over the air, as illustrated in the following timing diagram.

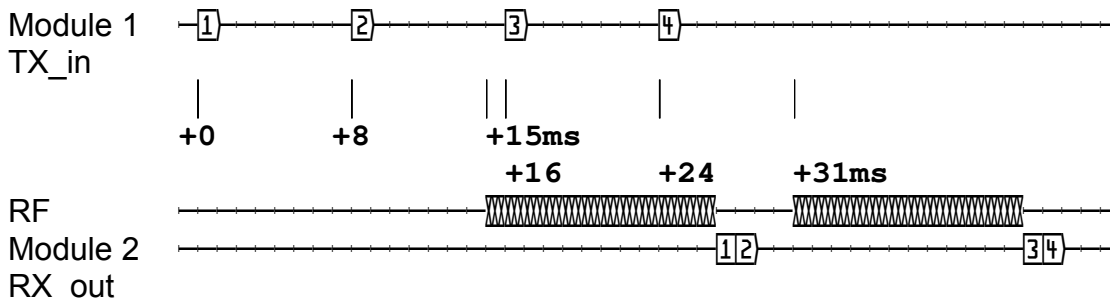

(Example code for the BASIC Stamp will show mixed-format input and output (i.e. an integer followed by a string), with a choice of a fixed delay when changing of formats, or using per-byte pacing.)



13715 Alton Pkwy • Irvine • CA • 92618  
Tel: 949.610.0008 • Fax: 949.610.0009  
www.rfdigital.com • sales@rfdigital.com

### Bi-Directional IO Signal Operation

UART mode includes an additional bi-directional general-purpose IO line. The IO signal is generally an input, and should be pulled to GND with an appropriately sized resistor. If the IO signal is driven high, the module will transmit this information, and any UART which receives the data will turn its IO signal into an output and drive it high. This will continue until 20ms pass without receiving any new data, or until the module receives a packet which indicates that the IO signal should be driven low and turned back to an input. The state of the IO signal does not require any extra data in the radio stream, and so is “free” in the packet overhead.

When the module is driving its IO signal high, it will periodically change the pin to an input and check to see if it remains high, before changing it back to an output. This may cause a momentary dip in the signal (less than 1ms every 12ms), and so any circuitry which relies on a steady-state output from the IO signal should include conditioning (for example a retriggerable one-shot with a hold time of 2ms) to avoid adverse effects.

### ESN Read-back

In certain applications, it is helpful to know the ESN of a module. There is a provision in both UART modes to read back the ESN when the module comes out of reset. ESN read-back is not available in any of the other modes.

To activate ESN read-back:

1. Place the module in a reset state by holding the /RESET signal low.
2. Hold the LEARN signal high.
3. Release the /RESET signal.
4. Wait 250ms. If the LEARN signal goes low at any time during this 250ms interval, the module immediately exits ESN read-back mode.
5. Release the LEARN signal.
6. Send the string “READ ESN” (all capitals, one space between the two words) at 9600-8N1 into the module on the TX\_in signal (P0.6). If this string is not received within 1 second, the module exits ESN read-back mode.

The module will respond with the ESN and a firmware identifier on the RX\_out signal (P0.5) at 9600-8N1, and then exit ESN read-back mode. An example of the output is:

```
314CE686:RFDP8 v1.2    11/18/08 08:45:16$
```

The ESN is 8 characters, representing a 32-bit number in hexadecimal format. A colon separates the ESN from the Firmware ID. The Firmware ID is 32 bytes long. The output is terminated with a carriage return/line feed pair.

When the module exits ESN read-back mode, or if the LEARN signal is not high when the module exits reset, the module will enter regular operation in Mode 2 or 3, according to the mode select signals.



13715 Alton Pkwy • Irvine • CA • 92618  
Tel: 949.610.0008 • Fax: 949.610.0009  
www.rfdigital.com • sales@rfdigital.com

### Reference Schematic

(A reference schematic will show the module with a MAX202 or similar level translator, a DB9F suitable for connecting to a PC, an active-high button and active-high LED connected to the IO signal, and an option active-high button and active-high LED connected to the LEARN signal.)

### Modes 4-7 – Receiver with Logic Output

Pin	Direction	Function
P0.0	Input	Pull to VDD for network mode, otherwise pull to GND
P0.1	Input	Pull to VDD for 20ms hang time, otherwise pull to GND
P0.2	Input	Pull to VDD
P0.3	I/O	In network mode, used for the <b>LEARN</b> signal
	N/C	Don't care if not in network mode
P0.4	Output	Active high logic output #1
P0.5	Output	Active high logic output #2
P0.6	Output	Active high logic output #3

In modes 4 through 7, the module is always in receiving mode.

The receiver drives its outputs to match the values received in a packet from a transmitter. This allows up to 8 possible ( $2^3$ ) combinations on the receiver's outputs.

Since a transmitter does not send any data when all of its inputs are low, there must be a mechanism for turning off the receiver's outputs in the absence of data. When P0.1 is pulled to VDD, the receiver will maintain its output state for 500ms or until it receives new data, whichever comes first. The 500ms is referred to as the "hang time," or the time that the outputs will "hang" in the absence of new data. If P0.1 is pulled to GND, the hang time is 20ms.

Hang time is a trade-off between latency and resiliency to packet loss. With all RF systems sometimes a packet will be lost, especially as the distance between the transmitter and the receiver grows. If an output is connected to a relay driver, packet loss will result in chattering on the relay, which will not have good results. The 500ms hang time is perfect for applications like a keyless entry system or a garage door opener.

For faster switching to the "all off" state, the 20ms hang time is preferred. Since a transmitter sends new data every 15ms, the time delay to turn off all outputs is only 5ms more than to update the outputs to a different state where at least one of them is still driven high.

13715 Alton Pkwy • Irvine • CA • 92618  
Tel: 949.610.0008 • Fax: 949.610.0009  
www.rfdigital.com • sales@rfdigital.com

The following timing diagrams show the operation of a logic transmitter and a logic receiver with the different hang time options.

In the first diagram, the logic transmitter's inputs are all asserted, and then sequentially de-asserted. There is a small delay between the transmitter input going high and the corresponding output on the receiver going high, due to the time required to transmit over the air.

Note that when the last input on the transmitter is de-asserted, there is a 500ms delay before the receiver de-asserts its last output.

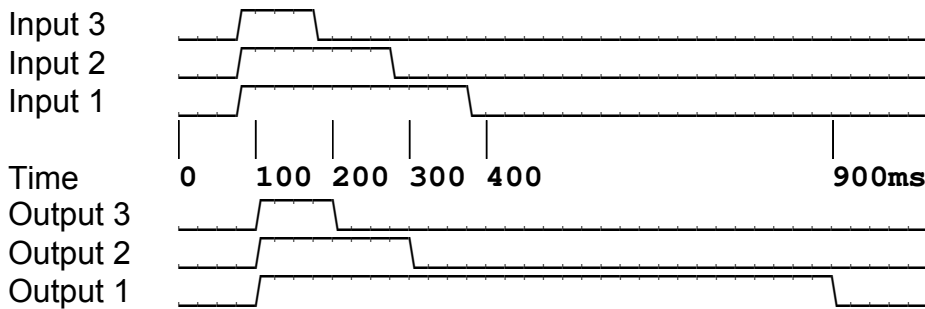

The second diagram shows the same operation at the transmitter, but with the receiver configured with a 20ms hang time.

Note that shortly after the last input is de-asserted, the receiver updates its output state to turn off all outputs.

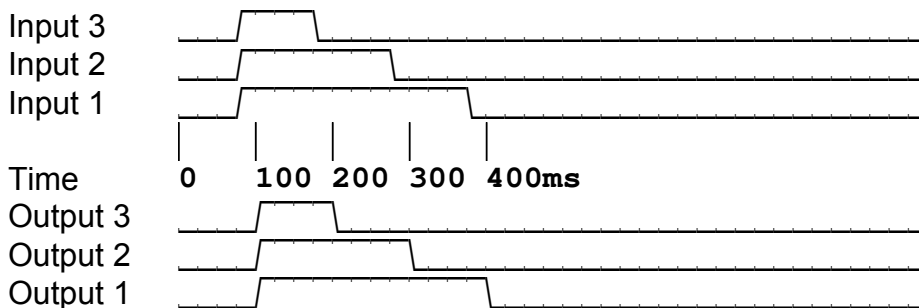

### Reference Schematic

(A reference schematic will show the module with 3 active-high LED's connected to the logic outputs, and an optional active-high button and active-high LED connected to the LEARN signal.)





13715 Alton Pkwy • Irvine • CA • 92618  
 Tel: 949.610.0008 • Fax: 949.610.0009  
 www.rfdigital.com • sales@rfdigital.com

### Communication between UART and Switch Logic Receiver/Transmitter

The Logic Receiver and Transmitter modes are able to communicate with a module operating in one of the UART modes, which opens up a wide range of possible applications involving PC's or embedded systems with serial communications capability.

#### Logic Transmitter to UART

A Logic Transmitter (whether RFID or not) sends the state of its inputs as a single byte of data, followed by its ESN as four bytes. A UART can receive this packet and output it as a binary stream to a PC serial port or an embedded microcontroller. The format of the data is:

Byte	Bit 7	Bit 6	Bit 5	Bit 4	Bit 3	Bit 2	Bit 1	Bit 0
1		Input 3	Input 2	Input 1				RFID
2	ESN Byte 1							
3	ESN Byte 2							
4	ESN Byte 3							
5	ESN Byte 4							

In the first byte, bits 6 through 4 carry the state of the logic inputs, with a '1' indicating the logic input on the transmitter is high, and a '0' indicating it is low. Bit 0 is a flag to indicate if this is a periodic transmission from an RFID Transmitter, and is set to '1' if this is the case. All other bits in the first byte are set to '0'.

For example, if an RFID Transmitter with ESN 314CE686 sent a packet on its 2-second interval, a UART would receive the bytes 01 31 4C E6 86 in binary format.

If input #3 on that same RFID transmitter were pulled high, the UART would receive the bytes 40 31 4C E6 86 in binary format.

Most ESN's will contain at least one unprintable character, and so this data will not be suitable for displaying directly in a terminal package (such as HyperTerminal), but a PC-based program can collect the data and display it in a more friendly fashion.

The ESN which the UART receives is the same one that is in the packet header. If the UART is in Network Mode, and has not learned the ESN, it will never receive the packet, and there will be no output on the serial port.

#### UART to Logic Receiver

A UART can also send data to a logic receiver, which will decode the data and assert its outputs as though it received a packet from a logic transmitter. The data format is very similar



13715 Alton Pkwy • Irvine • CA • 92618  
 Tel: 949.610.0008 • Fax: 949.610.0009  
 www.rfdigital.com • sales@rfdigital.com

to the one described in the previous section. The differences matter only when the receiver is in Network Mode.

The UART must follow a packet with at least 15ms of no data so that all bytes as described below are sent as a single packet.

Note that a UART can send a single zero byte – all bits clear – to force a receiver to turn off its outputs immediately, regardless of hang time.

**Format 1:**

Byte	Bit 7	Bit 6	Bit 5	Bit 4	Bit 3	Bit 2	Bit 1	Bit 0
1		Output 3	Output 2	Output 1				

With a single byte of data, a receiver in Network Mode will use the UART’s ESN from the packet header to determine if it should accept the packet. This allows one UART to send the same data to multiple receivers, provided that each receiver has learned the UART’s ESN.

When the receiver is not in Network Mode, the receiver will accept any packet it receives, and so this is the preferred format.

**Format 2:**

Byte	Bit 7	Bit 6	Bit 5	Bit 4	Bit 3	Bit 2	Bit 1	Bit 0
1		Output 3	Output 2	Output 1				
2	ESN Byte 1							
3	ESN Byte 2							
4	ESN Byte 3							
5	ESN Byte 4							

To allow individual addressing of receivers in Network Mode, the UART can send a particular receiver’s ESN after the byte for the logic state. In this case, the receiver will only accept the packet if the ESN in the data portion matches the receiver’s own ESN.

If the receiver is actively learning ESN’s, it will learn only the ESN from the packet header; the ESN in the data portion will not be learned.

**Recommended PCB Layout**

(A PCB layout will show the module with the recommended power and GND connections, as well as recommended routing for all digital signals.)



13715 Alton Pkwy • Irvine • CA • 92618  
Tel: 949.610.0008 • Fax: 949.610.0009  
www.rfdigital.com • sales@rfdigital.com

## Evaluation Boards

RF Digital provides several evaluation boards for rapid application development. Two evaluation boards are required for complete product development.

Model	Description	Antenna	RFDP8 firmware
RFD21736	RFD21731 nRFGo board	Internal chip	
RFD21737	RFD21733 eval board	Internal chip	✓
RFD21738	RFD21735 eval board	Wire	✓
RFD21739	RFD21735 eval board	SMA <sup>(1)</sup>	✓

Notes:

1. User must supply the antenna.

## Nordic nRFGo Development kit

Nordic provides the nRFGo Starter Kit as two motherboards which accept pluggable modules with an nRF24LE1 chip in various package sizes and pinouts, and with options for an antenna including a trace antenna and an SMA connector.

The RFD21736 is compatible with the nRFGo Starter Kit, using the same connectors as the Nordic modules. This board has a RFD21731 mounted on it, and a 32 KHz crystal which can be selected by an on-board jumper.

The RFD21736 can be used to evaluate both the RFD21731 and RFD21732, since the only difference between the RFD21731 and RFD21732 is the on-board 32KHz crystal.

## Stand-alone, battery-powered evaluation board

RF Digital has developed a battery-powered evaluation board which can be used in a solderless breadboard or as a stand-alone platform. Features include:

- 12-pin 0.100" SIP header for easy prototyping
- CR2032 battery and holder
- 3-position DIP switch to select from all 8 modes
- Power switchable between battery or external power through the SIP header
- 3 push buttons for switch transmitter mode
- 3 LED's for switch receiver mode
- Serial UART mode
- RFID mode
- LEARN push button for network modes
- Status LED
- Available with SMA connector, Wire or Chip Antenna.
- Power down input.



**13715 Alton Pkwy • Irvine • CA • 92618**  
**Tel: 949.610.0008 • Fax: 949.610.0009**  
**www.rfdigital.com • sales@rfdigital.com**

- 1.25" x 2" (28 x 50mm) size

The evaluation board includes an RFD21733 or RFD21735 module loaded with RFDP8 8-mode firmware as described in this manual, and has various antenna options.



13715 Alton Pkwy • Irvine • CA • 92618  
Tel: 949.610.0008 • Fax: 949.610.0009  
www.rfdigital.com • sales@rfdigital.com

## Electrical Characteristics

### Operating Conditions

Symbol	Parameter	Minimum	Typical	Maximum
VDD	Supply voltage	1.9V	3.0V	3.6V
	Operating Temperature	-40°C		+85°C

Refer to the nRF24LE1 datasheet for more details.

### Power Consumption

Conditions: VDD = 3.0V, T<sub>A</sub> = +25°C

#### Logic Transmitter or Active RFID Transmitter

Parameter	Minimum	Typical	Maximum
Ultra-low power mode		1.8uA	
On-air		12.25mA	

#### Logic Receiver

Parameter	Minimum	Typical	Maximum
Listening - Receiving		17mA	

#### UART

Parameter	Minimum	Typical	Maximum
Listening - Receiving		17mA	
Transmitting		14mA	

13715 Alton Pkwy • Irvine • CA • 92618  
Tel: 949.610.0008 • Fax: 949.610.0009  
www.rfdigital.com • sales@rfdigital.com

## Mechanical Details

### PCB Layout

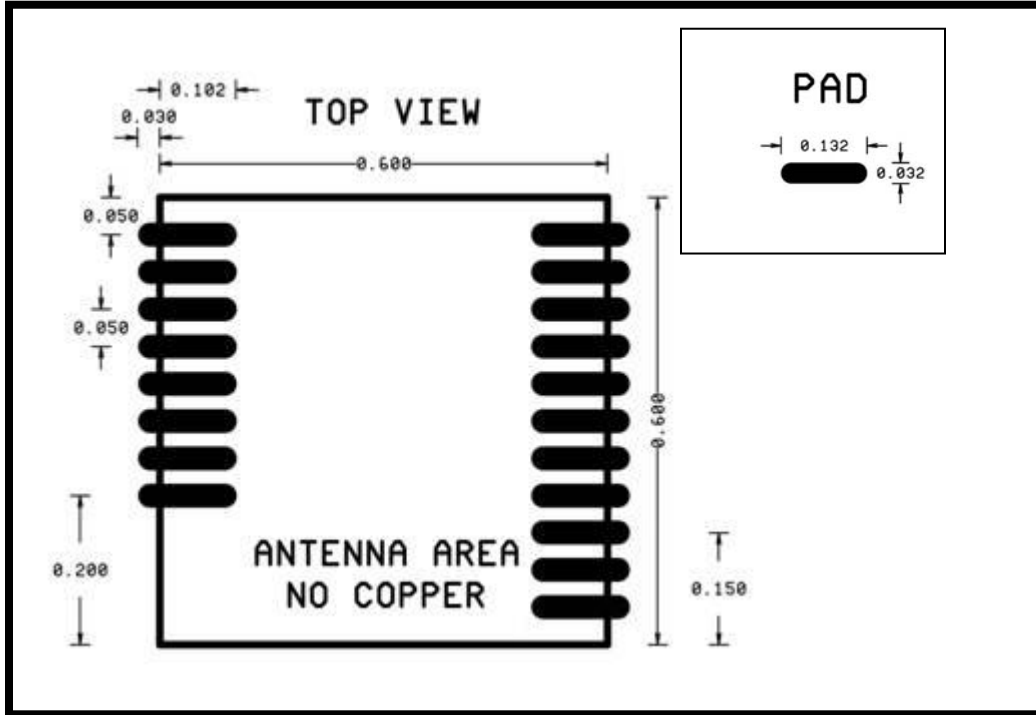



13715 Alton Pkwy • Irvine • CA • 92618  
Tel: 949.610.0008 • Fax: 949.610.0009  
www.rfdigital.com • sales@rfdigital.com

### Overall Dimensions, top view

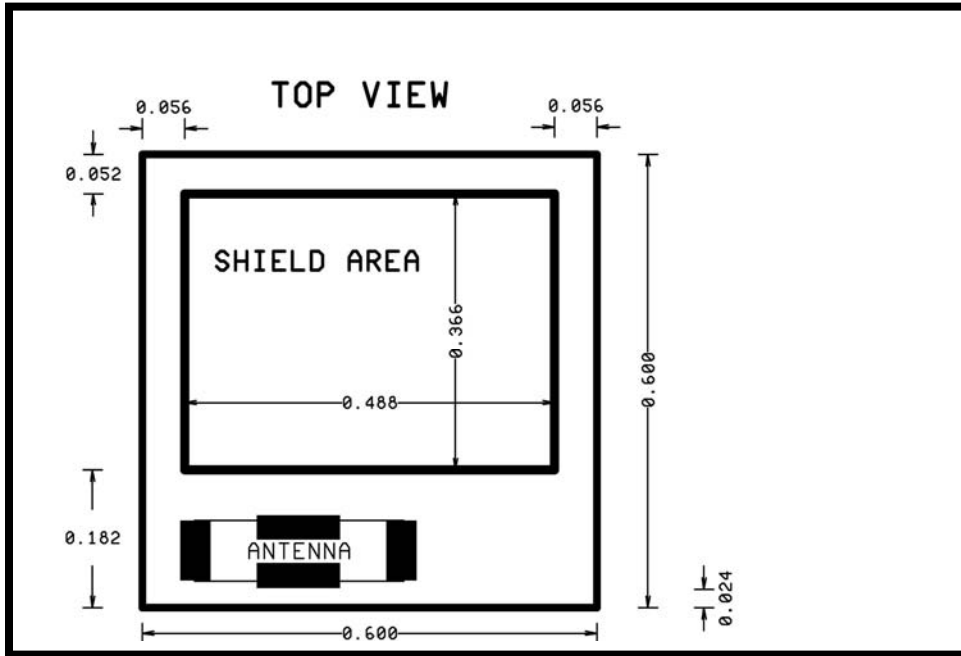

### Overall Dimensions, side view

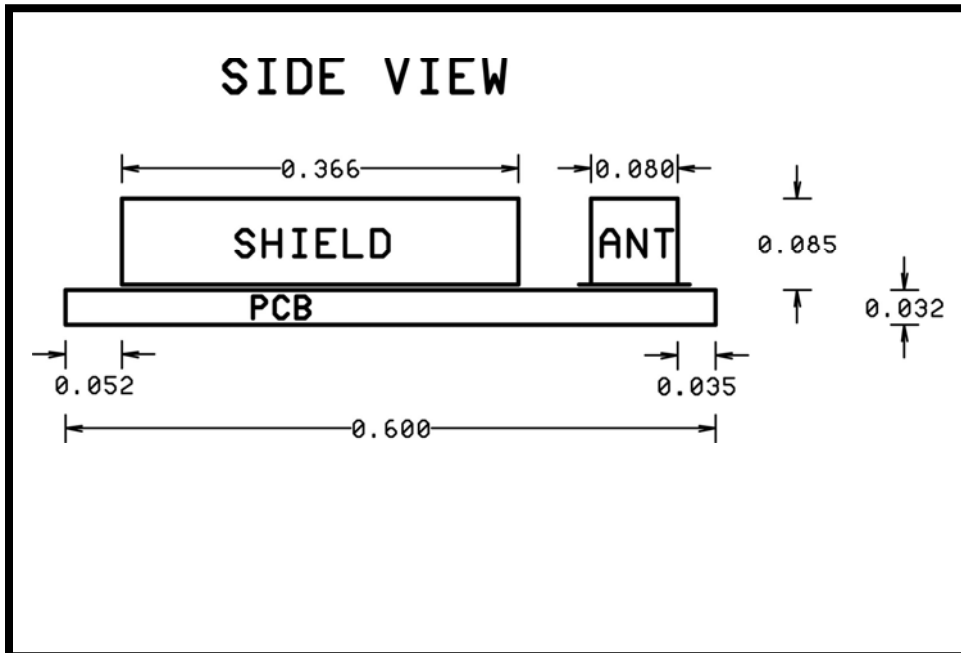



**13715 Alton Pkwy • Irvine • CA • 92618**  
**Tel: 949.610.0008 • Fax: 949.610.0009**  
**www.rfdigital.com • sales@rfdigital.com**

## **Important Notice**

RF Digital reserves the right to make corrections, modifications, and/or improvements to the product and/or its specifications at any time without notice.

RF Digital assumes no liability for the user's product and/or applications.

RF Digital products are not authorized for use in safety-critical applications, including but not limited to life-support applications.

RF Digital assumes no liability for parts or their application beyond replacement or refunding the original purchase price.

End of Document.