



Chipsmall Limited consists of a professional team with an average of over 10 year of expertise in the distribution of electronic components. Based in Hongkong, we have already established firm and mutual-benefit business relationships with customers from,Europe,America and south Asia,supplying obsolete and hard-to-find components to meet their specific needs.

With the principle of "Quality Parts,Customers Priority,Honest Operation,and Considerate Service",our business mainly focus on the distribution of electronic components. Line cards we deal with include Microchip,ALPS,ROHM,Xilinx,Pulse,ON,Everlight and Freescale. Main products comprise IC,Modules,Potentiometer,IC Socket,Relay,Connector.Our parts cover such applications as commercial,industrial, and automotives areas.

We are looking forward to setting up business relationship with you and hope to provide you with the best service and solution. Let us make a better world for our industry!



Contact us

Tel: +86-755-8981 8866 Fax: +86-755-8427 6832

Email & Skype: info@chipsmall.com Web: www.chipsmall.com

Address: A1208, Overseas Decoration Building, #122 Zhenhua RD., Futian, Shenzhen, China



RFPD2930

GaAs/GaN Power Doubler Hybrid
45MHz to 1003MHz

The RFPD2930 is a Hybrid Power Doubler amplifier module. The part employs GaAs pHEMT die and GaN HEMT die, has extremely high output capability, and is operated from 45MHz to 1003MHz. It provides excellent linearity and superior return loss performance with low noise and optimal reliability. DC current of the device can be externally adjusted for optimum distortion performance versus power consumption over a wide range of output level.

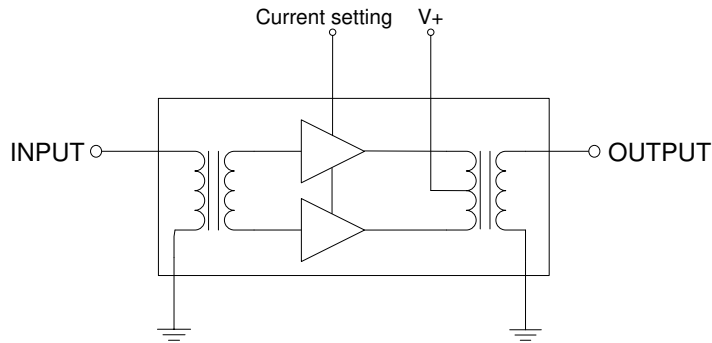

Ordering Information

RFPD2930 Box with 50 Pieces

Absolute Maximum Ratings

Parameter	Rating	Unit
RF Input Voltage (single tone)	75	dBmV
DC Supply Over-Voltage (5 minutes)	30	V
Storage Temperature	-40 to +100	°C
Operating Mounting Base Temperature	-30 to +100	°C



Package: SOT-115J

Features

- Excellent Linearity
- Superior Return Loss Performance
- Extremely Low Distortion
- Optimal Reliability
- Low Noise
- Unconditionally Stable Under All Terminations
- Extremely High Output Capability
- 24.5dB Min. Gain at 1003MHz
- 450mA Max. at 24V_{DC}
- Extra Pin For Current Adjustment

Applications

- 45MHz to 1003MHz CATV Amplifier Systems



Caution! ESD sensitive device.



RoHS (Restriction of Hazardous Substances): Compliant per EU Directive 2011/65/EU.

Exceeding any one or a combination of the Absolute Maximum Rating conditions may cause permanent damage to the device. Extended application of Absolute Maximum Rating conditions to the device may reduce device reliability. Specified typical performance or functional operation of the device under Absolute Maximum Rating conditions is not implied.

Nominal Operating Parameters

Parameter	Specification			Unit	Condition
	Min	Typ	Max		
General Performance					$V_+ = 24V$; $T_{MB} = 30^\circ C$; $Z_S = Z_L = 75\Omega$, $IDC \text{ set} > 370mA$
Power Gain	23.3	23.8	24.3	dB	$f = 45MHz$
	24.5	25.0	26.0	dB	$f = 1003MHz$
Slope ^[1]	0.5	1.0	2.0	dB	$f = 45MHz \text{ to } 1003MHz$
Flatness of Frequency Response			0.8	dB	$f = 45MHz \text{ to } 1003MHz$
Input Return Loss	20			dB	$f = 45MHz \text{ to } 320MHz$
	19			dB	$f = 320MHz \text{ to } 640MHz$
	18			dB	$f = 640MHz \text{ to } 870MHz$
	16			dB	$f = 870MHz \text{ to } 1003MHz$
Output Return Loss	20			dB	$f = 45MHz \text{ to } 320MHz$
	19			dB	$f = 320MHz \text{ to } 640MHz$
	18			dB	$f = 640MHz \text{ to } 870MHz$
	17			dB	$f = 870MHz \text{ to } 1003MHz$
Noise Figure		3.0	4.0	dB	$f = 50MHz \text{ to } 1003MHz$
Total Current Consumption (DC)		430.0	450.0	mA	[5]
Distortion Data					$V_+ = 24V$; $T_{MB} = 30^\circ C$; $Z_S = Z_L = 75\Omega$, $IDC = IDC \text{ typical}$ [2]
CTB		-73	-68	dBc	$V_O = 61.0dBmV \text{ at } 1000MHz$, 18dB extrapolated tilt, 79 analog channels plus 75 digital channels (-6dB offset) ^{[2][5]}
XMOD		-65	-60	dBc	
CSO		-76	-70	dBc	
CIN	55	60		dB	
Distortion Data					$V_+ = 24V$; $T_{MB} = 30^\circ C$; $Z_S = Z_L = 75\Omega$, $IDC = IDC \text{ typical}$ [2]
CTB		-77		dBc	$V_O = 56.4dBmV \text{ at } 1000MHz$, 13.4dB extrapolated tilt, 79 analog channels plus 75 digital channels (-6dB offset) ^{[3][5]}
XMOD		-71		dBc	
CSO		-71		dBc	
CIN		66		dB	
Distortion Data					$V_+ = 24V$; $T_{MB} = 30^\circ C$; $Z_S = Z_L = 75\Omega$, $IDC = 370mA$
CTB		-70		dBc	$V_O = 56.4dBmV \text{ at } 1000MHz$, 13.4dB extrapolated tilt, 79 analog channels plus 75 digital channels (-6dB offset) ^{[3][5]}
XMOD		-65		dBc	
CSO		-71		dBc	
CIN		61		dB	

1. The slope is defined as the difference between the gain at the start frequency and the gain at the stop frequency.
2. 79 analog channels, NTSC frequency raster: 55.25MHz to 547.25MHz, +43dBmV to +52.4dBmV tilted output level, plus 75 digital channels, -6dB offset relative to the equivalent analog carrier.
3. 79 analog channels, NTSC frequency raster: 55.25MHz to 547.25MHz, +43dBmV to +50.0dBmV tilted output level, plus 75 digital channels, -6dB offset relative to the equivalent analog carrier.
4. Composite Triple Beat (CTB) - The CTB parameter is defined by the NCTA.
Composite Second Order (CSO) - The CSO parameter (both sum and difference products) is defined by the NCTA.
Cross Modulation (XMOD) - Cross modulation (XMOD) is measured at baseband (selective voltmeter method), referenced to 100% modulation of the carrier being tested.
Carrier to Intermodulation Noise (CIN) - The CIN parameter is defined by ANSI/SCTE 17 (Test Procedure for carrier to noise).
5. Test condition: Pin 4 not connected

Current Adjustment Using Hybrid Pin 4

The RFPD2930 can be operated over a wide range of current to provide maximum required performance with minimum current consumption. A single external resistor connected between pin 4 and GND allows variation of current between 430mA and 220mA (typ.). Within the recommended range of current between 430mA and 370mA gain (S21) change is less than 0.2dB and noise figure change is less than 0.1dB. If pin 4 is not connected the devices operates at maximum current, see table below.

Examples of connecting pin 4:

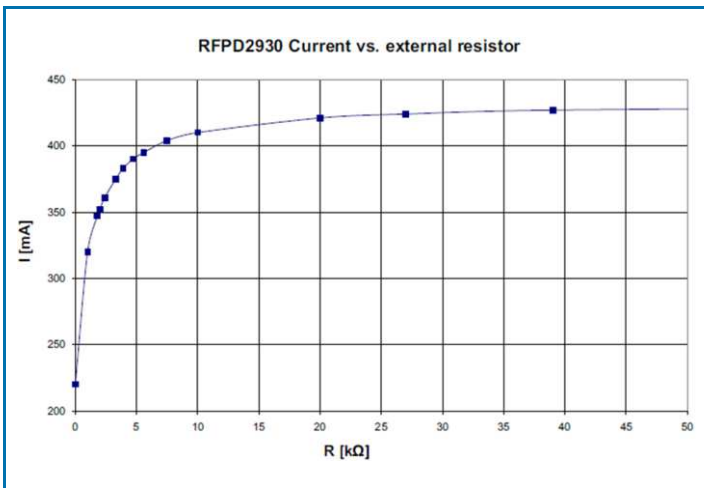
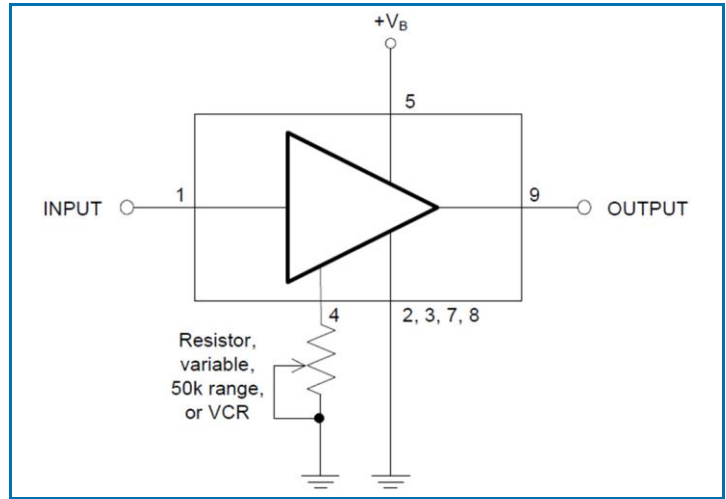
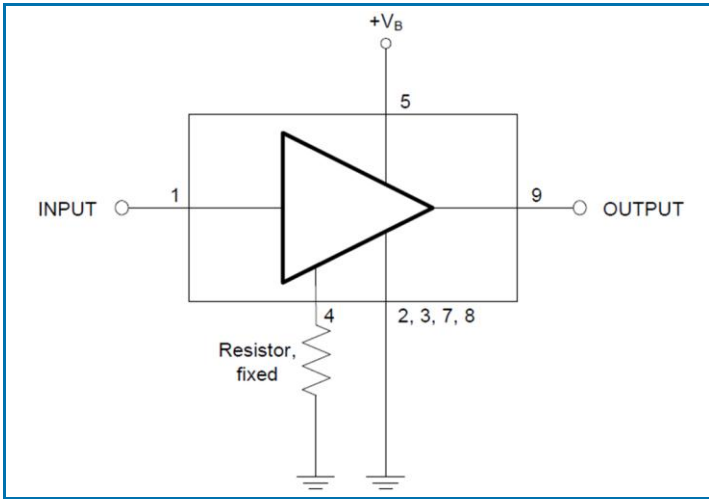

Device current [mA], typical	External resistor [Ω]
430	>50k (open)
420	18k
400	6k8
370	3k
340	1k8
320	1k
220	0 (short)

$V_+ = 24V$; $T_{MB} = 30^\circ C$;
 $Z_S = Z_L = 75\Omega$

Change of Distortion Performance Over Current

Test Condition: $V_+ = 24V$; $T_{MB} = 30^\circ C$; $Z_S = Z_L = 75\Omega$; 79 ch. 7dB tilted; $V_O = 50dBmV$ at 550MHz, plus 75 digital channels (-6dB offset)

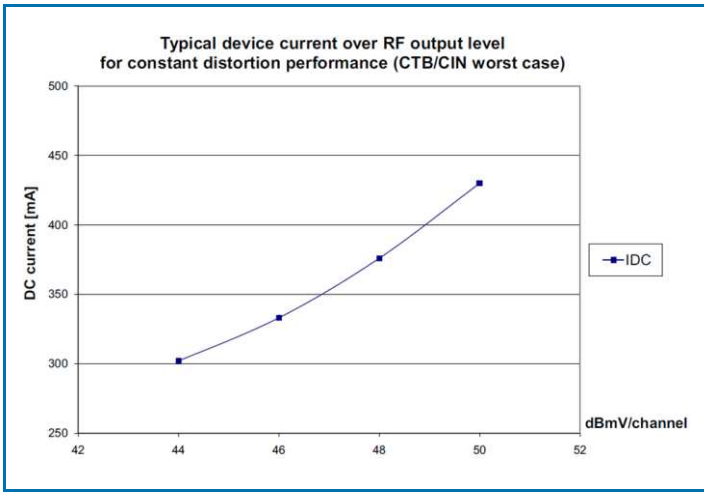
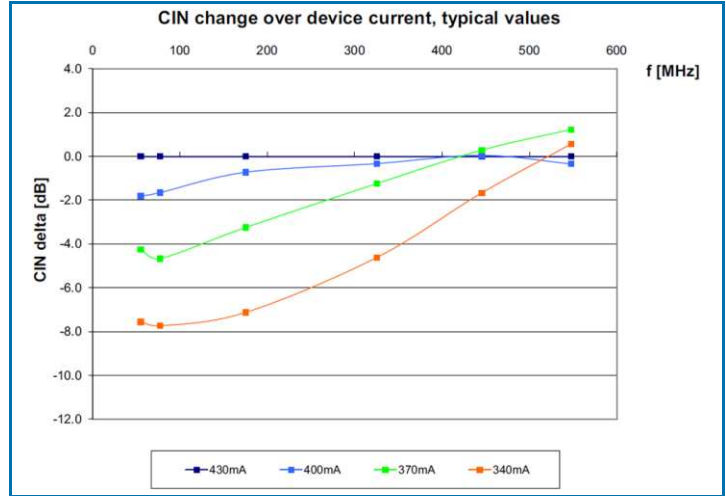
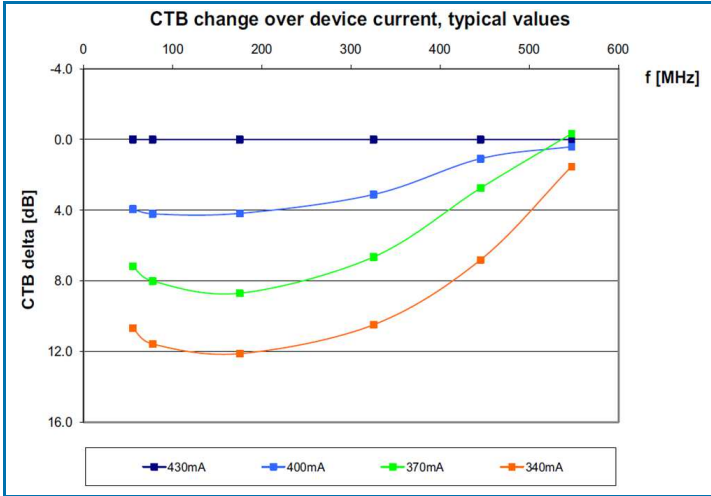

Package Drawing (Dimensions in millimeters)

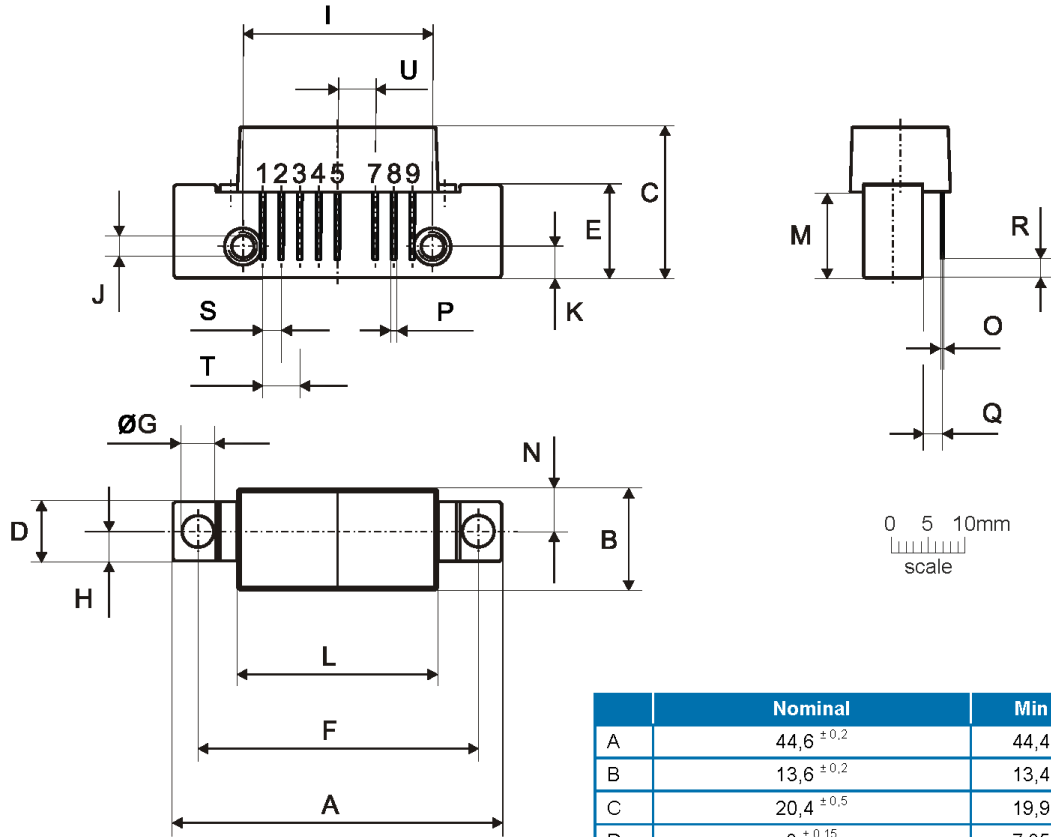

Notes:

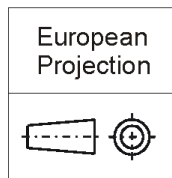

Pinning:

Pin	Name
1	Input
2-3	GND
4	IDC Adjustment
5	+VB
6	
7-8	GND
9	Output

	Nominal	Min	Max
A	44,6 ±0,2	44,4	44,8
B	13,6 ±0,2	13,4	13,8
C	20,4 ±0,5	19,9	20,9
D	8 ±0,15	7,85	8,15
E	12,6 ±0,15	12,45	12,75
F	38,1 ±0,2	37,9	38,3
G	4 +0,2 / -0,05	3,95	4,2
H	4 ±0,2	3,8	4,2
I	25,4 ±0,2	25,2	25,6
J	UNC 6-32	-	-
K	4,2 ±0,2	4,0	4,4
L	27,2 ±0,2	27,0	27,4
M	11,6 ±0,5	11,1	12,1
N	5,8 ±0,4	5,4	6,2
O	0,25 ±0,02	0,23	0,27
P	0,45 ±0,03	0,42	0,48
Q	2,54 ±0,3	2,24	2,84
R	2,54 ±0,5	2,04	3,04
S	2,54 ±0,25	2,29	2,79
T	5,08 ±0,25	4,83	5,33
U	5,08 ±0,25	4,83	5,33