



Chipsmall Limited consists of a professional team with an average of over 10 year of expertise in the distribution of electronic components. Based in Hongkong, we have already established firm and mutual-benefit business relationships with customers from,Europe,America and south Asia,supplying obsolete and hard-to-find components to meet their specific needs.

With the principle of “Quality Parts,Customers Priority,Honest Operation,and Considerate Service”,our business mainly focus on the distribution of electronic components. Line cards we deal with include Microchip,ALPS,ROHM,Xilinx,Pulse,ON,Everlight and Freescale. Main products comprise IC,Modules,Potentiometer,IC Socket,Relay,Connector.Our parts cover such applications as commercial,industrial, and automotives areas.

We are looking forward to setting up business relationship with you and hope to provide you with the best service and solution. Let us make a better world for our industry!



Contact us

Tel: +86-755-8981 8866 Fax: +86-755-8427 6832

Email & Skype: info@chipsmall.com Web: www.chipsmall.com

Address: A1208, Overseas Decoration Building, #122 Zhenhua RD., Futian, Shenzhen, China



Solid State Relays 1-Phase with Integrated Heatsink Zero Cross or Instant On Switching Types RGC Solid State Contactor 'E' Connection



- Product width ranging from 17.5mm up to 70mm
- Rated operational voltage: up to 660 VAC
- Rated operational current: up to 85 AAC @ 40°C
- 18000 A²s for the I²t and 1200 Vp blocking voltage
- Control voltages: 3-32 VDC, 20-275 VAC (24-190 VDC)
- Design according to EN/IEC60947-4-2, EN/IEC60947-4-3, EN/IEC62314, UL508, CSA 22-2 No. 14-13
- Integrated voltage transient protection with varistor
- 100 kA short circuit current rating according to UL508



Product Description

This new range of solid state contactors presents a unique opportunity to maximize efficiency in panel space and is an evolution of solid state switches for which Carlo Gavazzi is very well known.

The nominal current ratings are at 40°C. The smallest

width is 17.5mm and is rated at 37 AAC. Power and control terminals allow for safe looping of cables.

Voltage transient protection is standard across the output with a varistor. Specifications are stated at 25°C unless otherwise noted.

1. RGC..32 models are not VDE approved

2. Germanischer Lloyd approval applicable only to models RGC1...15.KE, RGC1...20.KE, RGC1...25..KE and RGC1...30.KE

3. EAC is not applicable to RGC..P models

Ordering Key **RGC 1 A 60 A 30 K K E**

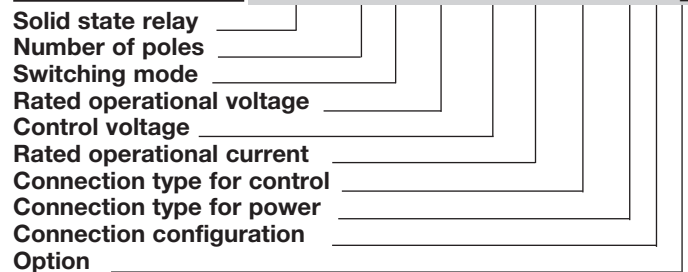

Ordering Key (Refer to page 2 and 3 for available part numbers)

1Phase SSR with heatsink	Rated voltage, Blocking voltage	Control voltage	Rated current at 40°C ⁴	Connection control	Connection power	Connection configuration	Option
RGC1A: ZC⁵	23: 230V +10% - 15%, 800Vp	D: 3 or 4-32VDC	15: 20AAC, 525A ² s	K: Screw	K: Screw	E: Contactor	P: Overtemperature protection (OTP) ⁶
RGC1B: IO⁵	60: 600V +10% -15%, 1200Vp	A: 20 - 275VAC, 24-190 VDC	20: 23AAC, 525A ² s 25: 25AAC, 1800A ² s 30: 30AAC, 1800A ² s 32: 30 AAC, 18000A ² s 37: 37 AAC, 18000A ² s 40: 40AAC, 3200A ² s 42: 43AAC, 18000A ² s 60: 60AAC, 3200A ² s 62: 65AAC, 18000A ² s 90: 85AAC, 6600A ² s 92: 85AAC, 18000A ² s	G: Box clamp M: Pluggable spring-loaded	G: Box clamp		

4. Refer to Derating Curves

5. ZC = Zero cross switching, IO= Instant ON switching

6. Default control connection for RGC...P is Box Clamp. See Connections Specifications

Selection Guide

Rated voltage, Blocking voltage, Switching mode	Control voltage	Connection control/power	Rated operational current @ 40°C (I ² t value)				
			Product width				
			20 AAC (525A ² s) 17.5mm, low depth	23 AAC (525A ² s) 17.5mm	25 AAC (1800A ² s) 17.5mm, low depth	30 AAC (1800A ² s) 22.5mm	
230V, 800Vp ZC	3-32VDC	Screw/Screw	RGC1A23D15KKE	RGC1A23D20KKE	RGC1A23D25KKE	RGC1A23D30KKE	
		Spring/Screw	RGC1A23D15MKE	RGC1A23D20MKE	RGC1A23D25MKE	RGC1A23D30MKE	
	20-275VAC, 24-190VDC	Screw/Screw	RGC1A23A15KKE	RGC1A23A20KKE	RGC1A23A25KKE	RGC1A23A30KKE	
		Spring/Screw	RGC1A23A15MKE	RGC1A23A20MKE	RGC1A23A25MKE	RGC1A23A30MKE	
				40 AAC (3200A²s) 35mm	43 AAC (18000A²s) 35mm	60 AAC (3200A²s) 70mm	65 AAC (18000A²s) 70mm
	3-32VDC	Screw/Box	RGC1A23D40KGE	RGC1A23D42KGE	RGC1A23D60KGE	RGC1A23D62KGE	
20-275VAC, 24-190VDC	Screw/Box	RGC1A23A40KGE	RGC1A23A42KGE	RGC1A23A60KGE	RGC1A23A62KGE		
			20 AAC (525A ² s) 17.5mm, low depth	23 AAC (525A ² s) 17.5mm	25 AAC (1800A ² s) 17.5mm, low depth	30 AAC (1800A ² s) 22.5mm	
600V, 1200Vp ZC	4-32VDC	Screw/Screw	RGC1A60D15KKE	RGC1A60D20KKE	RGC1A60D25KKE	RGC1A60D30KKE	
		Spring/Screw	RGC1A60D15MKE	RGC1A60D20MKE	RGC1A60D25MKE	RGC1A60D30MKE	
	20-275VAC, 24-190VDC	Screw/Screw	RGC1A60A15KKE	RGC1A60A20KKE	RGC1A60A25KKE	RGC1A60A30KKE	
		Spring/Screw	RGC1A60A15MKE	RGC1A60A20MKE	RGC1A60A25MKE	RGC1A60A30MKE	
				30 AAC (18000A²s) 17.5mm, low depth	37 AAC (18000A²s) 17.5mm, low depth		
	4-32VDC	Screw/Screw	RGC1A60D32KKE	-			
		Spring/Screw	RGC1A60D32MKE	-			
		Screw/Box	-	RGC1A60D32KGE			
		Spring/Box	-	RGC1A60D32MGE			
				40 AAC (3200A²s) 35mm	43 AAC (18000A²s) 35mm	60 AAC (3200A²s) 70mm	65 AAC (18000A²s) 70mm
	4-32VDC	Screw/Box	RGC1A60D40KGE	RGC1A60D42KGE	RGC1A60D60KGE	RGC1A60D62KGE	
		Spring/Box	RGC1A60D40MGE	RGC1A60D42MGE	-	RGC1A60D62MGE	
20-275VAC, 24-190VDC	Screw/Box	RGC1A60A40KGE	RGC1A60A42KGE	RGC1A60A60KGE	RGC1A60A62KGE		
	Spring/Box	RGC1A60A40MGE	RGC1A60A42MGE	-	RGC1A60A62MGE		
			20 AAC (525A ² s) 17.5mm, low depth	23 AAC (525A ² s) 17.5mm	25 AAC (1800A ² s) 17.5mm, low depth	30 AAC (1800A ² s) 22.5mm	
600V, 1200Vp IO	4-32VDC	Screw/Screw	RGC1B60D15KKE	RGC1B60D20KKE	RGC1B60D25KKE	RGC1B60D30KKE	
					40 AAC (3200A²s) 35mm	43 AAC (18000A²s) 35mm	60 AAC (3200A²s) 70mm
	4-32VDC	Screw/Box	RGC1B60D40KGE	RGC1B60D42KGE	RGC1B60D60KGE	RGC1B60D62KGE	

Selection Guide - RGC..P (Integrated Overtemperature Protection)

Rated voltage, Blocking voltage, Switching mode	Control voltage	Connection control / power	Rated operational current @ 40°C (I ² t value)			
			Product width			
600V, 1200Vp ZC	5-32VDC 20-275VAC, 24-190VDC	Box/Screw Box/Screw	30 AAC (1800A²s) 22.5mm			
			RGC1A60D30GKEP			
			43 AAC (18000A²s) 35mm	65AAC (18000A²s) 70mm	85AAC (6600A²s) 70mm + fan	85AAC (18000A²s) 70mm + fan
	5-32VDC	Box/Box	RGC1A60D42GGEP	RGC1A60D62GGEP	RGC1A60D90GGEP	RGC1A60D92GGEP
	20-275VAC, 24-190VDC	Box/Box	RGC1A60A42GGEP	RGC1A60A62GGEP	RGC1A60A90GGEP	RGC1A60A92GGEP

Output Voltage Specifications

	RGC..23..	RGC..60..
Operational voltage range	24-240 VAC, +10%, -15% on max	42-600 VAC, +10% -15% on max
Blocking voltage	800Vp	1200 Vp
Internal varistor	275V	625V

General Specifications

Latching voltage (across L1-T1)	20V	Rated impulse withstand	6 kV (1.2/50µs) for voltage, U _{imp}
Operational frequency range	45 to 65Hz	Over-voltage category	III (fixed installations)
Power factor	> 0.5 @ V _{rated}	Isolation	
Touch Protection	IP20	Input to Output	RGC... 4000 Vrms RGC...D..P 2500 Vrms RGC...A..P 4000 Vrms
Control input status	continuously ON Green LED, when control input is applied	Input and Output to case	RGC... 4000 Vrms RGC...D..P 4000 Vrms RGC...A..P 4000 Vrms
Pollution degree	2 (non-conductive pollution with possibilities of condensation)	Input to Fan/ Alarm Output	RGC...A..P 2500 Vrms

Output Specifications

	RGC..15..	RGC..20..	RGC..25..	RGC..30..	RGC..32..KE	RGC..32..GE
Rated operational current ⁷						
AC-51 rating @ Ta=25°C	20 AAC	25.5 AAC	30 AAC	30 AAC	30 AAC	43 AAC
AC-51 rating @ Ta=40°C	20 AAC	23 AAC	25 AAC	30 AAC	30 AAC	37 AAC
AC-53a rating @ Ta=40°C	5 AAC	5 AAC	5 AAC	8 AAC	5 AAC	5 AAC
Number of motor starts per hour (x:6, Tx:6s, F:50%) at 40°C ⁸	30	30	30	30	30	30
Min. operational current	150 mAAC	150 mAAC	250 mAAC	250 mAAC	500 mAAC	500 mAAC
Rep. overload current - (Motor Rating) PF = 0.4 - 0.5 UL508: T _{AMB} =40°C, t _{ON} =1s, t _{OFF} =9s, 50cycles	51 AAC	60 AAC	51 AAC	84 AAC	51 AAC	51 AAC
Maximum transient surge current (I _{TSM}), t=10ms	325 Ap	325 Ap	600 Ap	600 Ap	1900 Ap	1900 Ap
Maximum off-state leakage current at rated voltage	3 mAAC	3 mAAC	3 mAAC	3 mAAC	3 mAAC	3 mAAC
I ² t for fusing (t=10ms), Minimum	525 A ² s	525 A ² s	1800 A ² s	1800 A ² s	18000 A ² s	18000 A ² s
Critical dv/dt (@ T _j init = 40°C)	1000 V/μs	1000 V/μs	1000 V/μs	1000 V/μs	1000 V/μs	1000 V/μs

	RGC..40..	RGC..42..	RGC..60..	RGC..62..	RGC..90..	RGC..92..
Rated operational current ⁷						
AC-51 rating @ Ta=25°C	47 AAC	50 AAC	70 AAC	75 AAC	85 AAC	85 AAC
AC-51 rating @ Ta=40°C	40 AAC	43 AAC	60 AAC	65 AAC	85 AAC	85 AAC
AC-53a rating @ Ta=40°C	13 AAC	16 AAC	14.8 AAC	20 AAC	18 AAC	20 AAC
Number of motor starts per hour (x:6, Tx:6s, F:50%) at 40°C ⁸	30	30	30	30	30	30
Min. operational current	400 mAAC	500 mAAC	400 mAAC	500 mAAC	400 mAAC	500 mAAC
Rep. overload current - (Motor Rating) PF = 0.4 - 0.5 UL508: T _{AMB} =40°C, t _{ON} =1s, t _{OFF} =9s, 50cycles	126 AAC	126 AAC	126 AAC	168 AAC	168 ACC	168 AAC
Maximum transient surge current (I _{TSM}), t=10ms	800 Ap	1900 Ap	800 Ap	1900 Ap	1150 Ap	1900 Ap
Maximum off-state leakage current at rated voltage	3 mAAC	3 mAAC	3 mAAC	3 mAAC	3 mAAC	3 mAAC
I ² t for fusing (t=10ms), Minimum	3200 A ² s	18000 A ² s	3200 A ² s	18000 A ² s	6600 A ² s	18000 A ² s
Critical dv/dt (@ T _j init = 40°C)	1000 V/μs	1000 V/μs	1000 V/μs	1000 V/μs	1000 V/μs	1000 V/μs

7. See Derating Curves

8. Overload profile for AC-53a;

le: AC-53a: x-Tx: F-S, where I_e = nominal current (AC-53a AAC), x = overload current factor, Tx = duration of overload current (s), F = duty cycle (%), S = number of starts per hour. Example; 5A: AC-53a: 6 - 6 : 50 - 30 = max. 30 starts for the RGC..15 with an overload profile of 30A for 6 seconds with a duty cycle of 50%

Overtemperature Alarm Specifications for RGC...P

	RGC..D..P	RGC..A..P
Output type	PNP open collector	Potential Free
Normal state	Closed	Closed
Maximum current rating	50 mADC	50 mADC
Rated voltage (EN61131-2: 2003) ^{9, 10} , U _a	24VDC -15%, +20%	24VDC -15%, +20%
Rated voltage, U _s	RGC...D9xGGEP 24VDC ± 10%	N/A
Fan rating, U _f	RGC...A9xGGEP N/A	24VDC ±10%, 50mA nominal
Alarm voltage drop	Typical Maximum 2.8VDC 4VDC	1.8VDC 3.5VDC
Visual Indication	Continuous Red LED	Continuous Red LED
Reverse polarity protection	24VDC	24VDC

9. DC supply for alarm signal should be supplied from a Class 2 power source

10. Maximum voltage to be applied between 11+ and 12- (U_a) terminals should be 35VDC maximum with reference to A2-

Input Specifications

		RGC..D..	RGC..A..
Control voltage range ^{11,12}	RGC..23..	3 - 32 VDC	20 - 275 VAC, 24 (-10%) - 190 VDC
	RGC..60..	4 - 32 VDC	20-275 VAC, 24 (-10%) - 190 VDC
	RGC...P (Uc)	5 - 32 VDC	20-275 VAC, 24 (-10%) - 190 VDC
Pick-up voltage	RGC..23..	3.0 VDC	20 VAC/DC
	RGC..60..	3.8 VDC	
	RGC...P	5 VDC	20 VAC/ 24VDC
Drop-out voltage		1 VDC	5 VAC/DC
Maximum Reverse voltage		32 VDC	-
Response time pick-up (RGC1A..)		0.5 cycle + 500µs @ 24VDC	2 cycles @ 230VAC/110VDC
Response time pick-up (RGC1B..)		350µs @ 24 VDC	N/A
Response time drop-out		0.5 cycle + 500µs @ 24VDC	0.5 cycle + 40ms @ 230VAC/110VDC
Input current @ 40°C		See diagrams below	See diagrams below

11. DC control to be supplied by class 2 power source according to UL1310

12. For GL approved models control range for RGC1.23... is 4-32VDC and for RGC1.60... 5-32VDC

RG..A..

RGC1 .. A : Input current vs input voltage

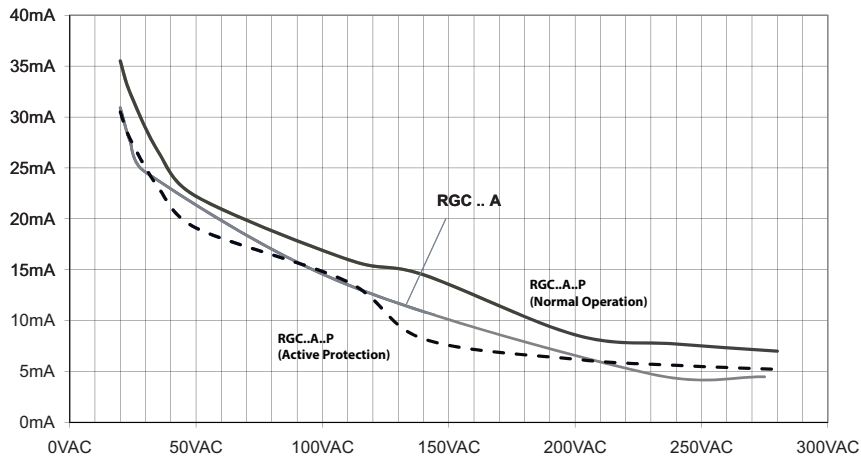

RGC1 .. A : Input current vs input voltage

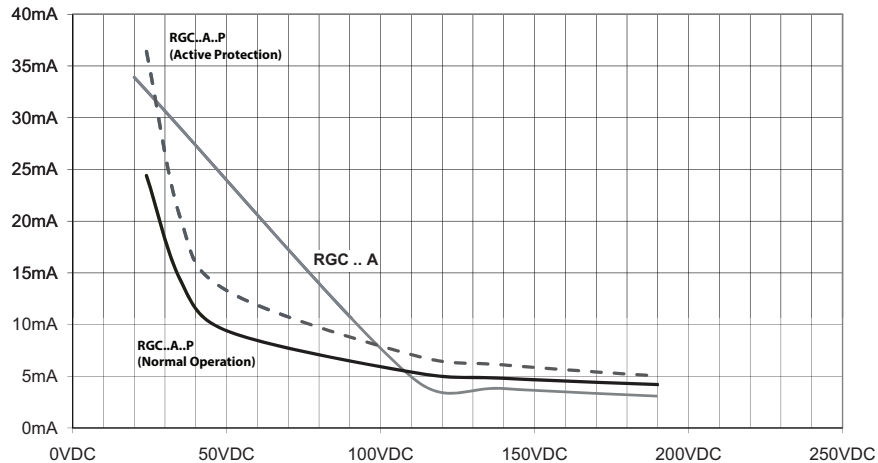

Input Specifications (cont.)

RG..D..

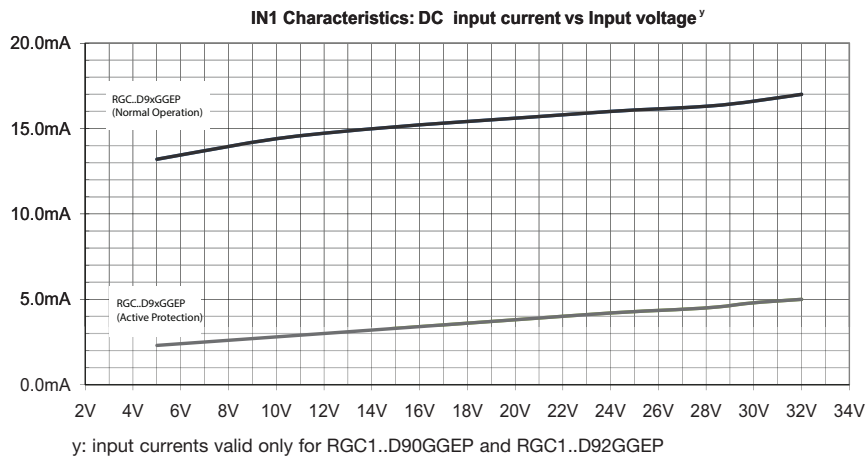
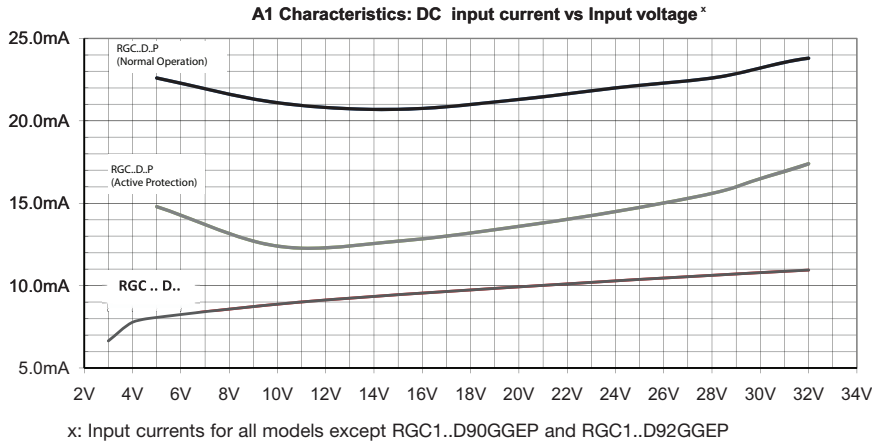

Motor Ratings: HP (UL508) / kW (EN/IEC60947-4-2) @ 40°C

	115 VAC	230 VAC	400 VAC	480 VAC	600 VAC
RGC..15	1/3HP / 0.18kW	1HP / 0.37kW	2HP / 0.75kW	3HP / 1.1kW	3HP / 1.5kW
RGC..20	1/2HP / 0.18kW	1 1/2HP / 0.37kW	2HP / 0.75kW	3HP / 1.1kW	3HP / 1.5kW
RGC..25	1/3HP / 0.18kW	1HP / 0.37kW	2HP / 0.75kW	3HP / 1.1kW	3HP / 1.5kW
RGC..30	3/4HP / 0.37kW	2HP / 1.1kW	3HP / 1.5kW	5HP / 2.2kW	5HP / 3.7kW
RGC..32	1/3HP / 0.18kW	1HP / 0.37kW	2HP / 0.75kW	3HP / 1.1kW	3HP / 1.5kW
RGC..40	1HP / 0.56kW	3HP / 1.5kW	5HP / 2.2kW	5HP / 3.7kW	7 1/2HP / 4kW
RGC..42	1 1/2HP / 0.56kW	3HP / 1.5kW	5HP / 2.2kW	7 1/2HP / 3.7kW	10HP / 4kW
RGC..60	1 1/2HP / 0.56kW	3HP / 1.5kW	5HP / 3kW	7 1/2HP / 4kW	10HP / 4kW
RGC..62	2HP / 0.75kW	5HP / 1.5kW	7 1/2HP / 4kW	10HP / 4kW	15HP / 5.5kW
RGC..90	2HP / 0.75kW	5HP / 1.5kW	7 1/2HP / 4kW	10HP / 4kW	15HP / 5.5kW
RGC..92	2HP / 0.75kW	5HP / 1.5kW	7 1/2HP / 4kW	10HP / 4kW	15HP / 5.5kW

Detailed Over temperature Alarm Procedure (for RGC...P)

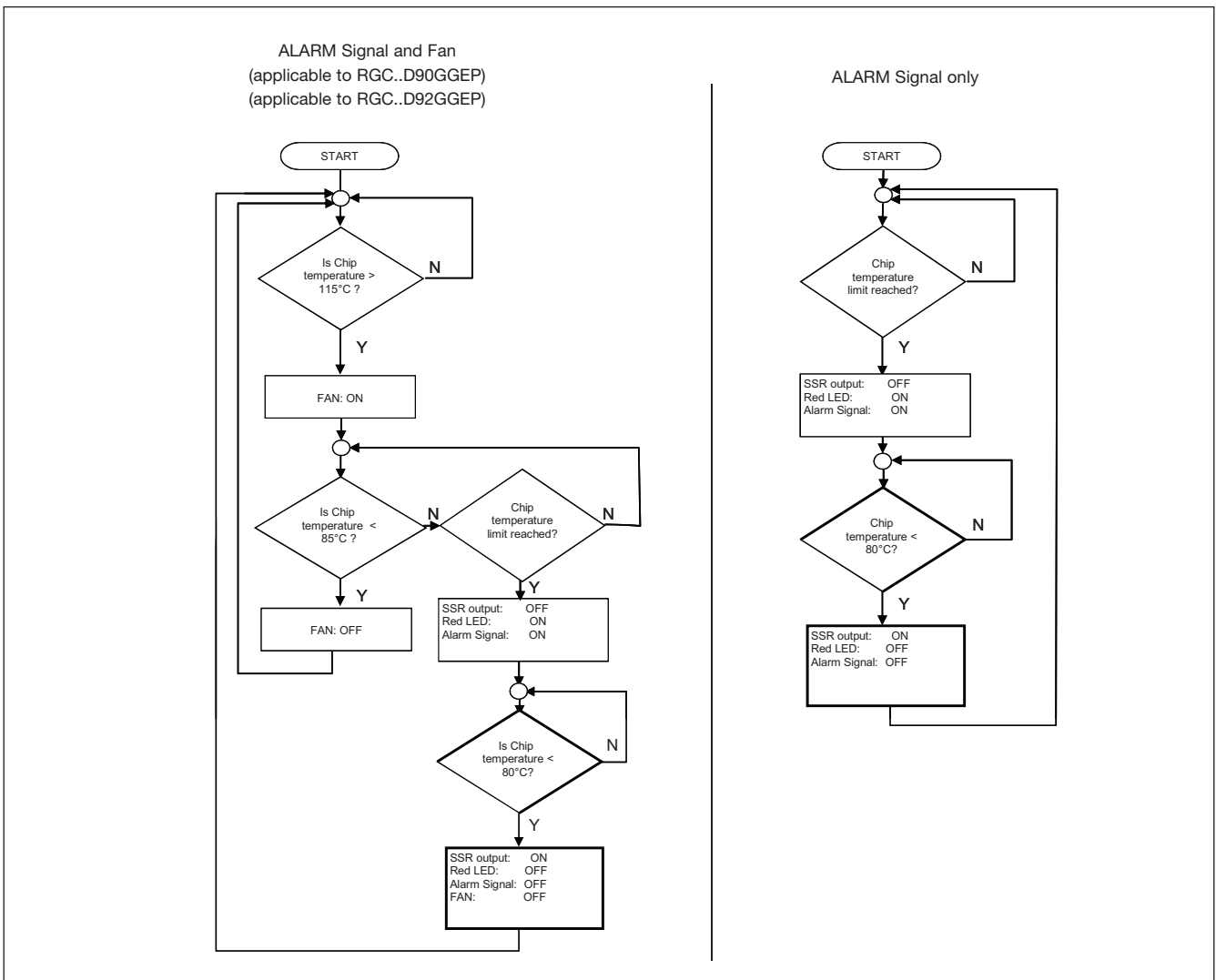

CAUTION

- Alarm condition resets whenever the voltage signal is removed from terminal A1 (+)
- In the case of RGC1A60D9xGGEP, if the voltage signal is not applied across A1(+) and A2 (-) terminals, the overtemperature detection and functionality is lost (including fan operation and alarm signalling)
- In the case of RGC1A60A9xGGEP it is necessary to supply IN2 and IN3 with 24VDC for fan operation.
- Alarm procedure for RGC1A60A9xGGEP follows 'Alarm signal only' flow since fan is continuously operating.
- Alarm condition automatically resets ONLY when power semiconductor temperature < 80°C
- Temperatures indicated are typical figures.

Output Power Dissipation

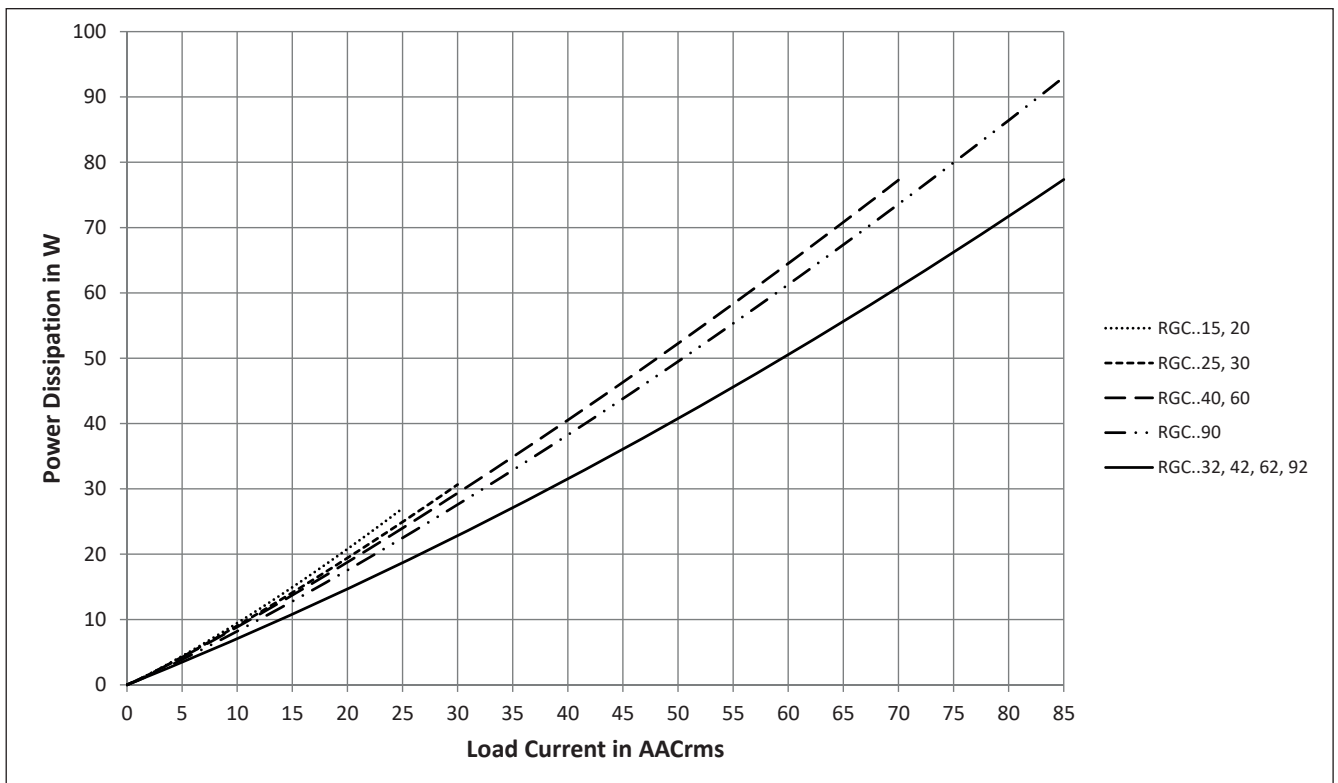

Current Derating (UL508)

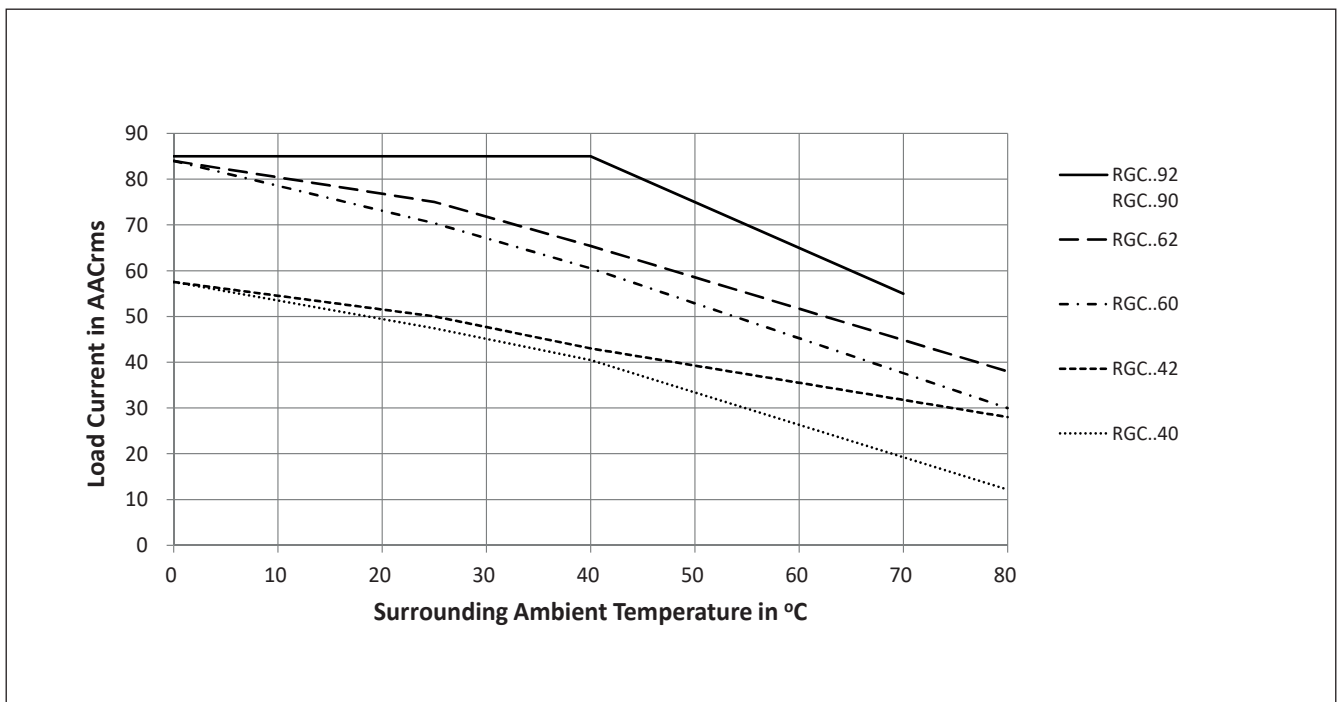
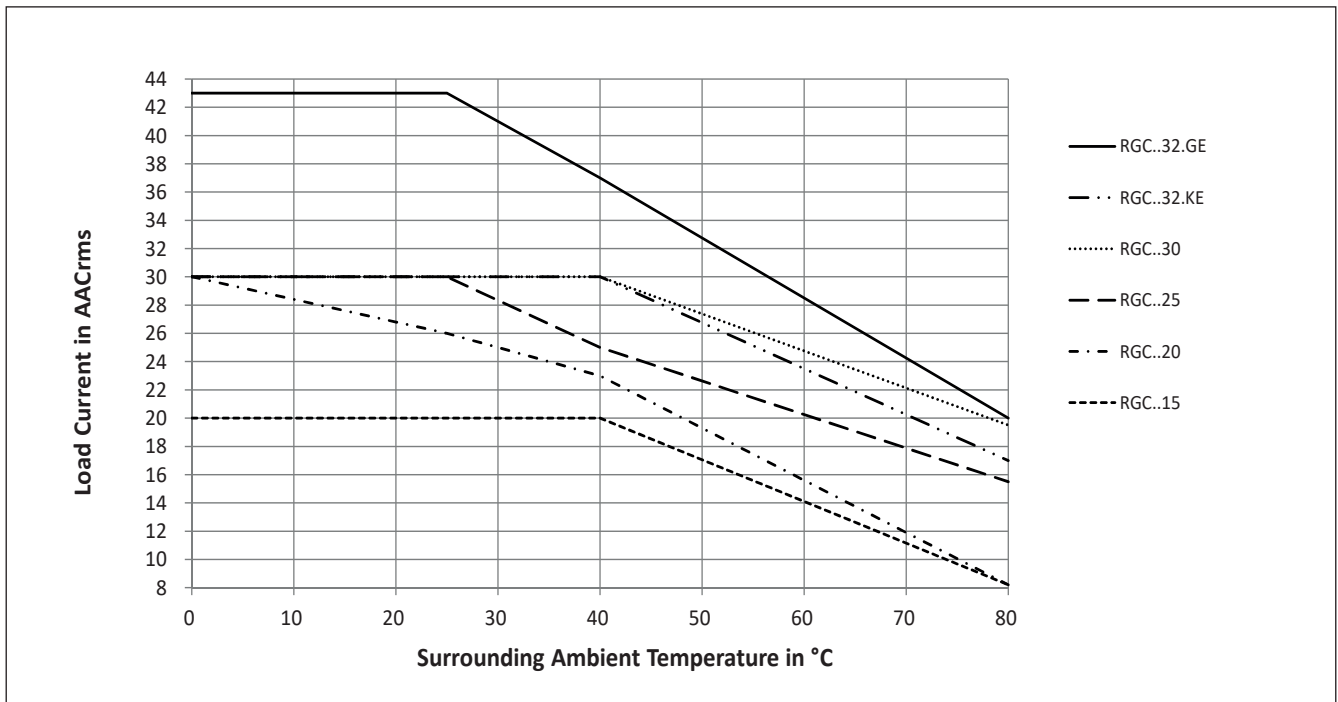

RGC...P models max. operating temperature is + 70°C

Derating vs. Spacing Curves

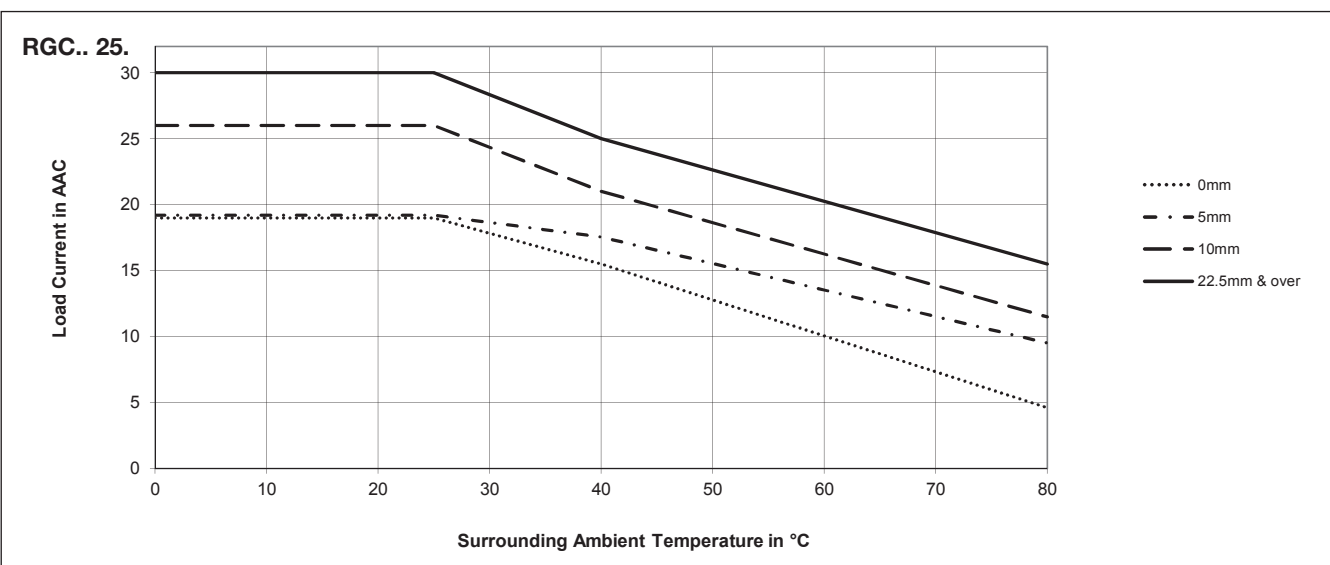
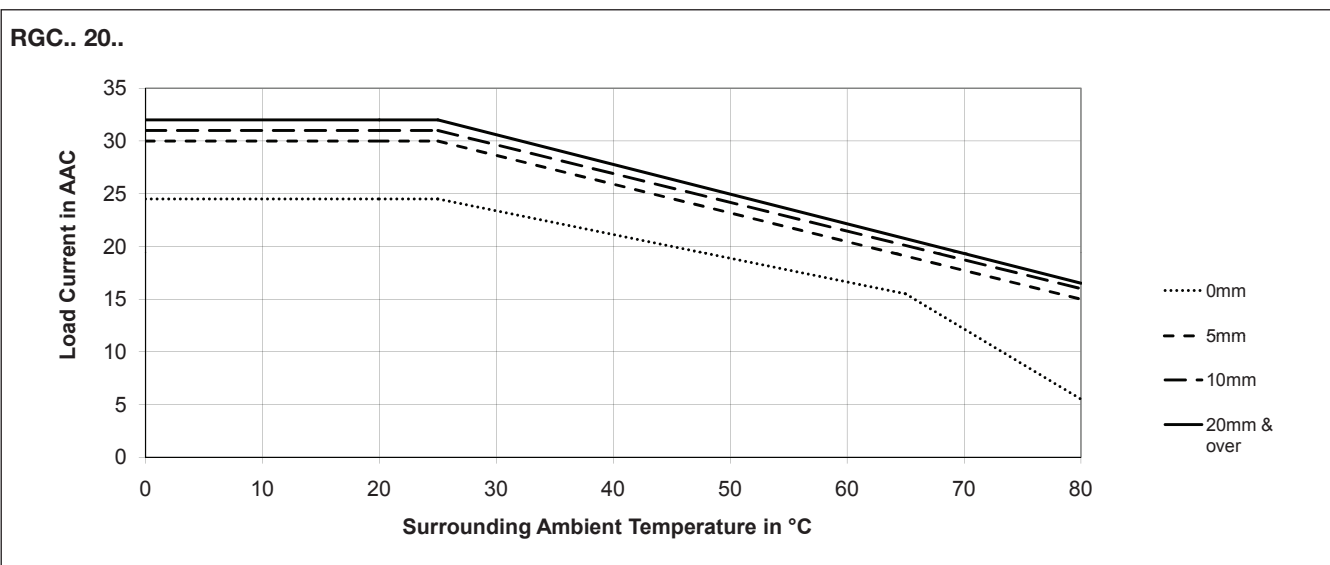
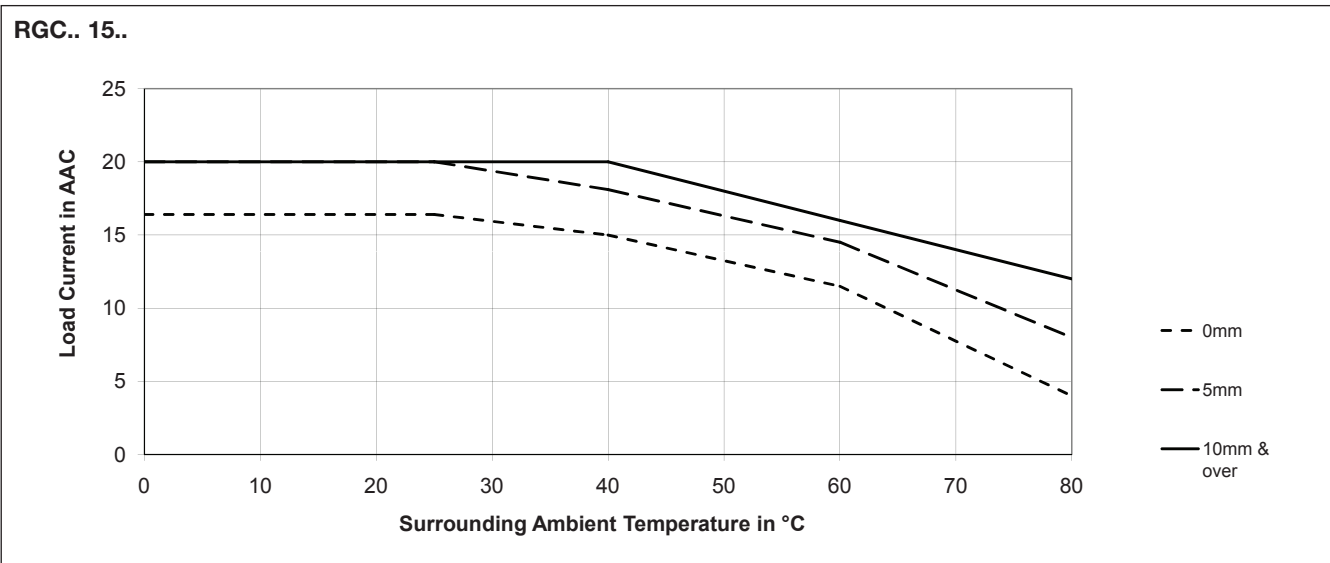

Derating vs. Spacing Curves

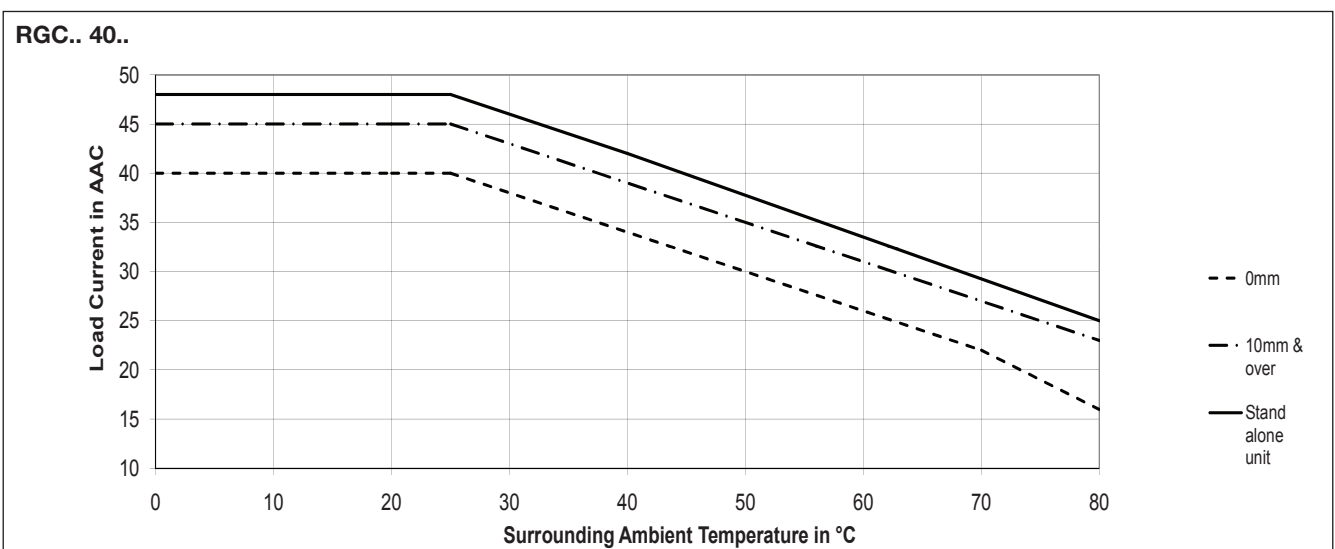
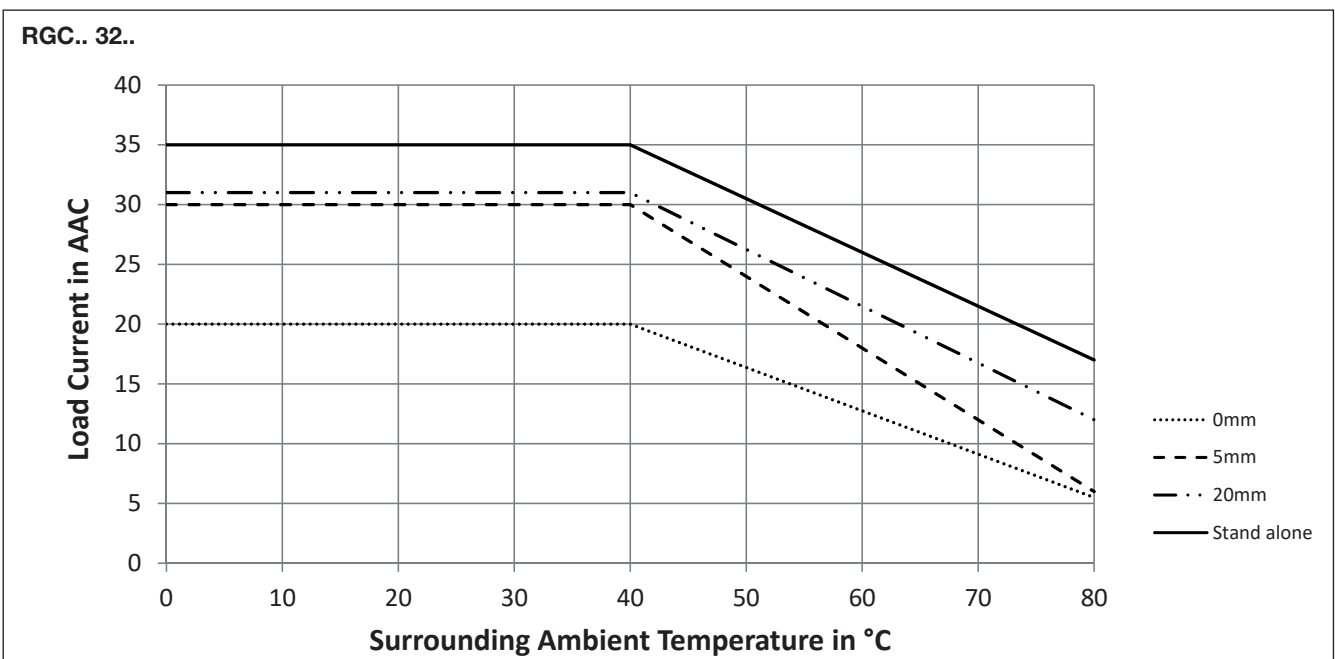
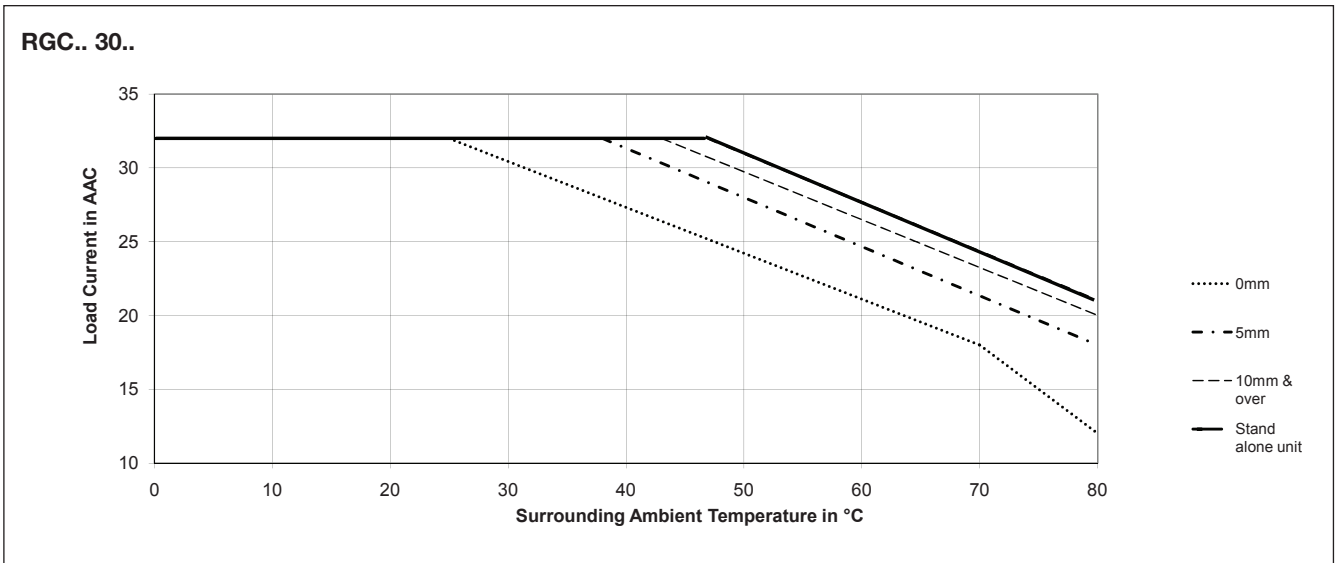

Derating vs. Spacing Curves

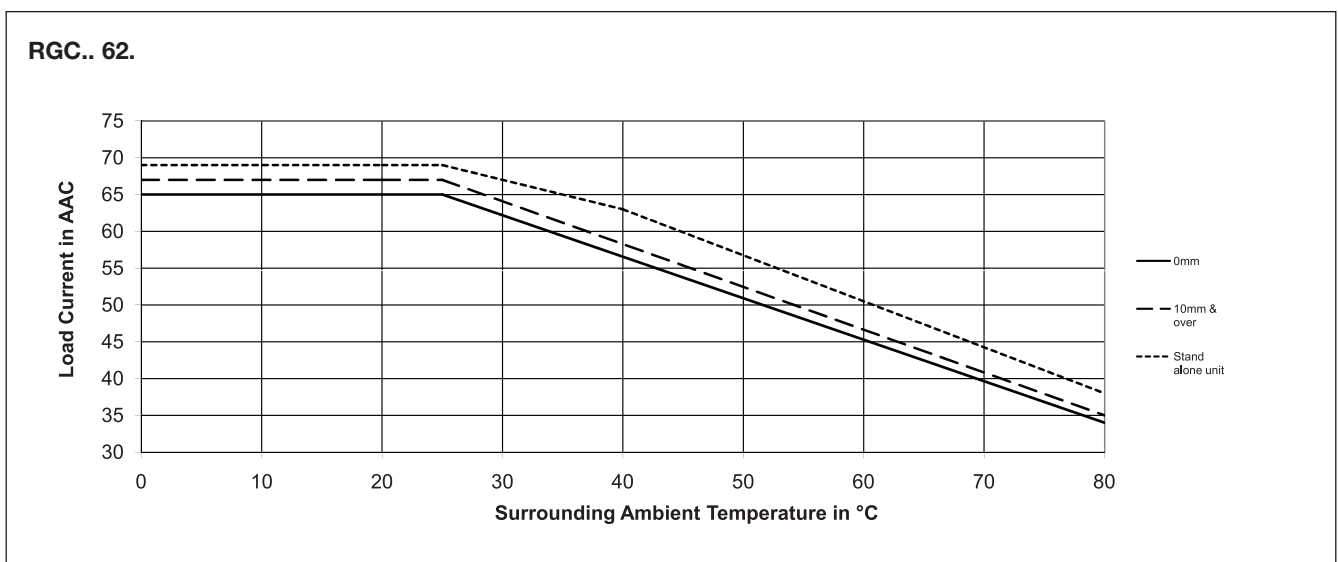
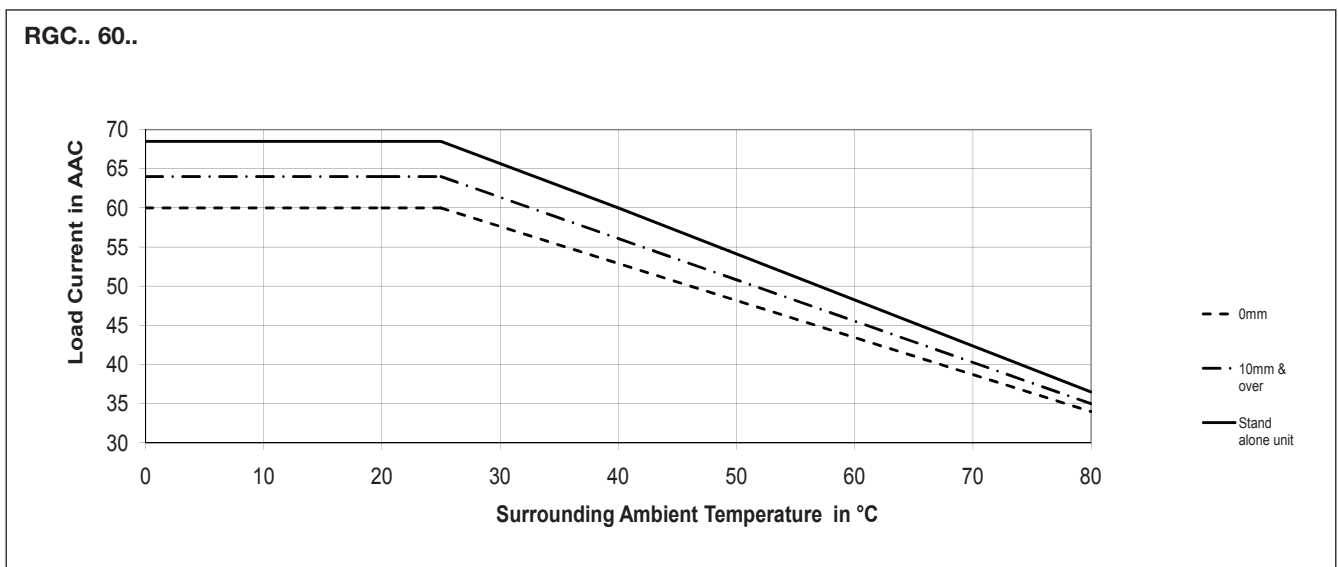
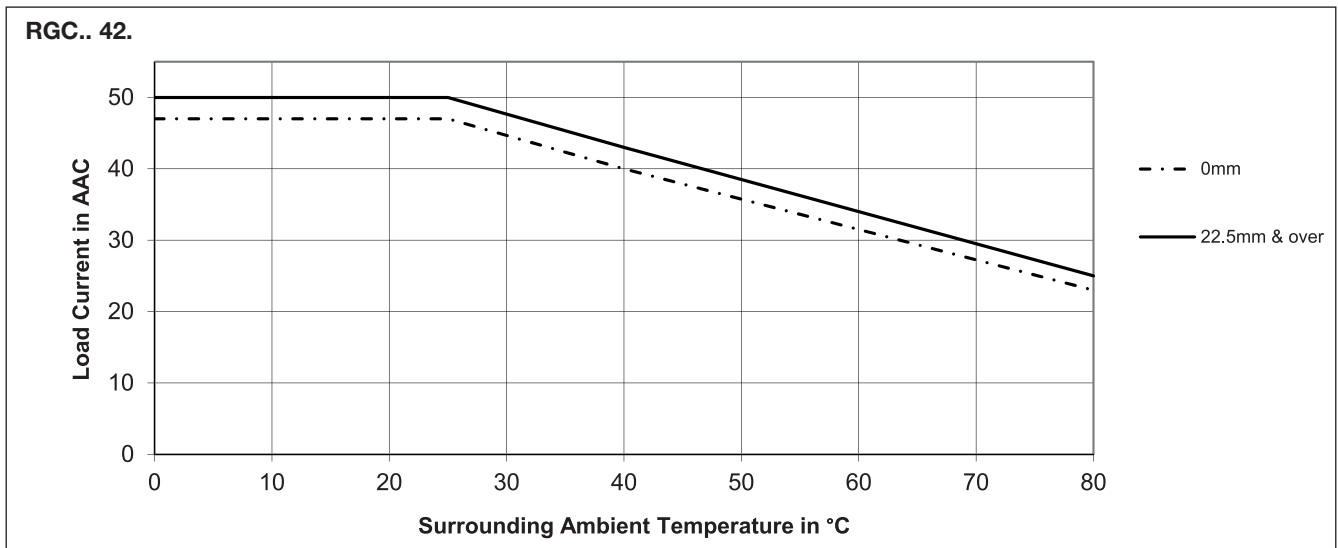

Derating vs. Spacing Curves

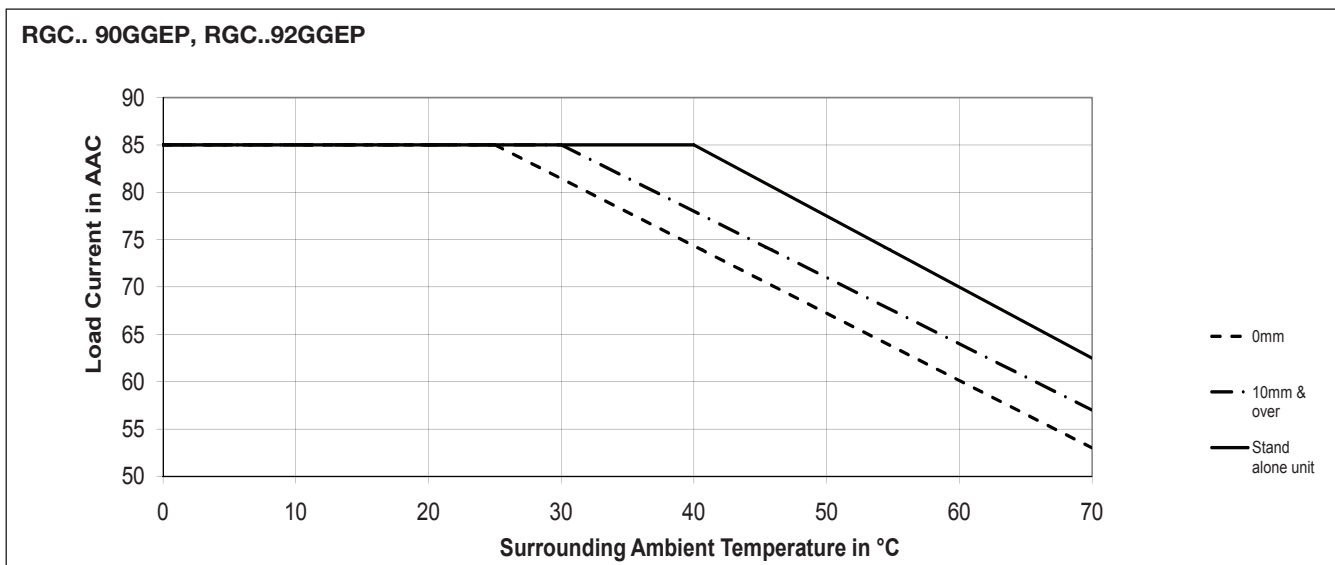

Environmental Specifications

Operating temperature ¹³	-40°C to 80°C (-40°F to +176°F)	Vibration resistance (2-100Hz, IEC60068-2-6, EN50155, EN61373)	2g per axis
Storage temperature	-40°C to 100°C (-40°F to +212°F)	Relative humidity	95% non-condensing @ 40°C
EU RoHS compliant	Yes	UL flammability rating (housing)	UL 94 V0 Glow wire ignition temperature and Glow wire flammability index conform to EN 60335-1 requirements
China RoHS compliant	Refer to Environmental Information (page 29)	Impact resistance (EN50155, EN61373)	15/11 g/ms
Weight			
RGC..15	approx. 260g	RGC..30 (P)	approx. 375g (412g)
RGC..20	approx. 315g	RGC..4x (P)	approx. 515g (581g)
RGC..25	approx. 260g	RGC..6x (P)	approx. 972g (1020g)
RGC..32	approx. 260g	RGC..9x P	approx. 1100g
RGC..32..GE	approx. 269g		

Agency Approvals and Conformances

Conformance	IEC/EN 62314 IEC/EN 60947-4-2 IEC/EN 60947-4-3	Agency Approvals	UL508 Listed (E172877) cUL Listed (E172877) VDE 0660-109 ¹⁵ GL ¹⁴
		Short Circuit Current Rating	100kA, UL508



13. Operating temperature range for RGC..P (overtemperature protection) is -30°C to 70°C (-22°F to 158°F)

14. Applicable to models RGC1...15.KE, RGC1...20.KE, RGC1...25..KE and RGC1...30.KE

15. RGC..32 models are not VDE approved

16. EAC is not applicable to RGC..P models

Electromagnetic Compatibility

EMC Immunity	EN 60947-4-3	Electrical Surge Immunity (for RGC...EP)	IEC/EN 61000-4-5
Electrostatic Discharge (ESD) Immunity Air discharge, 8kV Contact, 4kV	IEC/EN 61000-4-2 Performance Criteria 1 Performance Criteria 1	Output, line to line, 1kV Output, line to earth, 2kV DC lines, line to line, 500V DC lines, line to earth, 500V Signal lines, line to earth, 1kV	Performance Criteria 1 Performance Criteria 1 Performance Criteria 2 Performance Criteria 2 Performance Criteria 2
Electrical Fast Transient (Burst) Immunity Output: 2kV, 5kHz Input: 1kV, 5kHz	IEC/EN 61000-4-4 Performance Criteria 1 Performance Criteria 1	Radiated Radio Frequency Immunity 10V/m, 80 - 1000 MHz 10V/m, 1.4 - 2 GHz 3V/m, 2 - 2.7 GHz	IEC/EN 61000-4-3 Performance Criteria 1 Performance Criteria 1 Performance Criteria 1
Electrical Surge Immunity (for RGC...E) Output, line to line, 1kV Output, line to earth, 2kV Input, line to line, 1kV Input, line to earth, 2kV	IEC/EN 61000-4-5 Performance Criteria 1 Performance Criteria 1 Performance Criteria 2 Performance Criteria 2	Conducted Radio Frequency Immunity 10V/m, 0.15 - 80 MHz	IEC/EN 61000-4-6 Performance Criteria 1
		Voltage Dips Immunity 0% for 0.5, 1 cycle 40% for 10 cycles 70% for 25 cycles 80% for 250 cycles	IEC/EN 61000-4-11 Performance Criteria 2 Performance Criteria 2 Performance Criteria 2 Performance Criteria 2
		Voltage Interruptions Immunity 0% for 5000ms	IEC/EN 61000-4-11 Performance Criteria 2
EMC Emission	EN 60947-4-3	Radio Interference Field Emission (Radiated) 30 - 1000MHz	IEC/EN 55011 Class A (industrial)
Radio Interference Voltage Emission (Conducted) 0.15 - 30MHz	IEC/EN 55011 Class A (industrial) with filters - see filter information		

Filtering - EN / IEC 55011 Class A compliance (for class B compliance contact us)

Part Number	Suggested filter for compliance	Maximum Heater current
RGC1A23..15	68nF / 275 V / X1	20A
RGC1A23..20	68nF / 275 V / X1	20A
RGC1A23..25, RGC1A23..30	220 nF / 275V / X1	30A
RGC1A23..40	220 nF / 275V / X1 330 nF / 275V / X1	30A 45A
RGC1A23..60	220 nF / 275V / X1 330 nF / 275V / X1	30A 45A
RGC1A23..42, RGC1A23..62	330 nF / 275V / X1 680 nF / 275V / X1	35A 65A
RGC1A60..15	100 nF / 760V / X1	20A
RGC1A60..20	100 nF / 760V / X1	20A
RGC1A60..25, RGC1A60..30	220 nF / 760V / X1	30A
RGC1A60..40	220 nF / 760V / X1 330 nF / 760V / X1	25A 45A
RGC1A60..60	220 nF / 760V / X1 330 nF / 760V / X1	25A 45A
RGC1A60..32, RGC1A60..42, RGC1A60..62, RGC1A60..9x	330 nF / 760V / X1 680 nF / 760V / X1	40A 65A

Note:

- Control input lines must be installed together to maintain products' susceptibility to Radio Frequency interference.
- Use of AC solid state relays may, according to the application and the load current, cause conducted radio interferences. Use of mains filters may be necessary for cases where the user must meet E.M.C requirements. The capacitor values given inside the filtering specification tables should be taken only as indications, the filter attenuation will depend on the final application.
- Performance Criteria 1: No degradation of performance or loss of function is allowed when the product is operated as intended.
- Performance Criteria 2: During the test, degradation of performance or partial loss of function is allowed. However when the test is complete the product should return operating as intended by itself.
- Performance Criteria 3: Temporary loss of function is allowed, provided the function can be restored by manual operation of the controls.

Filter Connection Diagrams

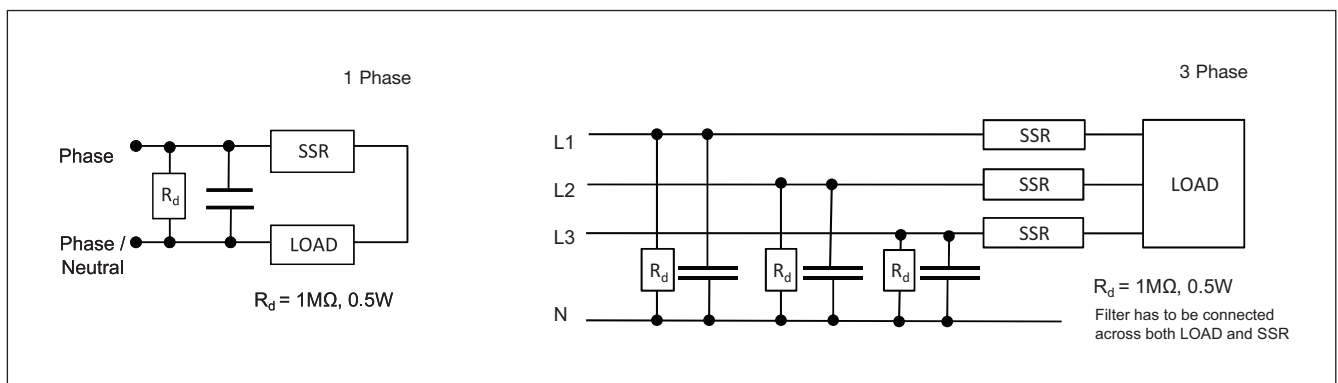

Functional Diagram (Without OTP)

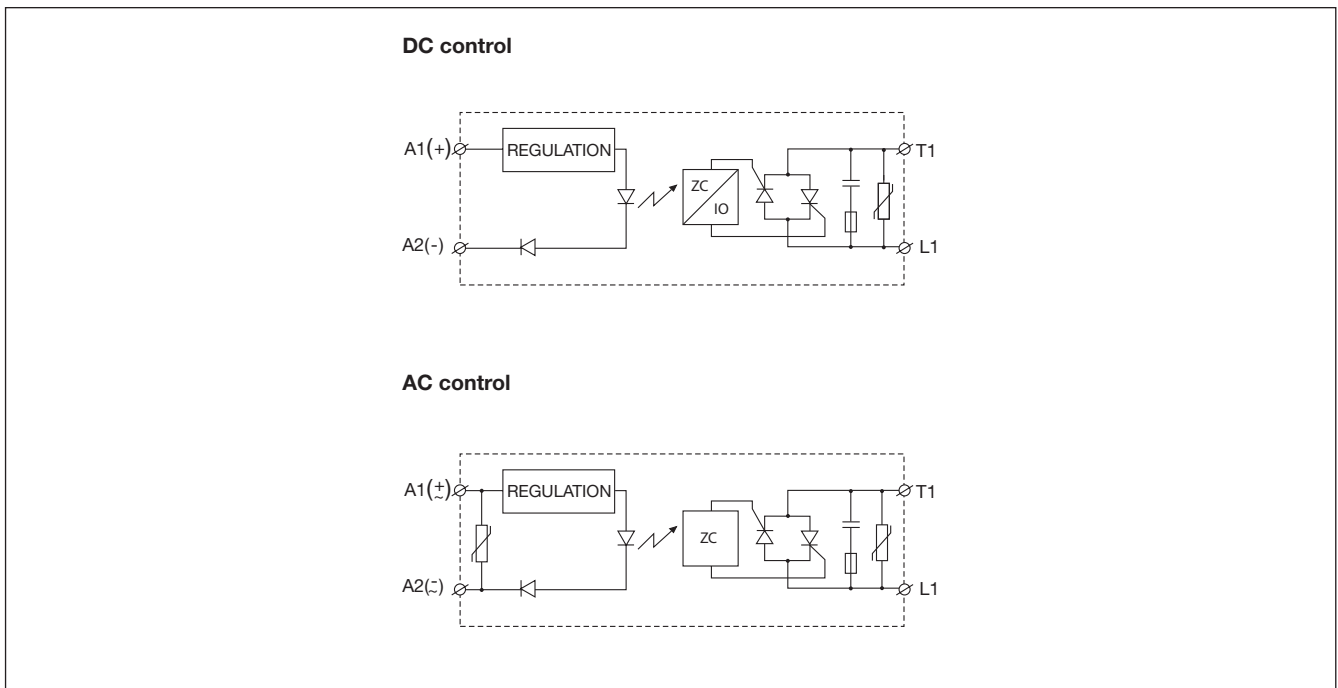

Connection Diagram (Without OTP)

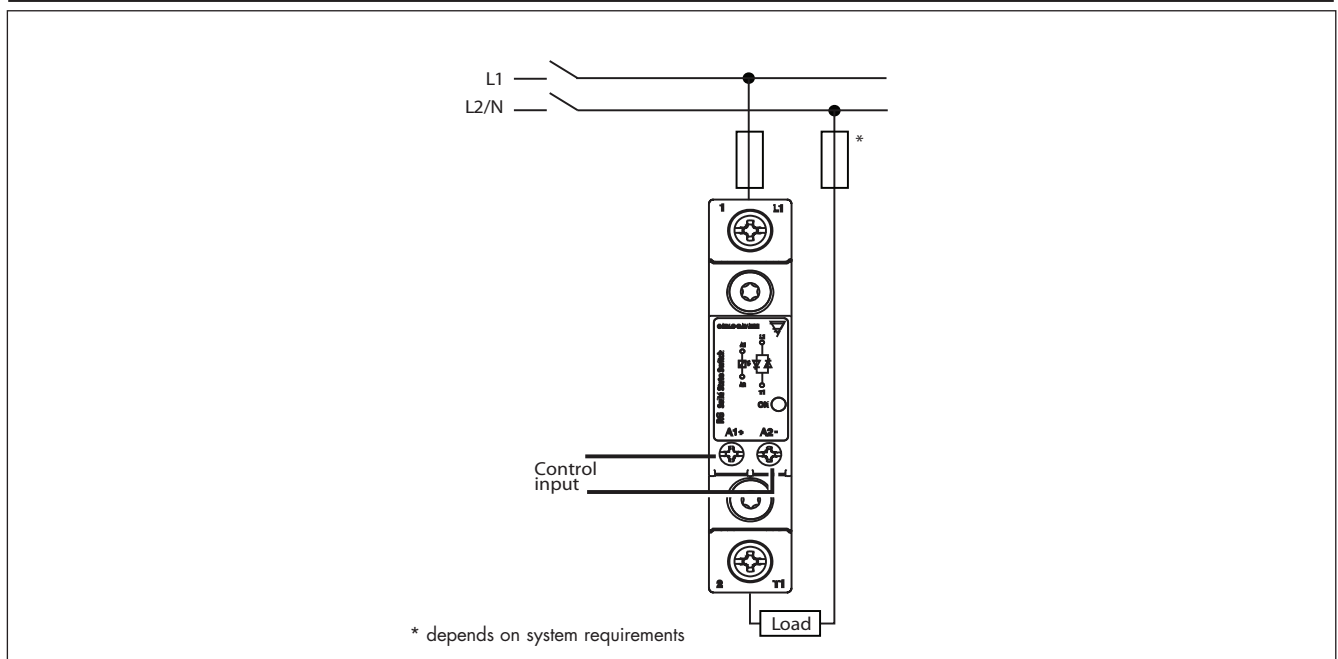

Connection Diagram (with OTP)

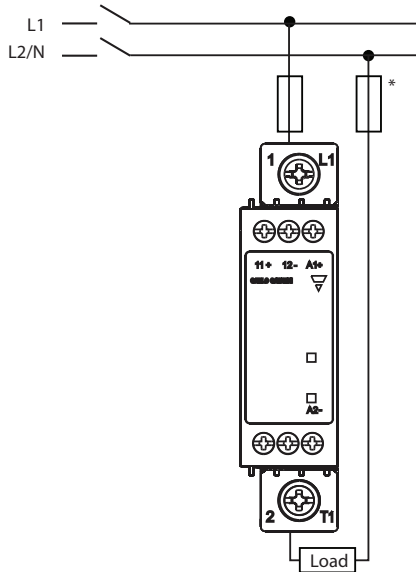

* depends on system requirements

DC Control

RGC1...D30GKEP, RGC1...D4xGGEP,
RGC1...D6xGGEP

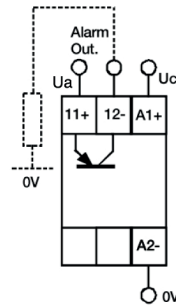

Uc: 5 - 32 VDC
Ua: max 35VDC
Alarm Output: max. 50mA

A1, A2: Control voltage
11, 12: Alarm output

RGC1...D9xGGEP

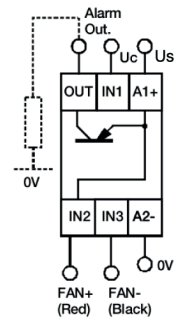

Uc: 5 - 32 VDC
Us: 24 VDC
Alarm Output: max. 50mA

Note: Fan is internally supplied

A1, A2: Supply voltage
IN1: Control voltage
OUT: Alarm output

AC Control

RGC1...A30GKEP, RGC1...A4xGGEP,
RGC1...A6xGGEP

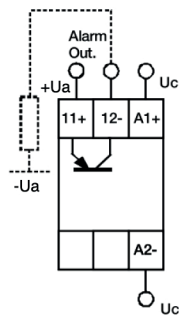

Uc: 24 - 275 VAC
24 - 190 VDC
Ua: max 35VDC
Alarm Output: max. 50mA

A1, A2: Control voltage
11, 12: Alarm output

RGC1...A9xGGEP

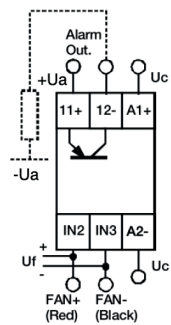

Uc: 24 - 275 VAC
24 - 190 VDC
Ua: max. 35 VDC
Alarm Output: max. 50mA
Ur: 24 VDC (needs to be supplied externally)

A1, A2: Control voltage
11, 12: Alarm output
IN2, IN3: Fan supply

Terminal Layout and Dimensions

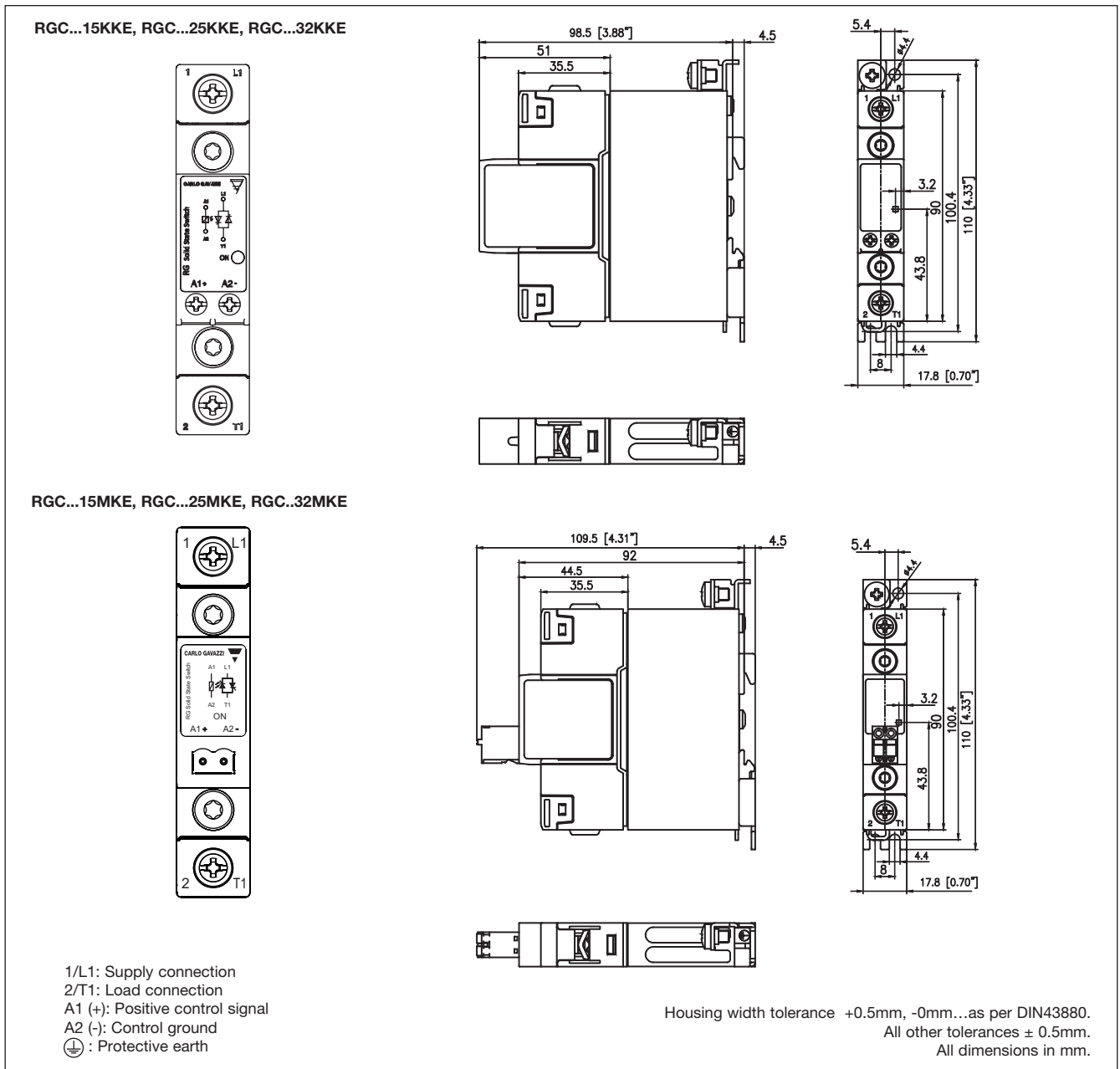

Terminal Layout and Dimensions (cont).

RGC..32KGE

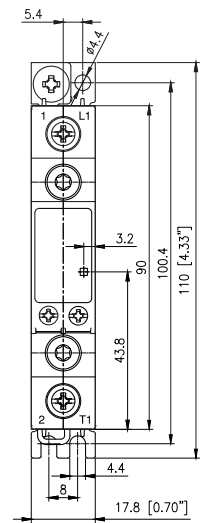
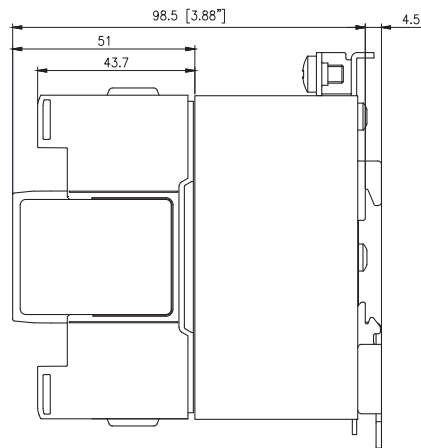
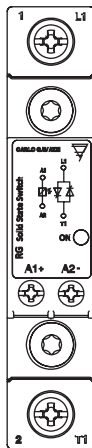

RGC..32MGE

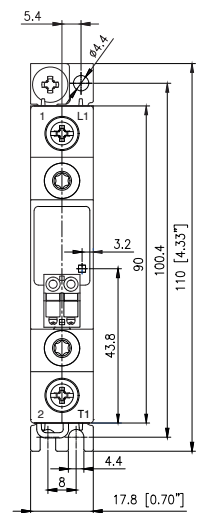
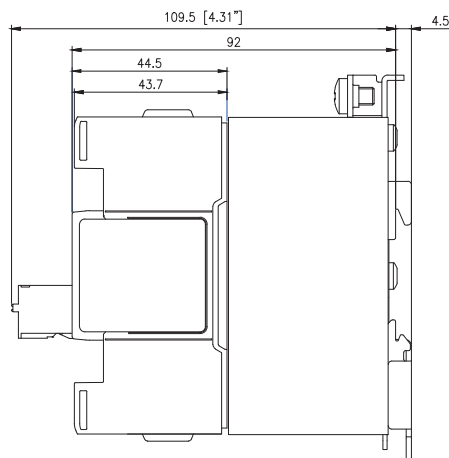
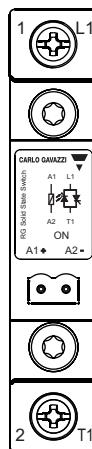

1/L1: Supply connection
 2/T1: Load connection
 A1 (+): Positive control signal
 A2 (-): Control ground
 ⊕: Protective earth

Housing width tolerance +0.5mm, -0mm...as per DIN43880.
 All other tolerances ± 0.5mm.
 All dimensions in mm.

Terminal Layout and Dimensions (cont).

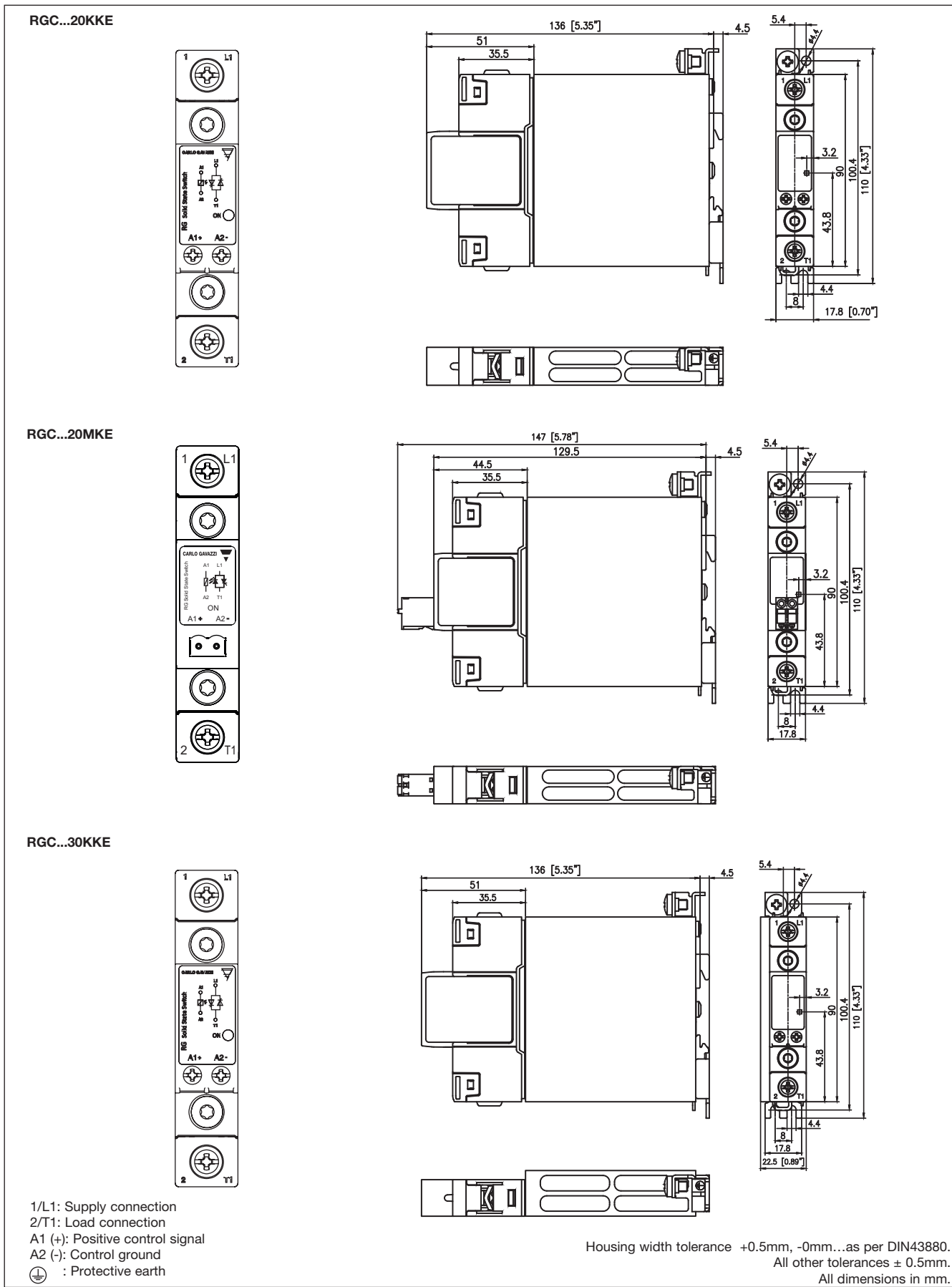

Terminal Layout and Dimensions (cont.)

RGC...30MKE

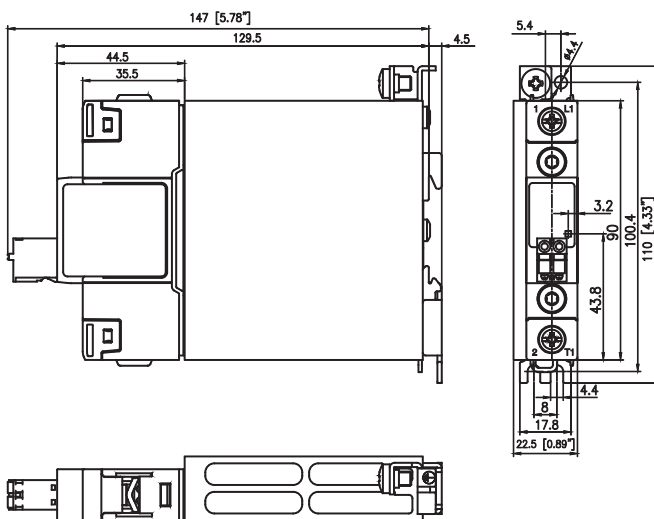
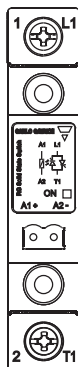

RGC...40KGE, RGC...42KGE

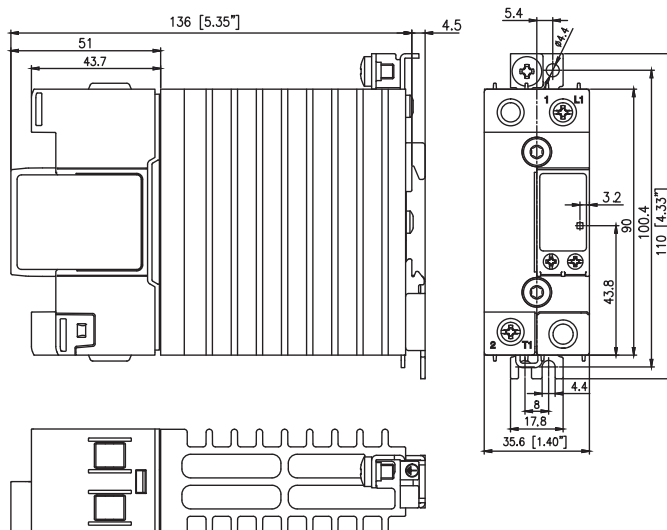
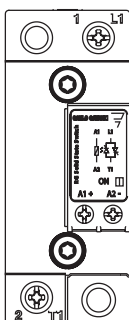

RGC...40MGE, RGC...42MGE

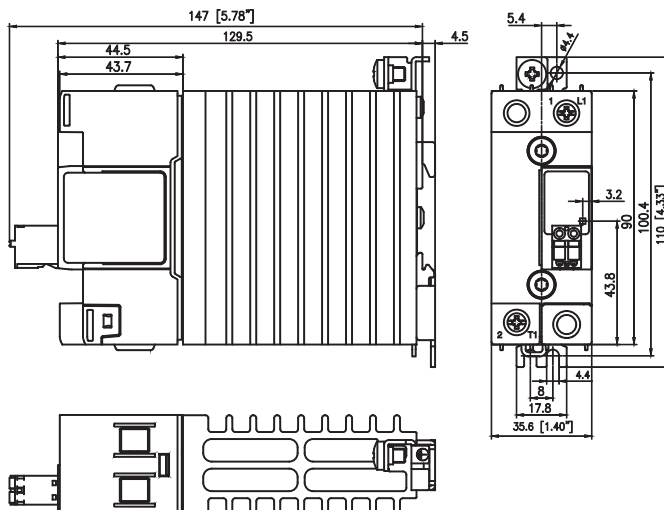
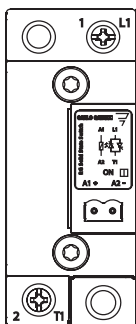

- 1/L1: Supply connection
- 2/T1: Load connection
- A1 (+): Positive control signal
- A2 (-): Control ground
- ⊕ : Protective earth

Housing width tolerance +0.5mm, -0mm...as per DIN43880.
All other tolerances ± 0.5mm. All dimensions in mm.

Terminal Layout and Dimensions (cont.)

RGC...60KGE, RGC...62KGE

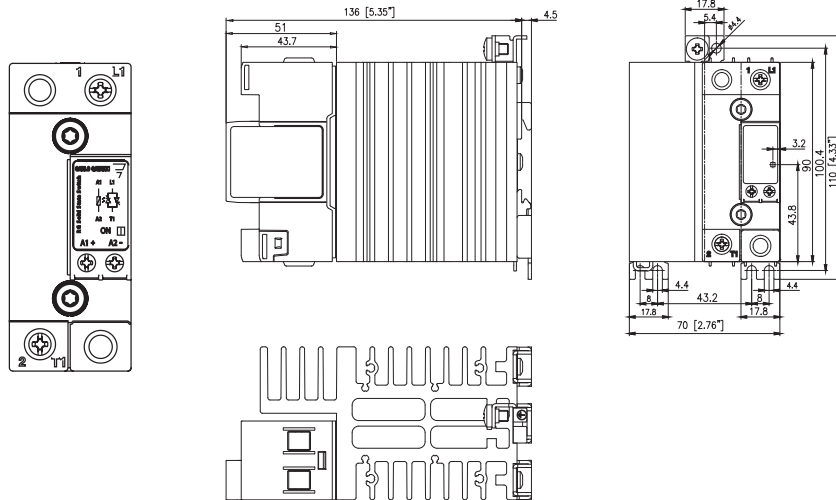

RGC...62MGE

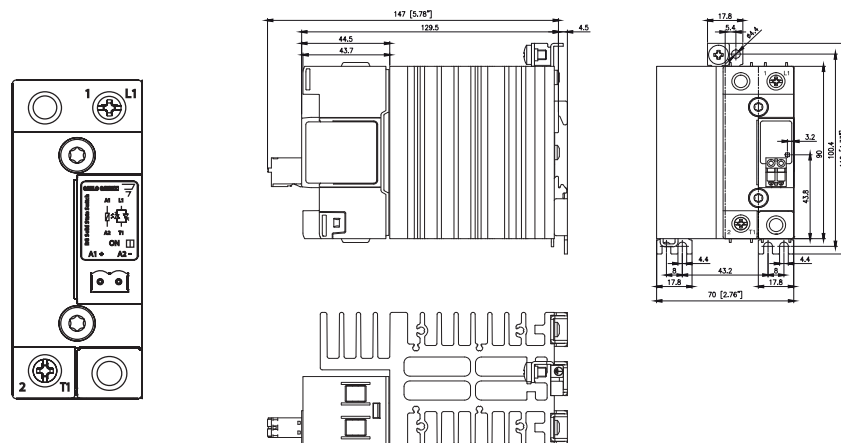

- 1/L1: Supply connection
- 2/T1: Load connection
- A1 (+): Positive control signal
- A2 (-): Control ground
- ⊕ : Protective earth

Housing width tolerance +0.5mm, -0mm...as per DIN43880.
 All other tolerances ± 0.5mm.
 All dimensions in mm.

Terminal Layout and Dimensions (cont.)

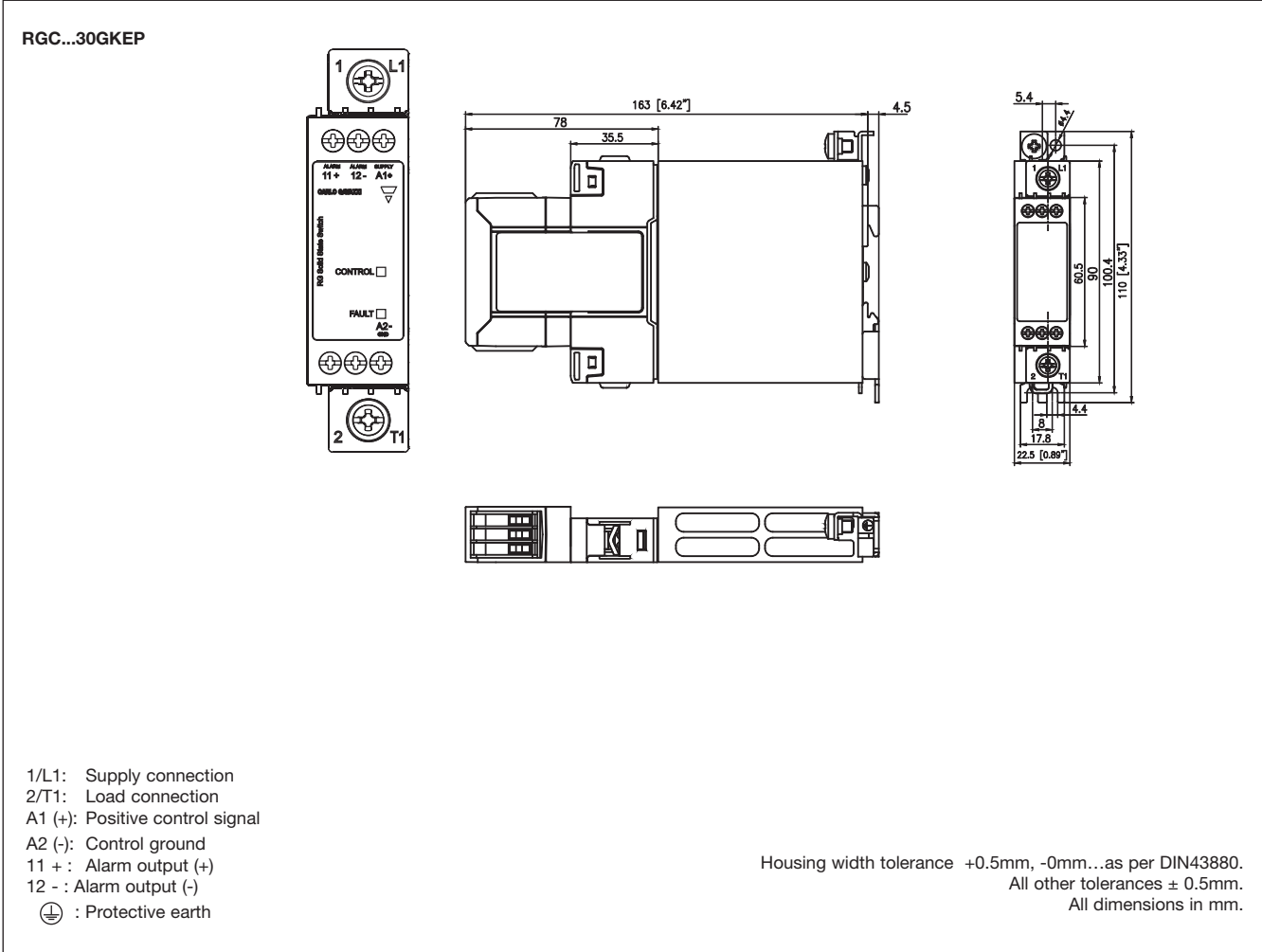

Terminal Layout and Dimensions (cont.)

RGC...40GGEP, RGC...42GGEP

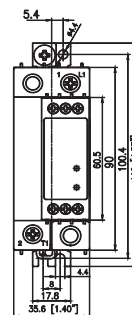
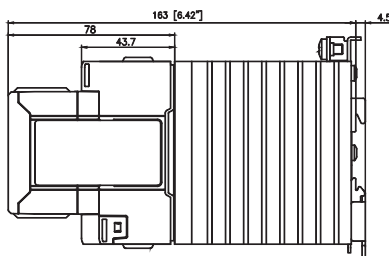
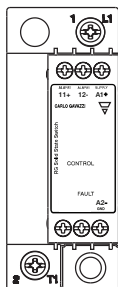

RGC...60GGEP, RGC...62GGEP

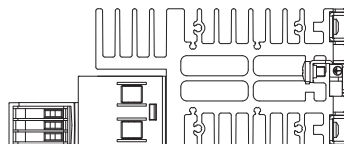
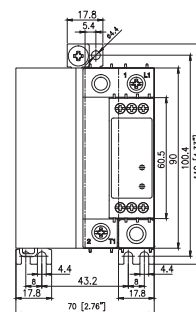
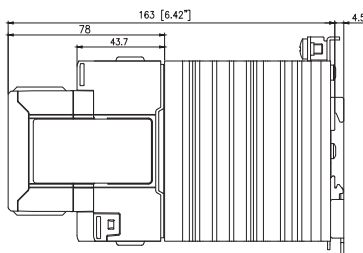
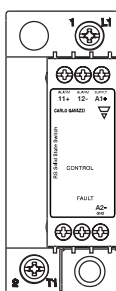

RGC...90GGEP, RGC...92GGEP

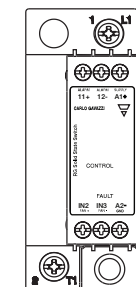
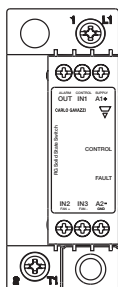

RGC...D9xGGEP

RGC...A9xGGEP

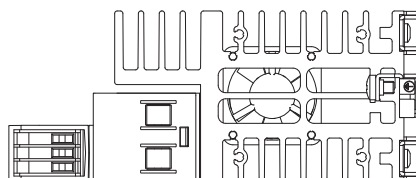
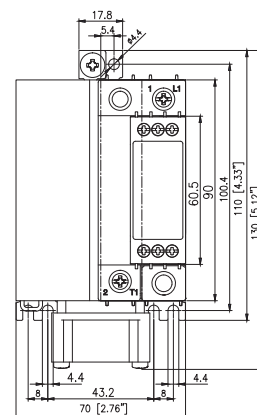
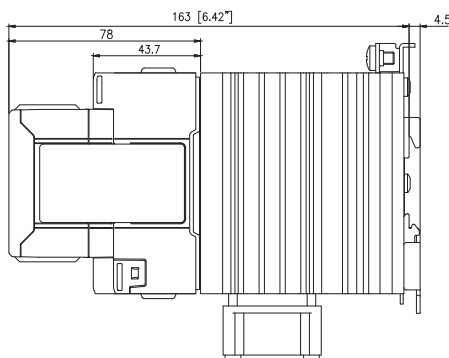







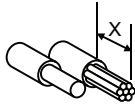

- 1/L1: Supply connection
- 2/T1: Load connection
- A1 (+): Positive control signal
(Positive supply in case of RGC1A60D9xGGEP)
- A2 (-): Control ground
- IN1: Control signal (only for RGC1A60D9xGGEP)
- IN2: Fan + supply (only for RGC1A60A9xGGEP)
- IN3: Fan - supply (only for RGC1A60A9xGGEP)
- 11 + : Alarm output (+)
- OUT, 12 - : Alarm output (-)
- : Protective earth

Housing width tolerance +0.5mm, -0mm...as per DIN43880.
All other tolerances ± 0.5mm. All dimensions in mm.

Connection Specifications

POWER CONNECTIONS: 1/L1, 2 /T1





Use 75°C copper (Cu) conductors

	RG...KKE ; RG..GKEP. ; RG...MKE		RG...KGE ; RG...GGEP ; RG...MGE	
Stripping Length (X)	12mm		11mm	
Connection type	M4 screw with captivated washer		M5 screw with box clamp	
Rigid (Solid & Stranded) UL / cUL rated data		 2 x 2.5..6 mm ² 2 x 14.. 10 AWG	 1 x 2.5..6 mm ² 1 x 14.. 10 AWG	 1 x 2.5..25mm ² 1 x 14...3 AWG
Flexible with end sleeve		2 x 1.0 ... 2.5mm ² 2 x 2.5..4mm ² 2 x 18.. 14 AWG 2 x 14.. 12 AWG	1 x 1.0..4mm ² 1 x 18.. 12 AWG	1 x 2.5..16mm ² 1 x 14.. 6 AWG
Flexible without end sleeve		2 x 1.0 ... 2.5mm ² 2 x 2.5.. 6mm ² 2 x 18.. 14 AWG 2 x 14.. 10 AWG	1 x 1.0.. 6mm ² 1 x 18.. 10 AWG	1 x 4.. 25mm ² 1 x 12.. 3 AWG
Torque specifications		Pozidriv 2 UL: 2Nm (17.7lb-in) IEC: 1.5 - 2.0Nm (13.3 - 17.7lb-in)	Posidriv 2 UL: 2.5Nm (22lb-in) IEC: 2.5 - 3.0Nm (22-26.6lb-in)	
Aperture for termination lug		12.3mm	N/A	
Protective Earth (PE) Connection		M5, 1.5Nm (13.3 lb-in)		

Note: M5 PE screw not provided with SSR. PE connection required when product is intended to be used in Class 1 applications according to EN/IEC 61140.

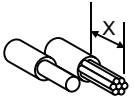

CONTROL CONNECTIONS: A1(+), A2(-)

Use 60/75°C copper (Cu) conductors

	RG...KKE, RG..KGE		RG...MKE, RG...MGE	
Torque specifications		M3, Pozidriv 1 UL: 0.5Nm (4.4lb-in) IEC: 0.5 - 0.6Nm (4.4 - 5.3lb-in)		
Stripping Length (X)		8mm	12 - 13mm	
Rigid (Solid & Stranded) UL/ cUL rated data		 2 x 0.5..2.5mm ² 2 x 18..12 AWG	 1 x 0.5..2.5mm ² 1 x 18..12 AWG	 1 x 0.2...2.5mm ² 1 x 24...12 AWG
Flexible with end sleeve		2 x 0.5..2.5mm ² 2 x 18..12AWG	1 x 0.5..2.5mm ² 1 x 18..12AWG	

CONTROL CONNECTIONS: A1(+), A2(-), IN1, IN2, IN3, 11 (+), 12(-), OUT

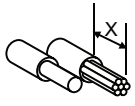
Use 60/75°C copper (Cu) conductors

	RG...GGEP	
Torque specifications		M3, Pozidriv 1 UL: 0.5Nm (4.4lb-in) IEC: 0.4 - 0.5Nm (3.5 - 4.4lb-in)
Stripping Length (X)		6mm 6mm
Rigid (Solid & Stranded) UL/ cUL rated data		 2 x 1.0..2.5mm ² 2 x 18..14 AWG
Flexible with end sleeve		2 x 1.0..2.5mm ² 2 x 18..14 AWG