



Chipsmall Limited consists of a professional team with an average of over 10 year of expertise in the distribution of electronic components. Based in Hongkong, we have already established firm and mutual-benefit business relationships with customers from,Europe,America and south Asia,supplying obsolete and hard-to-find components to meet their specific needs.

With the principle of “Quality Parts,Customers Priority,Honest Operation,and Considerate Service”,our business mainly focus on the distribution of electronic components. Line cards we deal with include Microchip,ALPS,ROHM,Xilinx,Pulse,ON,Everlight and Freescale. Main products comprise IC,Modules,Potentiometer,IC Socket,Relay,Connector.Our parts cover such applications as commercial,industrial, and automotives areas.

We are looking forward to setting up business relationship with you and hope to provide you with the best service and solution. Let us make a better world for our industry!



Contact us

Tel: +86-755-8981 8866 Fax: +86-755-8427 6832

Email & Skype: info@chipsmall.com Web: www.chipsmall.com

Address: A1208, Overseas Decoration Building, #122 Zhenhua RD., Futian, Shenzhen, China



APPROVAL SHEET

RGCMF Series – 1210(0504)- RoHS Compliance

MULTILAYER CERAMIC COMMON MODE FILTER

Halogens Free Product

P/N: RGCMF1210121H4T

*Contents in this sheet are subject to change without prior notice.

FEATURES

1. Miniature footprint: 1.25 X 1.00 X 0.8 mm³
2. Multilayer LTCC (Low Temperature Ceramic Cofired) Technology
3. Reflow solderable SMD Devices
4. Wide Pass Band (Cut-Off Frequency: -3dB@3GHz Typical)
5. High Attenuation for common mode noise
6. Special 3D layout design to minimize phase shifting

APPLICATIONS

1. EMI suppression on HDMI/ (mini)LVDS/ DVI/ SATA/ PCI-E/ Display Port high speed data transmission
2. PC related, LCD TV, PDP TV, Projector, STB, Blue-ray DVD, panel.

CONSTRUCTION

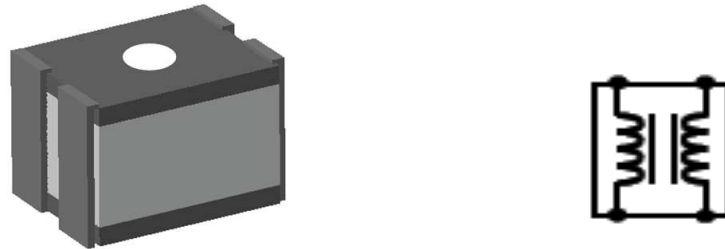
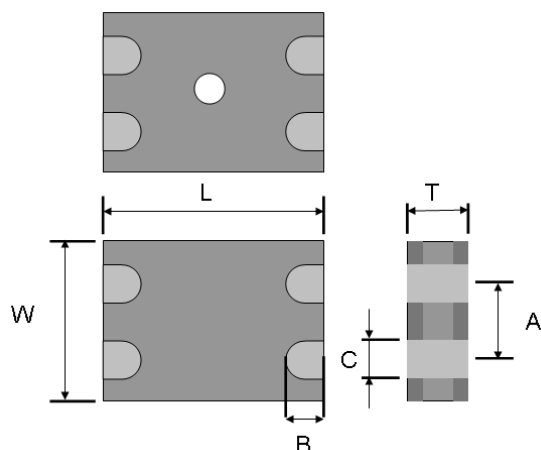

Fig 1. Outline of 1210 size Common Mode Filter and Schematics

DIMENSIONS

Figure	Symbol	Dimension
	L	1.25 ± 0.10mm
	W	1.00 ± 0.10mm
	T	0.80 ± 0.10mm
	A	0.55 ± 0.10mm
	B	0.20 ± 0.15mm
	C	0.30 ± 0.10mm

ELECTRICAL CHARACTERISTICS

RGCMF1210121H4T	Specification
Cut-off Frequency	3 GHz (Typical)
Common Mode Impedance	120 ohm ± 20% @ 100MHz
DC Resistance	Max. 1.2 Ω
Rated Current	300 mA
Characteristic Impedance (Differential)	100 Ω(Typical)
Operating Temperature	- 40 °C ~ +85 °C

Typical Electrical Chart

Insertion Loss vs Frequency Characteristic:

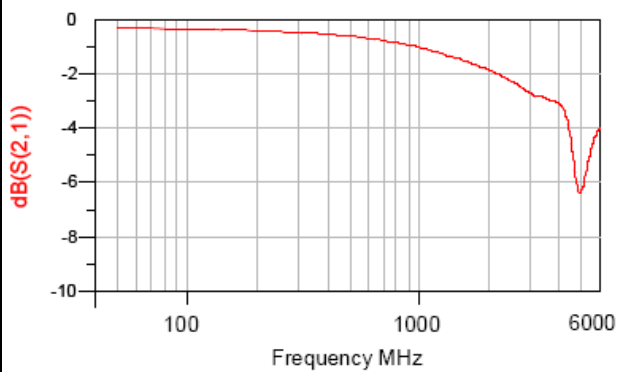

Impedance vs Frequency Characteristic:

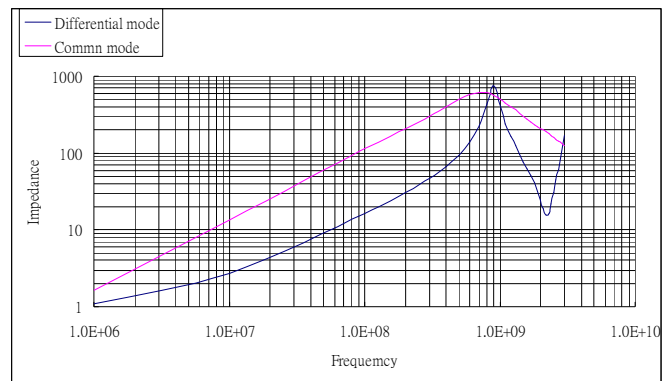

SOLDER LAND PATTERN

Figure	Symbol	Dimension (mm)
	L1	1.75 ± 0.05
	L2	0.30 ± 0.10
	L3	0.75 ± 0.05
	L4	0.55 ± 0.05

Line width to be designed to match 50 Ω characteristic impedance, depending on PCB material and thickness.

RELIABILITY TEST

Test item	Test condition / Test method	Specification
Solderability JIS C 0050-4.6 JESD22-B102D	*Solder bath temperature : $235 \pm 5^{\circ}\text{C}$ *Immersion time : 2 ± 0.5 sec *Solder : Sn3Ag0.5Cu for lead-free	At least 95% of a surface of each terminal electrode must be covered by fresh solder.
Leaching (Resistance to dissolution of metallization) IEC 60068-2-58	*Solder bath temperature : $260 \pm 5^{\circ}\text{C}$ *Leaching immersion time : 30 ± 0.5 sec *Solder : SN63A	Loss of metallization on the edges of each electrode shall not exceed 25%.
Resistance to soldering heat JIS C 0050-5.4	*Preheating temperature : $120\sim 150^{\circ}\text{C}$, 1 minute. *Solder temperature : $270\pm 5^{\circ}\text{C}$ *Immersion time : 10 ± 1 sec *Solder : Sn3Ag0.5Cu for lead-free Measurement to be made after keeping at room temperature for 24 ± 2 hrs	No mechanical damage. Samples shall satisfy electrical specification after test. Loss of metallization on the edges of each electrode shall not exceed 25%.
Drop Test JIS C 0044	*Height : 75 cm *Test Surface : Rigid surface of concrete or steel. *Times : 6 surfaces for each units ; 2 times for each side.	No mechanical damage. Samples shall satisfy electrical specification after test.
Adhesive Strength of Termination JIS C 0051- 7.4.3	*Pressurizing force : $5\text{N}(\leq 0603)$; $10\text{N}(>0603)$ *Test time : 10 ± 1 sec	No remarkable damage or removal of the termination.
Bending test JIS C 0051- 7.4.1	The middle part of substrate shall be pressurized by means of the pressurizing rod at a rate of about 1 mm/s per second until the deflection becomes 1mm/s and then pressure shall be maintained for 5 ± 1 sec. Measurement to be made after keeping at room temperature for 24 ± 2 hours	No mechanical damage. Samples shall satisfy electrical specification after test.

Approval sheet

<p>Temperature cycle JIS C 0025</p>	<p>1. 30±3 minutes at -40°C±3°C, 2. 10~15 minutes at room temperature, 3. 30±3 minutes at +85°C±3°C, 4. 10~15 minutes at room temperature, Total 100 continuous cycles Measurement to be made after keeping at room temperature for 24±2 hrs</p>	<p>No mechanical damage. Samples shall satisfy electrical specification after test.</p>
<p>Vibration JIS C 0040</p>	<p>*Frequency : 10Hz~55Hz~10Hz(1min) *Total amplitude : 1.5mm *Test times : 6hrs.(Two hrs each in three mutually perpendicular directions)</p>	<p>No mechanical damage. Samples shall satisfy electrical specification after test.</p>
<p>High temperature JIS C 0021</p>	<p>*Temperature : 85°C±2°C *Test duration : 1000+24/-0 hours Measurement to be made after keeping at room temperature for 24±2 hrs</p>	<p>No mechanical damage. Samples shall satisfy electrical specification after test.</p>
<p>Humidity (steady conditions) JIS C 0022</p>	<p>*Humidity : 90% to 95% R.H. *Temperature : 40±2°C *Time : 1000+24/-0 hrs. Measurement to be made after keeping at room temperature for 24±2 hrs ※ 500hrs measuring the first data then 1000hrs data</p>	<p>No mechanical damage. Samples shall satisfy electrical specification after test.</p>
<p>Low temperature JIS C 0020</p>	<p>*Temperature : -40°C±2°C *Test duration : 1000+24/-0 hours Measurement to be made after keeping at room temperature for 24±2 hrs</p>	<p>No mechanical damage. Samples shall satisfy electrical specification after test.</p>

SOLDERING CONDITION

Typical examples of soldering processes that provide reliable joints without any damage are given in Fig 2,

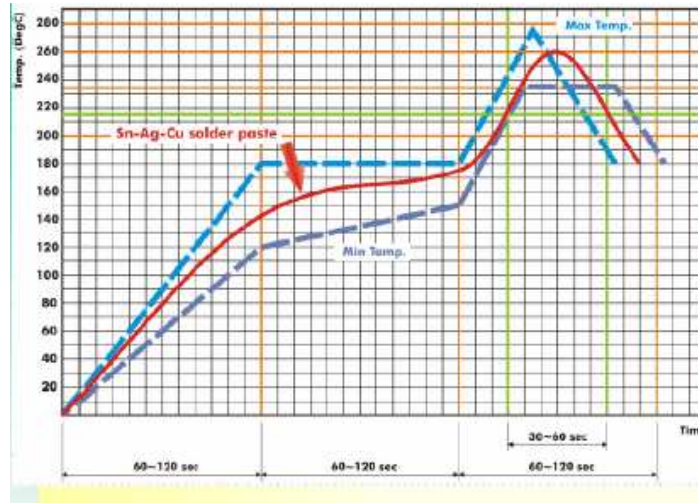

Fig 2. Infrared soldering profile

ORDERING CODE

RG Walsin RG device	CMF Product Code CMF : Common Mode Filter	1210 Dimension code 1210 = Width 12, Length 10,	121 CM Impedance 121:120 ohm	H Application H: HDMI/ DVI/ LVDS/ SATA/ PCI-/ D-Port	4 Specification Code from 0 ~ 9 dependent on different electrical specification	T Packing T: Reeled
----------------------------------	--	--	---	---	---	----------------------------------

Minimum Ordering Quantity: 2000 pcs per reel.

PACKAGING

Paper Tape specifications (unit :mm)

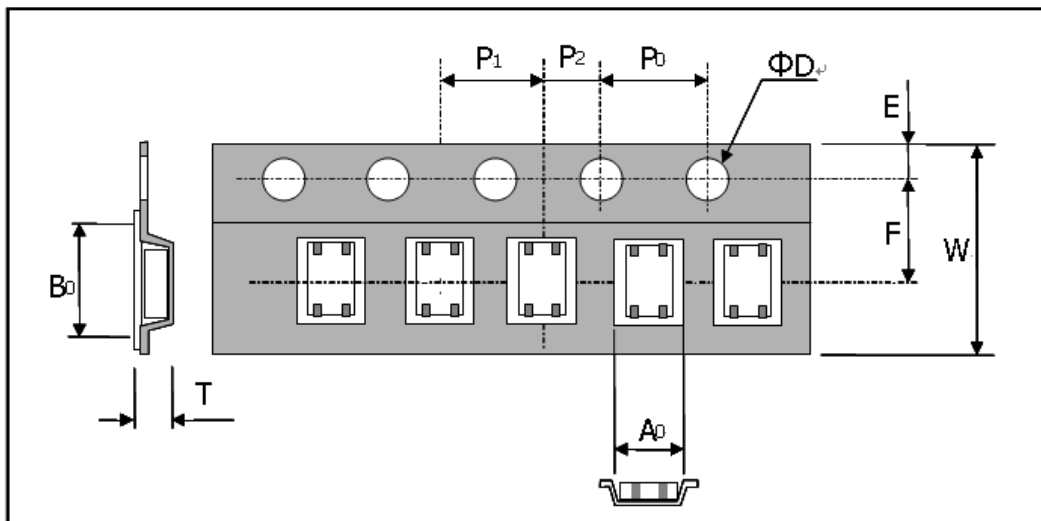

Index	A0	B0	ΦD	T	W
Dimension (mm)	1.20 ± 0.10	1.50 ± 0.10	1.50 ± 0.10	0.90 ± 0.10	8.00 ± 0.10
Index	E	F	P0	P1	P2
Dimension (mm)	1.75 ± 0.10	3.50 ± 0.05	4.00 ± 0.10	4.00 ± 0.10	2.00 ± 0.05

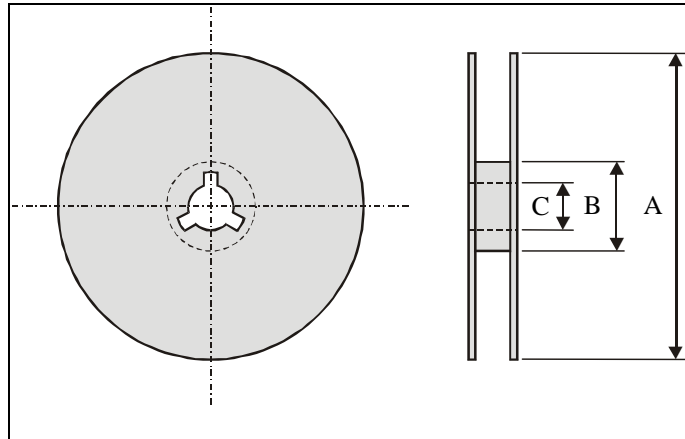
Reel dimensions

Index	A	B	C
Dimension (mm)	Φ178.0	Φ60.0	Φ13.0

Taping Quantity:2000 pieces per 7" reel

CAUTION OF HANDLING**Limitation of Applications**

Please contact us before using our products for the applications listed below which require especially high reliability for the prevention of defects, which might directly cause damage to the third party's life, body or property.

- (1) Aircraft equipment
- (2) Aerospace equipment
- (3) Undersea equipment
- (4) Medical equipment
- (5) Disaster prevention / crime prevention equipment
- (6) Traffic signal equipment
- (7) Transportation equipment (vehicles, trains, ships, etc.)
- (8) Applications of similar complexity and /or reliability requirements to the applications listed in the above.

Storage condition

- (1) Products in N₂ gas sealed bag should be used in 6 months from the day of WALSIN outgoing inspection and 1 month after open, which can be confirmed the quality.



- (2) Storage environment condition.

- Products should be storage in the warehouse on the following conditions.
- Temperature : -10 to +40°C
- Humidity : 30 to 70% relative humidity
- Don't keep products in corrosive gases such as sulfur. Chlorine gas or acid or it may cause oxidization of electrode, resulting in poor solderability.
- Products should be storage on the palette for the prevention of the influence from humidity, dust and son on.
- Products should be storage in the warehouse without heat shock, vibration, direct sunlight and so on.
- Products should be storage under the airtight packaged condition.