



Chipsmall Limited consists of a professional team with an average of over 10 year of expertise in the distribution of electronic components. Based in Hongkong, we have already established firm and mutual-benefit business relationships with customers from,Europe,America and south Asia,supplying obsolete and hard-to-find components to meet their specific needs.

With the principle of "Quality Parts,Customers Priority,Honest Operation,and Considerate Service",our business mainly focus on the distribution of electronic components. Line cards we deal with include Microchip,ALPS,ROHM,Xilinx,Pulse,ON,Everlight and Freescale. Main products comprise IC,Modules,Potentiometer,IC Socket,Relay,Connector.Our parts cover such applications as commercial,industrial, and automotives areas.

We are looking forward to setting up business relationship with you and hope to provide you with the best service and solution. Let us make a better world for our industry!



## Contact us

Tel: +86-755-8981 8866 Fax: +86-755-8427 6832

Email & Skype: info@chipsmall.com Web: www.chipsmall.com

Address: A1208, Overseas Decoration Building, #122 Zhenhua RD., Futian, Shenzhen, China





Is Now Part of



**ON Semiconductor®**

To learn more about ON Semiconductor, please visit our website at  
[www.onsemi.com](http://www.onsemi.com)

ON Semiconductor and the ON Semiconductor logo are trademarks of Semiconductor Components Industries, LLC dba ON Semiconductor or its subsidiaries in the United States and/or other countries. ON Semiconductor owns the rights to a number of patents, trademarks, copyrights, trade secrets, and other intellectual property. A listing of ON Semiconductor's product/patent coverage may be accessed at [www.onsemi.com/site/pdf/Patent-Marking.pdf](http://www.onsemi.com/site/pdf/Patent-Marking.pdf). ON Semiconductor reserves the right to make changes without further notice to any products herein. ON Semiconductor makes no warranty, representation or guarantee regarding the suitability of its products for any particular purpose, nor does ON Semiconductor assume any liability arising out of the application or use of any product or circuit, and specifically disclaims any and all liability, including without limitation special, consequential or incidental damages. Buyer is responsible for its products and applications using ON Semiconductor products, including compliance with all laws, regulations and safety requirements or standards, regardless of any support or applications information provided by ON Semiconductor. "Typical" parameters which may be provided in ON Semiconductor data sheets and/or specifications can and do vary in different applications and actual performance may vary over time. All operating parameters, including "Typicals" must be validated for each customer application by customer's technical experts. ON Semiconductor does not convey any license under its patent rights nor the rights of others. ON Semiconductor products are not designed, intended, or authorized for use as a critical component in life support systems or any FDA Class 3 medical devices or medical devices with a same or similar classification in a foreign jurisdiction or any devices intended for implantation in the human body. Should Buyer purchase or use ON Semiconductor products for any such unintended or unauthorized application, Buyer shall indemnify and hold ON Semiconductor and its officers, employees, subsidiaries, affiliates, and distributors harmless against all claims, costs, damages, and expenses, and reasonable attorney fees arising out of, directly or indirectly, any claim of personal injury or death associated with such unintended or unauthorized use, even if such claim alleges that ON Semiconductor was negligent regarding the design or manufacture of the part. ON Semiconductor is an Equal Opportunity/Affirmative Action Employer. This literature is subject to all applicable copyright laws and is not for resale in any manner.



August 2014

# RHRG1560CC\_F085 15A, 600V Hyperfast Rectifier

RHRG1560CC\_F085 15A, 600V Hyperfast Rectifier

## Features

- High Speed Switching (  $t_{rr}$ =26ns(Typ.) @  $I_F$ =15A )
- Low Forward Voltage(  $V_F$ =1.86V(Typ.) @  $I_F$ =15A )
- Avalanche Energy Rated
- AEC-Q101 Qualified

## Applications

- Switching Power Supply
- Power Switching Circuits
- Automotive and General Purpose

## Max Ratings (600V, 15A)

The RHRG1560CC\_F085 is an Hyperfast™ diode with soft recovery characteristics ( $t_{rr} < 55ns$ ). It has half the recovery time of ultrafast diode and is of silicon nitride passivated ion-implanted epitaxial planar construction. This device is intended for use as a freewheeling/clamping diode and rectifier in a variety of automotive switching power supplies and other power switching automotive applications. Its low stored charge and hyperfast soft recovery minimize ringing and electrical noise in many power switching circuits, thus reducing power loss in the switching transistors.

## Pin Assignments

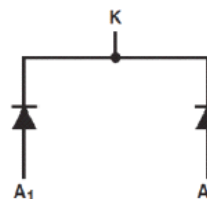
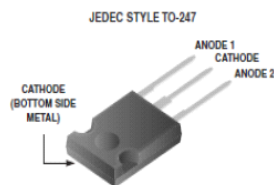

## Absolute Maximum Ratings $T_C = 25^\circ C$ unless otherwise noted

Symbol	Parameter	Ratings	Units
$V_{RRM}$	Peak Repetitive Reverse Voltage	600	V
$V_{RWM}$	Working Peak Reverse Voltage	600	V
$V_R$	DC Blocking Voltage	600	V
$I_{F(AV)}$	Average Rectified Forward Current @ $T_C = 25^\circ C$	15	A
$I_{FSM}$	Non-repetitive Peak Surge Current (Halfwave 1 Phase 50Hz)	45	A
$E_{AVL}$	Avalanche Energy (1A, 40mH)	20	mJ
$T_J, T_{STG}$	Operating Junction and Storage Temperature	- 55 to +175	$^\circ C$

## Thermal Characteristics $T_C = 25^\circ C$ unless otherwise noted

Symbol	Parameter	Max	Units
$R_{\theta JC}$	Maximum Thermal Resistance, Junction to Case	1.37	$^\circ C/W$
$R_{\theta JA}$	Maximum Thermal Resistance, Junction to Ambient	45	$^\circ C/W$

## Package Marking and Ordering Information

Device Marking	Device	Package	Tube	Quantity
RHRG1560CC	RHRG1560CC_F085	TO-247	-	30

## Electrical Characteristics T<sub>C</sub> = 25°C unless otherwise noted

Symbol	Parameter	Conditions	Min.	Typ.	Max	Units	
I <sub>R</sub>	Instantaneous Reverse Current	V <sub>R</sub> = 600V	T <sub>C</sub> = 25 °C	-	-	100	uA
			T <sub>C</sub> = 175 °C	-	-	1000	uA
V <sub>FM</sub> <sup>1</sup>	Instantaneous Forward Voltage	I <sub>F</sub> = 15A	T <sub>C</sub> = 25 °C	-	1.86	2.3	V
			T <sub>C</sub> = 175 °C	-	1.28	1.6	V
t <sub>rr</sub> <sup>2</sup>	Reverse Recovery Time	I <sub>F</sub> = 1A, di/dt = 100A/μs, V <sub>CC</sub> = 390V	T <sub>C</sub> = 25 °C	-	25	50	ns
			I <sub>F</sub> = 15A, di/dt = 100A/μs, V <sub>CC</sub> = 390V	T <sub>C</sub> = 25 °C	-	26	55
			T <sub>C</sub> = 175 °C	-	137	-	ns
t <sub>a</sub>	Reverse Recovery Time	I <sub>F</sub> = 15A, di/dt = 100A/μs, V <sub>CC</sub> = 390V	T <sub>C</sub> = 25 °C	-	15	-	ns
t <sub>b</sub>	Reverse Recovery Time			-	11	-	ns
Q <sub>rr</sub>	Reverse Recovery Charge			-	21	-	nC

### Notes:

1. Pulse : Test Pulse width = 300μs, Duty Cycle = 2%
2. Guaranteed by design

## Test Circuit and Waveforms

### t<sub>rr</sub> Test Circuit

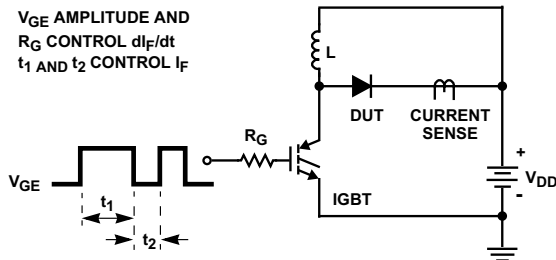

### t<sub>rr</sub> Waveforms and Definitions

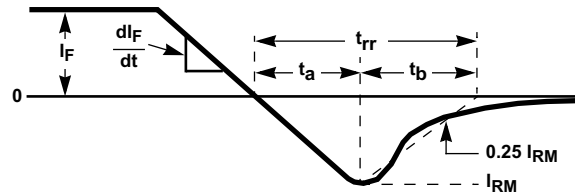

### Avalanche Energy Test Circuit

I = 1A  
 L = 40mH  
 R < 0.1Ω  
 $E_{AVL} = 1/2LI^2 [V_{R(AVL)}/(V_{R(AVL)} - V_{DD})]$   
 Q<sub>1</sub> = IGBT (BV<sub>CES</sub> > DUT V<sub>R(AVL)</sub>)

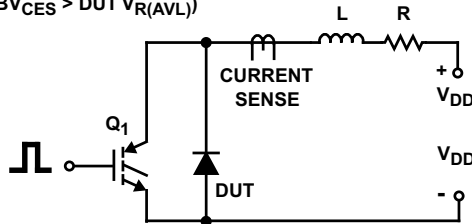

### Avalanche Current and Voltage Waveforms

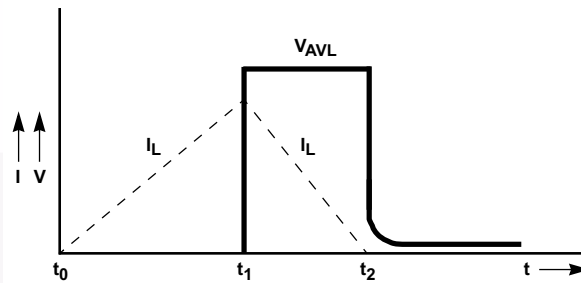

## Typical Performance Characteristics

**Figure 1. Typical Forward Voltage Drop vs. Forward Current**

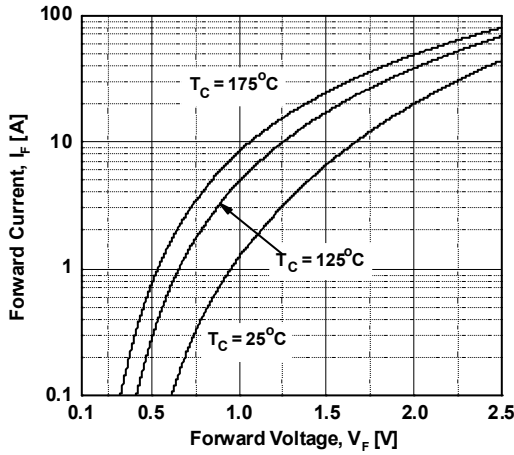

**Figure 3. Typical Junction Capacitance**

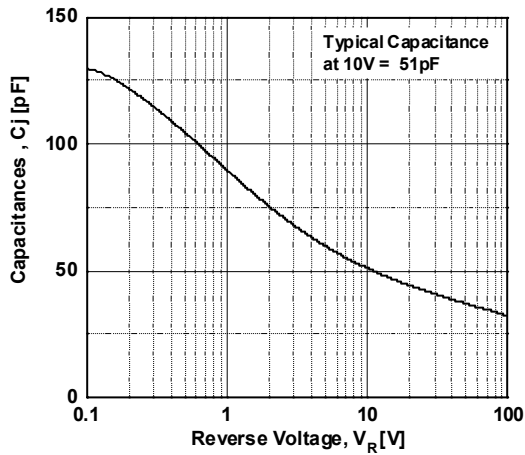

**Figure 5. Typical Reverse Recovery Current vs. di/dt**

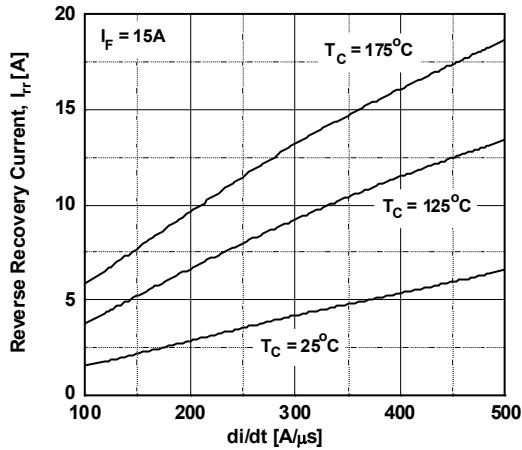

**Figure 2. Typical Reverse Current vs. Reverse Voltage**

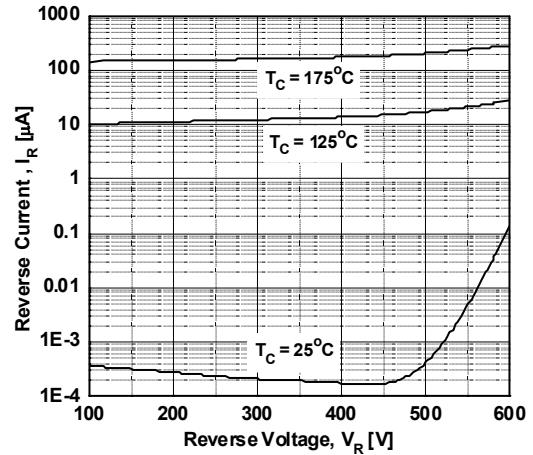

**Figure 4. Typical Reverse Recovery Time vs. di/dt**

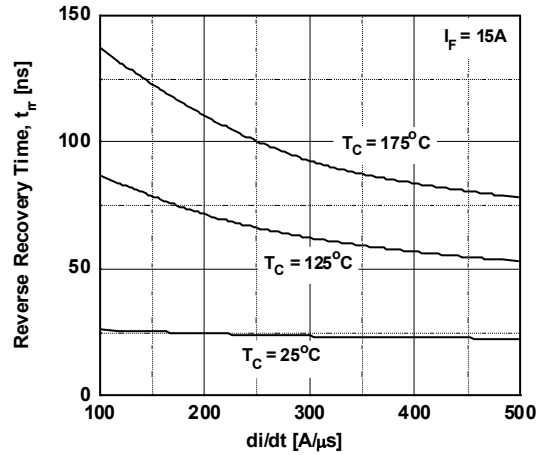

**Figure 6. Forward Current Derating Curve**

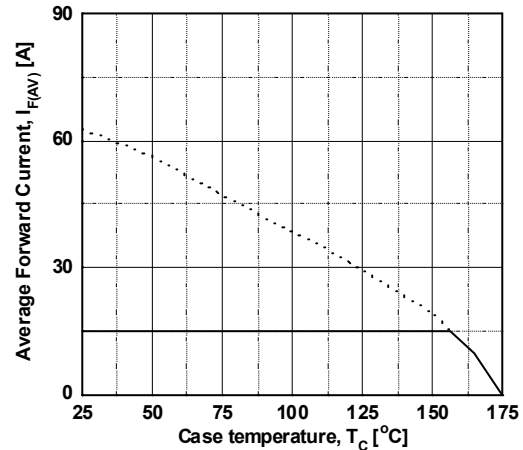

Typical Performance Characteristics (Continued)

Figure 7. Reverse Recovery Charge

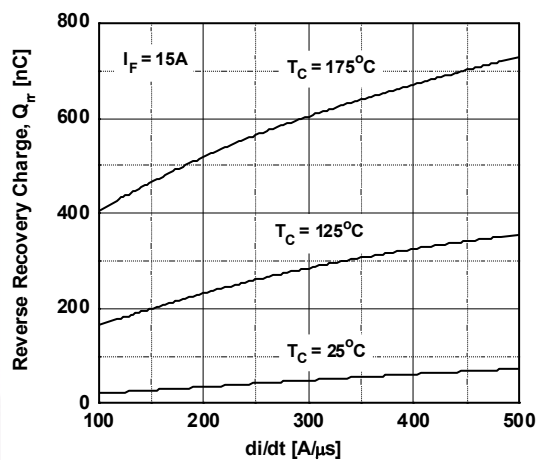
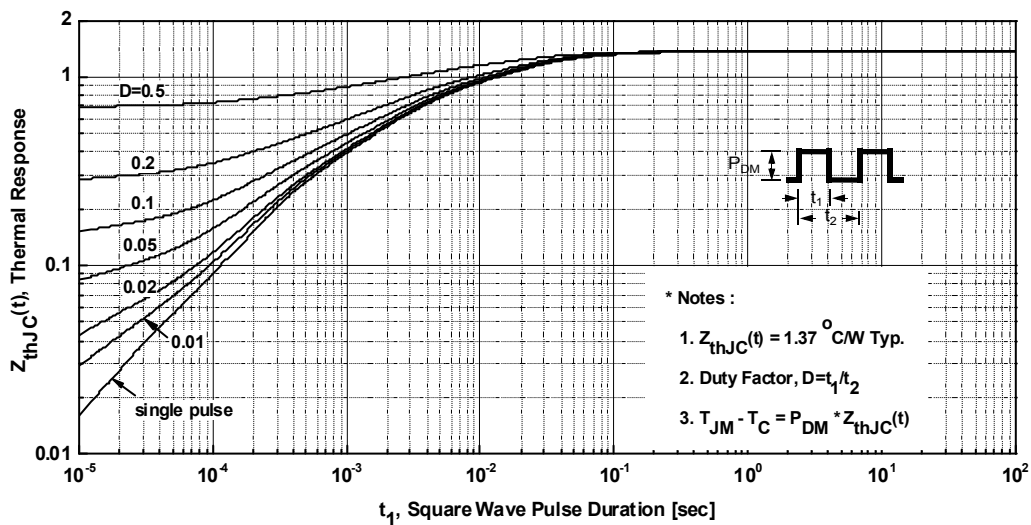
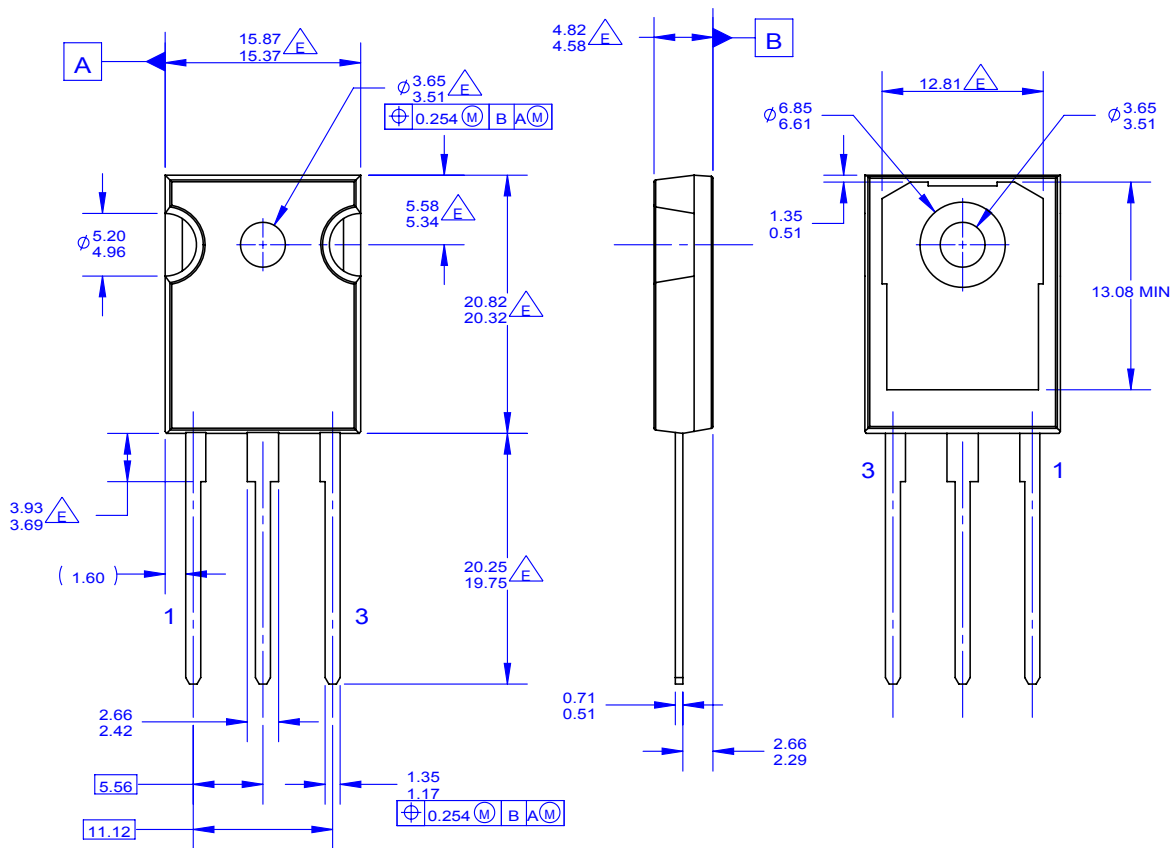

Figure 8. Transient Thermal Response Curve



Mechanical Dimensions

TO-247-3L



NOTES: UNLESS OTHERWISE SPECIFIED.

- A. PACKAGE REFERENCE: JEDEC TO-247, ISSUE E, VARIATION AB, DATED JUNE, 2004.
- B. DIMENSIONS ARE EXCLUSIVE OF BURRS, MOLD FLASH, AND TIE BAR EXTRUSIONS.
- C. ALL DIMENSIONS ARE IN MILLIMETERS.
- D. DRAWING CONFORMS TO ASME Y14.5 - 1994





$\triangle E$  DOES NOT COMPLY JEDEC STANDARD VALUE  
 F. DRAWING FILENAME: MKT-TO247G03\_REV01

Dimensions in Millimeters



**TRADEMARKS**

The following includes registered and unregistered trademarks and service marks, owned by Fairchild Semiconductor and/or its global subsidiaries, and is not intended to be an exhaustive list of all such trademarks.

- |   |   |   |   |
|---|---|---|---|
| AccuPower™  | F-PFS™  |  ™ |  SYSTEM® |
| Awinda®   | FRFET®  | PowerTrench®  | TinyBoost®  |
| AX-CAP®*  | Global Power ResourceSM                         | PowerXS™  | TinyBuck®   |
| BitSiC™   | GreenBridge™                                    | Programmable Active Droop™  | TinyCalc™   |
| Build it Now™   | Green FPS™                                      | QFET®   | TinyLogic®  |
| CorePLUS™   | Green FPS™ e-Series™                            | QS™   | TINYOPTO™   |
| CorePOWER™  | Gmax™   | Quiet Series™   | TinyPower™  |
| CROSSVOLT™  | GTO™  | RapidConfigure™   | TinyPWM™  |
| CTL™  | IntelliMAX™                                     |  ™ | TinyWire™   |
| Current Transfer Logic™   | ISOPLANAR™                                      | Saving our world, 1mW/W/kW at a time™   | TranSiC™  |
| DEUXPEED®   | Marking Small Speakers Sound Louder and Better™ | SignalWise™   | TriFault Detect™  |
| Dual Cool™  | MegaBuck™                                       | SmartMax™   | TRUECURRENT®*   |
| EcoSPARK®   | MICROCOUPLER™                                   | SMART START™  | μSerDes™  |
| EfficientMax™   | MicroFET™                                       | Solutions for Your Success™   |  SerDes™ |
| ESBC™   | MicroPak™                                       | SPM®  | UHC®  |
|  ™ | MicroPak2™                                      | STEALTH™  | Ultra FRFET™  |
| Fairchild®  | MillerDrive™                                    | SuperFET®   | UniFET™   |
| Fairchild Semiconductor®  | MotionMax™                                      | SuperSOT™-3   | VCX™  |
| FACT Quiet Series™  | MotionGrid®                                     | SuperSOT™-6   | VisualMax™  |
| FACT®   | MTi®  | SuperSOT™-8   | VoltagePlus™  |
| FAST®   | MTx®  | SupreMOS®   | XS™   |
| FastvCore™  | MVN®  | SyncFET™  | Xsens™  |
| FETBench™   | mWSave®   | Sync-Lock™  | 仙童™   |
| FPS™  | OptoHiT™  |   |   |

\*Trademarks of System General Corporation, used under license by Fairchild Semiconductor.

**DISCLAIMER**

FAIRCHILD SEMICONDUCTOR RESERVES THE RIGHT TO MAKE CHANGES WITHOUT FURTHER NOTICE TO ANY PRODUCTS HEREIN TO IMPROVE RELIABILITY, FUNCTION, OR DESIGN. TO OBTAIN THE LATEST, MOST UP-TO-DATE DATASHEET AND PRODUCT INFORMATION, VISIT OUR WEBSITE AT [HTTP://WWW.FAIRCHILDSEMI.COM](http://www.fairchildsemi.com). FAIRCHILD DOES NOT ASSUME ANY LIABILITY ARISING OUT OF THE APPLICATION OR USE OF ANY PRODUCT OR CIRCUIT DESCRIBED HEREIN; NEITHER DOES IT CONVEY ANY LICENSE UNDER ITS PATENT RIGHTS, NOR THE RIGHTS OF OTHERS. THESE SPECIFICATIONS DO NOT EXPAND THE TERMS OF FAIRCHILD'S WORLDWIDE TERMS AND CONDITIONS, SPECIFICALLY THE WARRANTY THEREIN, WHICH COVERS THESE PRODUCTS.

**LIFE SUPPORT POLICY**

FAIRCHILD'S PRODUCTS ARE NOT AUTHORIZED FOR USE AS CRITICAL COMPONENTS IN LIFE SUPPORT DEVICES OR SYSTEMS WITHOUT THE EXPRESS WRITTEN APPROVAL OF FAIRCHILD SEMICONDUCTOR CORPORATION.

As used here in:

1. Life support devices or systems are devices or systems which, (a) are intended for surgical implant into the body or (b) support or sustain life, and (c) whose failure to perform when properly used in accordance with instructions for use provided in the labeling, can be reasonably expected to result in a significant injury of the user.
2. A critical component in any component of a life support, device, or system whose failure to perform can be reasonably expected to cause the failure of the life support device or system, or to affect its safety or effectiveness.

**ANTI-COUNTERFEITING POLICY**

Fairchild Semiconductor Corporation's Anti-Counterfeiting Policy. Fairchild's Anti-Counterfeiting Policy is also stated on our external website, [www.fairchildsemi.com](http://www.fairchildsemi.com), under Sales Support.

Counterfeiting of semiconductor parts is a growing problem in the industry. All manufactures of semiconductor products are experiencing counterfeiting of their parts. Customers who inadvertently purchase counterfeit parts experience many problems such as loss of brand reputation, substandard performance, failed application, and increased cost of production and manufacturing delays. Fairchild is taking strong measures to protect ourselves and our customers from the proliferation of counterfeit parts. Fairchild strongly encourages customers to purchase Fairchild parts either directly from Fairchild or from Authorized Fairchild Distributors who are listed by country on our web page cited above. Products customers buy either from Fairchild directly or from Authorized Fairchild Distributors are genuine parts, have full traceability, meet Fairchild's quality standards for handling and storage and provide access to Fairchild's full range of up-to-date technical and product information. Fairchild and our Authorized Distributors will stand behind all warranties and will appropriately address and warranty issues that may arise. Fairchild will not provide any warranty coverage or other assistance for parts bought from Unauthorized Sources. Fairchild is committed to combat this global problem and encourage our customers to do their part in stopping this practice by buying direct or from authorized distributors.

**PRODUCT STATUS DEFINITIONS**

**Definition of Terms**

Datasheet Identification	Product Status	Definition
Advance Information	Formative / In Design	Datasheet contains the design specifications for product development. Specifications may change in any manner without notice.
Preliminary	First Production	Datasheet contains preliminary data; supplementary data will be published at a later date. Fairchild Semiconductor reserves the right to make changes at any time without notice to improve design.
No Identification Needed	Full Production	Datasheet contains final specifications. Fairchild Semiconductor reserves the right to make changes at any time without notice to improve the design.
Obsolete	Not In Production	Datasheet contains specifications on a product that is discontinued by Fairchild Semiconductor. The datasheet is for reference information only.



ON Semiconductor and  are trademarks of Semiconductor Components Industries, LLC dba ON Semiconductor or its subsidiaries in the United States and/or other countries. ON Semiconductor owns the rights to a number of patents, trademarks, copyrights, trade secrets, and other intellectual property. A listing of ON Semiconductor's product/patent coverage may be accessed at [www.onsemi.com/site/pdf/Patent-Marking.pdf](http://www.onsemi.com/site/pdf/Patent-Marking.pdf). ON Semiconductor reserves the right to make changes without further notice to any products herein. ON Semiconductor makes no warranty, representation or guarantee regarding the suitability of its products for any particular purpose, nor does ON Semiconductor assume any liability arising out of the application or use of any product or circuit, and specifically disclaims any and all liability, including without limitation special, consequential or incidental damages. Buyer is responsible for its products and applications using ON Semiconductor products, including compliance with all laws, regulations and safety requirements or standards, regardless of any support or applications information provided by ON Semiconductor. "Typical" parameters which may be provided in ON Semiconductor data sheets and/or specifications can and do vary in different applications and actual performance may vary over time. All operating parameters, including "Typicals" must be validated for each customer application by customer's technical experts. ON Semiconductor does not convey any license under its patent rights nor the rights of others. ON Semiconductor products are not designed, intended, or authorized for use as a critical component in life support systems or any FDA Class 3 medical devices or medical devices with a same or similar classification in a foreign jurisdiction or any devices intended for implantation in the human body. Should Buyer purchase or use ON Semiconductor products for any such unintended or unauthorized application, Buyer shall indemnify and hold ON Semiconductor and its officers, employees, subsidiaries, affiliates, and distributors harmless against all claims, costs, damages, and expenses, and reasonable attorney fees arising out of, directly or indirectly, any claim of personal injury or death associated with such unintended or unauthorized use, even if such claim alleges that ON Semiconductor was negligent regarding the design or manufacture of the part. ON Semiconductor is an Equal Opportunity/Affirmative Action Employer. This literature is subject to all applicable copyright laws and is not for resale in any manner.

## PUBLICATION ORDERING INFORMATION

### LITERATURE FULFILLMENT:

Literature Distribution Center for ON Semiconductor  
19521 E. 32nd Pkwy, Aurora, Colorado 80011 USA  
**Phone:** 303-675-2175 or 800-344-3860 Toll Free USA/Canada  
**Fax:** 303-675-2176 or 800-344-3867 Toll Free USA/Canada  
**Email:** [orderlit@onsemi.com](mailto:orderlit@onsemi.com)

**N. American Technical Support:** 800-282-9855 Toll Free  
USA/Canada  
**Europe, Middle East and Africa Technical Support:**  
Phone: 421 33 790 2910  
**Japan Customer Focus Center**  
Phone: 81-3-5817-1050

**ON Semiconductor Website:** [www.onsemi.com](http://www.onsemi.com)  
**Order Literature:** <http://www.onsemi.com/orderlit>  
For additional information, please contact your local  
Sales Representative