



Chipsmall Limited consists of a professional team with an average of over 10 year of expertise in the distribution of electronic components. Based in Hongkong, we have already established firm and mutual-benefit business relationships with customers from,Europe,America and south Asia,supplying obsolete and hard-to-find components to meet their specific needs.

With the principle of “Quality Parts,Customers Priority,Honest Operation,and Considerate Service”,our business mainly focus on the distribution of electronic components. Line cards we deal with include Microchip,ALPS,ROHM,Xilinx,Pulse,ON,Everlight and Freescale. Main products comprise IC,Modules,Potentiometer,IC Socket,Relay,Connector.Our parts cover such applications as commercial,industrial, and automotives areas.

We are looking forward to setting up business relationship with you and hope to provide you with the best service and solution. Let us make a better world for our industry!



Contact us

Tel: +86-755-8981 8866 Fax: +86-755-8427 6832

Email & Skype: info@chipsmall.com Web: www.chipsmall.com

Address: A1208, Overseas Decoration Building, #122 Zhenhua RD., Futian, Shenzhen, China



Features

- 4:1 Input Voltage Range
- 2.25kVDC Isolation
- UL Certified
- Efficiency up to 87%
- Ultraminiature Open Frame SMD
- No Minimum Load Required

Regulated Converters



RP15-OFW

15 Watt
Single
Output
Open Frame
SMD



Description

The RP15-OFW series are SMD open frame ultraminiature power DC/DC converters in a case half the size of industry standard 15W converters. The converters use solder ball pins to enable SMD mounting and can be reflow soldered. Despite their small size, the RP15-OFW converters are fully specified devices with output currents up to 4 Amps, no minimum load, 2250VDC isolation and low ripple/noise figures. The outputs are also fully protected against short circuits, overcurrent and overvoltage. The RP15-OFW series will find many uses in telecommunications and other demanding applications where price, board space or board height is at a premium.

Selection Guide

Part Number	Input Voltage Range [VDC]	Output Voltage [VDC]	Output Current [mA]	Input ⁽¹⁾ Current [mA]	Efficiency ⁽¹⁾ typ. [%]	Max. Capacitive Load ⁽²⁾ [µF]
RP15-243.3SOFW ⁽³⁾	9-36	3.3	4000	647	85	12000
RP15-2405SOFW ⁽³⁾	9-36	5	3000	718	87	6000
RP15-2412SOFW ⁽³⁾	9-36	12	1300	756	86	1000
RP15-2415SOFW ⁽³⁾	9-36	15	1000	727	86	660
RP15-483.3SOFW ⁽³⁾	18-75	3.3	4000	324	85	12000
RP15-4805SOFW ⁽³⁾	18-75	5	3000	359	87	6000
RP15-4812SOFW ⁽³⁾	18-75	12	1300	378	86	1000
RP15-4815SOFW ⁽³⁾	18-75	15	1000	363	86	660

Notes:

- Note1: Values at nominal input voltage and no load/full load.
 Note2: Test by minimum Vin and constant resistor load.

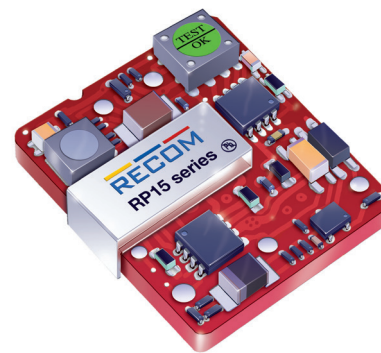

UL60950-1 Certified

Model Numbering

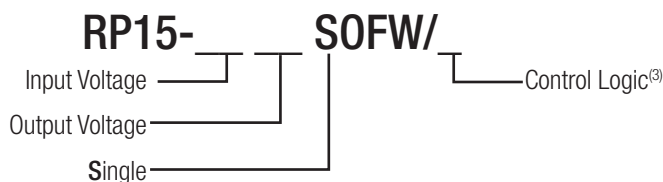

Ordering Examples

- RP15-4805SOFW = 48V 4:1 Input, 5V Output, No CTRL pin, No Trim Pin
 RP15-4805SOFW/P = 48V 4:1 Input, 5V Output, Positive Logic CTRL pin and Trim pin fitted.
 RP15-243.3SOFW/N = 24V 4:1 Input, 3.3V Output, Negative Logic CTRL pin and Trim pin fitted

Notes:

- Note3: No suffix for standard part without Trim or CTRL
 add suffix "P" for CTRL function with positive logic (1=ON, 0=OFF) and trim pin
 add suffix "N" for CTRL function with negative logic (0=ON, 1=OFF) and trim pin

Specifications measured at $T_a = 25^\circ\text{C}$, nominal input voltage, full load otherwise noted

BASIC CHARACTERISTICS					
Parameter	Condition		Min.	Typ.	Max.
Input Voltage Range	nom. $V_{in} = 24\text{V}$ nom. $V_{in} = 48\text{V}$		9DC 18VDC	24VDC 48VDC	36VDC 75VDC
Under Voltage Lockout (UVLO)	$V_{in} = 24\text{V}$	DC-DC ON DC-DC OFF		8VDC	9VDC
	$V_{in} = 48\text{V}$	DC-DC ON DC-DC OFF		16VDC	18VDC
Input Filter					Pi-Type
Input Reflected Ripple ⁽⁴⁾	nominal V_{in} and full load			30mA _{p-p}	
Input Surge Voltage	$V_{in} = 24\text{V}$, 100ms max. $V_{in} = 48\text{V}$, 100ms max.				50VDC 100VDC
Start-up time	Power up				30ms
	Remote ON/OFF				30ms
Operating Frequency Range	3.3V _{out} , 5V _{out}		315kHz	350kHz	385kHz
	12V _{out} , 15V _{out}		360kHz	400kHz	440kHz
Minimum Load	full load		0%		
Optional Output Trim ⁽⁵⁾					$\pm 10.0\%$
Ripple and Noise	20MHz bandwidth, with 1 μF M/C X7R and a 10 μF T/C			100mV _{p-p}	
Remote ON/OFF ⁽⁵⁾	Positive Logic	DC-DC ON DC-DC OFF	Open or $3.0\text{V} < V_r < 15\text{V}$ Short or $0\text{V} < V_r < 1.2\text{V}$		
	Negative Logic	DC-DC ON DC-DC OFF	Short or $0\text{V} < V_r < 1.2\text{V}$ Open or $3.0\text{V} < V_r < 15\text{V}$		
Input current of Remote pin (CTRL)				2.5mA	
			DC-DC OFF		
			DC-DC ON	-0.5mA	+1.0mA

Notes:

Note4: Simulated source impedance of 12 μH . 12 μH inductor in series with + V_{in} .

Note5: If no suffix is specified, the control and trim pins will be omitted. If fitted, the ON/OFF control function can be positive or negative logic. The pin voltage is referenced to - V_{in} .

RP15-2405S0FW

Efficiency vs. Output Current

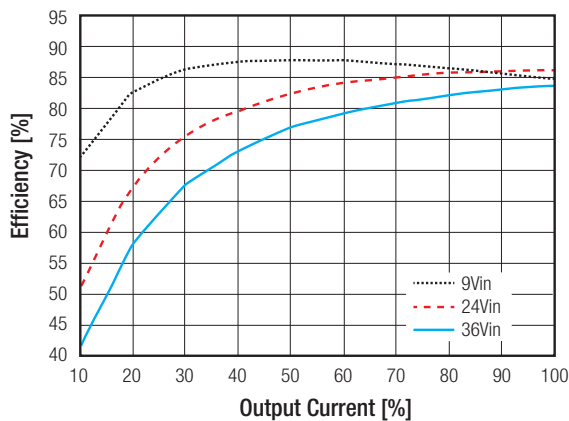

Efficiency vs. Input Voltage

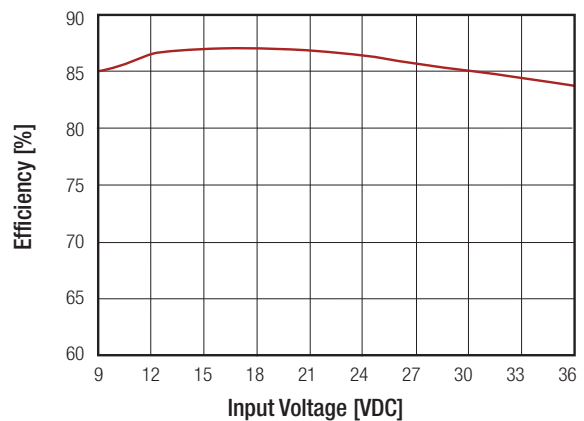

continued on next page

Specifications measured at Ta = 25°C, nominal input voltage, full load otherwise noted

RP15-4805S0FW

Efficiency vs. Output Current

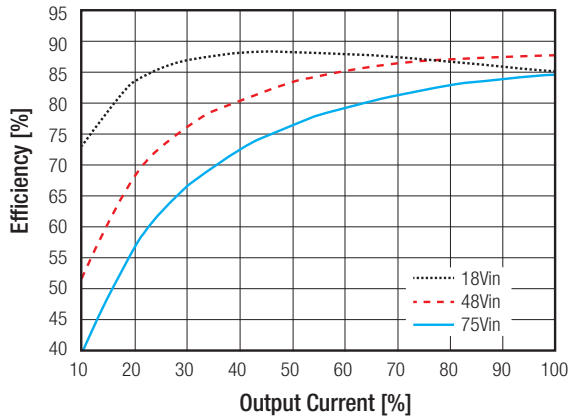

Efficiency vs. Input Voltage

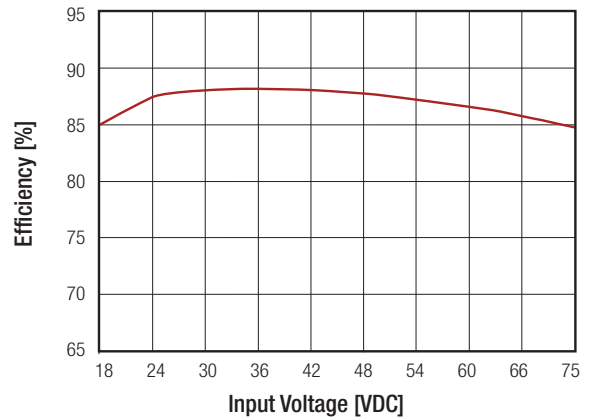

REGULATIONS

Parameter	Condition	Value
Output Voltage Accuracy		±1%
Voltage Adjustability		±10%
Line Voltage Regulation	low line to high line at full load	±0.2%
Load Voltage Regulation	0% to 100% load	±0.2%
Transient Response recovery time	25% load step change	250µs

External Output Trimming

Output Voltage Trimming

Single output Powerline Plus converters offer the feature of trimming the output voltage over a certain range around the nominal value by using external trim resistors. No general equation can be given for calculating the trim resistors, but the following trimtables give typical values for choosing these trimming resistors. If voltages between the given trim points are required, extrapolate between the two nearest given values to work out the resistor required or use a variable resistor to set the output voltage. Output can be externally trimmed by using the method shown below.

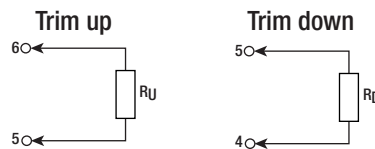

RP15-xx3.3S0F

Trim up	1	2	3	4	5	6	7	8	9	10	%
V _{out} =	3.333	3.366	3.399	3.432	3.465	3.498	3.531	3.564	3.597	3.63	Volts
R _U =	385.07	191.51	126.99	94.73	75.37	62.47	53.25	46.34	40.96	36.66	kOhms
Trim down	1	2	3	4	5	6	7	8	9	10	%
V _{out} =	3.267	3.234	3.201	3.168	3.135	3.102	3.069	3.036	3.003	2.97	Volts
R _D =	116.72	54.78	34.13	23.81	17.62	13.49	10.54	8.32	6.60	5.23	kOhms

continued on next page

Specifications measured at Ta = 25°C, nominal input voltage, full load otherwise noted

RP15-xx05S0F											
Trim up	1	2	3	4	5	6	7	8	9	10	%
Vout =	5.05	5.10	5.15	5.20	5.25	5.30	5.35	5.4	5.45	5.50	Volts
R _U =	253.45	125.70	83.12	61.82	49.05	40.53	34.45	29.89	26.34	23.50	kOhms
Trim down	1	2	3	4	5	6	7	8	9	10	%
Vout =	4.95	4.90	4.85	4.80	4.75	4.70	4.65	4.60	4.55	4.50	Volts
R _D =	248.34	120.59	78.01	56.71	43.94	35.42	29.34	24.78	21.23	18.39	kOhms
RP15-xx12S0F											
Trim up	1	2	3	4	5	6	7	8	9	10	%
Vout =	12.12	12.24	12.36	12.48	12.60	12.72	12.84	12.96	13.08	13.20	Volts
R _U =	203.22	99.06	64.33	46.97	36.56	29.61	24.65	20.93	18.04	15.72	kOhms
Trim down	1	2	3	4	5	6	7	8	9	10	%
Vout =	11.88	11.76	11.64	11.52	11.40	11.28	11.16	11.04	10.92	10.8	Volts
R _D =	776.56	380.72	248.78	182.81	143.22	116.83	97.98	83.85	72.85	64.06	kOhms
RP15-xx15S0F											
Trim up	1	2	3	4	5	6	7	8	9	10	%
Vout =	15.15	15.3	15.45	15.60	15.75	15.90	16.05	16.20	16.35	16.50	Volts
R _U =	161.56	78.22	50.45	36.56	28.22	22.67	18.70	15.72	13.41	11.56	kOhms
Trim down	1	2	3	4	5	6	7	8	9	10	%
Vout =	14.85	14.70	14.55	14.40	14.25	14.10	13.95	13.80	13.65	13.50	Volts
R _D =	818.22	401.56	262.67	193.22	151.56	123.78	103.94	89.06	77.48	68.22	kOhms

PROTECTIONS		
Parameter	Condition	Value
Short Circuit Protection (SCP)		continuous, automatic recovery
Over Voltage Protection (OVP)	Zener Diode Clamp	3.3Vout 5Vout 12Vout 15Vout 3.7 - 5.4V 5.6 - 7.0V 13.8 - 17.5V 16.8 - 20.5V
Over Load Protection (OLP)	% of lout rated, Hiccup mode	150% typ.
Isolation Voltage	I/P to O/P	2.25kVDC/1 minute
Isolation Resistance	500VDC	1GΩ min.
Isolation Capacitance		1500pF typ.
<p>Notes: Note6: This power module is not internally fused. An input line fuse must always be used.</p>		

Specifications measured at Ta = 25°C, nominal input voltage, full load otherwise noted

ENVIRONMENTAL		
Parameter	Condition	Value
Reflow Soldering Process		IPC J-STD-020D
Moisture sensitivity level (MSL)		IPC J-STD-03B level 2a
Operating Temperature Range	without derating with derating	-40°C to +70°C -40°C to +120°C
Temperature Coefficient		±0.02%/°C max.
Thermal Impedance	Natural convection (20LFM)	18.2°C/Watt
Operating Humidity		5% - 95% RH
Thermal Shock		MIL-STD-810F
Vibration		MIL-STD-810F
MTBF	MIL-HDBK-217F Bellcore TR-NWT-000332 ⁽⁷⁾	2444 x 10 ³ hours 1322 x 10 ³ hours

Derating Graph⁽⁸⁾

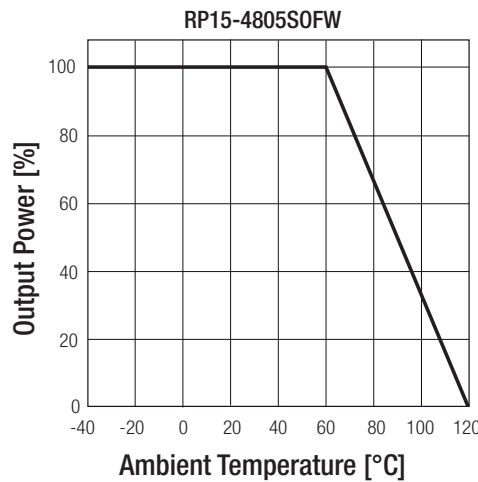

Notes:

- Note7: BELLCORE TR-NWT-000332. Case I: 50% Stress, Temperature at 40°C. MIL-HDBK 217F Notice 2. Ta = 25°C, full load, (Ground Benign, controlled environment).
- Note8: Derating graphs are valid only for the shown part numbers. If you need detailed derating-information about a part-number not shown here please contact our technical support service at techsupportAT@recom-power.com

SAFETY AND CERTIFICATIONS		
Certificate Type (Safety)	Report / File Number	Standard
UL General Safety	E196683	UL60950-1 1st Ed.: 2003 C22.2 No. 60950 1st. Ed.: 2003
EMC Compliance	Condition	Standard / Criterion
EMI Standard ⁽⁹⁾	with external filter	EN55022, Class A, Class B
Radiated Immunity	10 V/m	EN61000-4-3, Criteria A
Fast Transient ⁽¹⁰⁾	±2kV	EN61000-4-4, Criteria A
Surge ⁽¹⁰⁾	±1kV	EN61000-4-5, Criteria A
Conducted Immunity	10 Vr.m.s	EN61000-4-6, Criteria A

Notes:

- Note9: The standard modules meet EMI Class A or Class B with external components, see filter suggestions below.
- Note10: An external input filter capacitor is required if the module has to meet EN61000-4-4, EN61000-4-5. The filter capacitor Recom suggests: Nippon chemi-con KY series, 220µF/100V.

continued on next page

Specifications measured at Ta = 25°C, nominal input voltage, full load otherwise noted

EMI Filtering Class A

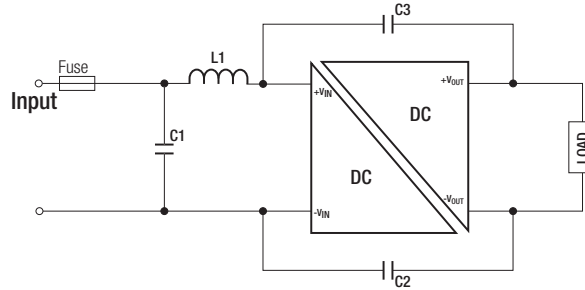

MODEL	C1	C2/C3	L1
RP15-24xxSOFW	6.8µF/50V 1812 MLCC	470pF/3kV 1808 MLCC	10µH 2.6A 0.04Ω 0705 SMD Inductor ref.: WE 744787330
RP15-48xxSOFW	2.2µF/100V 1812 MLCC	470pF/3kV 1808 MLCC	18µH 1.6A 0.1Ω 0705 SMD Inductor ref.: WE 744053180

EMI Filtering Class B

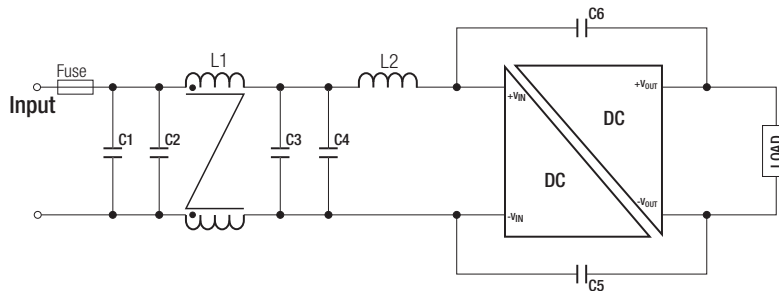

MODEL	C1	C2	C3/C4	C5/C6	L1	L2
RP15-24xxSOFW	N/A	6.8µF/50V 1812 MLCC	6.8µF/50V 1812 MLCC	470pF/3kV 1808 MLCC	CMC: 145µH ref.: WE 7482210002 ref.: CMC-07	10µH 2.6A 0.04Ω 0705 SMD Inductor ref.: WE 744787330
RP15-48xxSOFW	2.2µF/100V 1812 MLCC	2.2µF/100V 1812 MLCC	2.2µF/100V 1812 MLCC	470pF/3kV 1808 MLCC	CMC: 325µH ref.: WE 744290321 ref.: CMC-06	33µH 1.2A 0.13Ω 0504 SMD Inductor ref.: WE 744787100

DIMENSIONS and PHYSICAL CHARACTERISTICS

Parameter	Type	Value
Material	Base	FR4 PCB
Package Dimensions (LxWxH)		27.9 x 23.9 x 8.5mm
Package Weight		10.5g

continued on next page

Specifications measured at Ta = 25°C, nominal input voltage, full load otherwise noted

Dimension Drawing (mm)

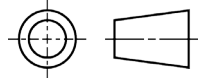
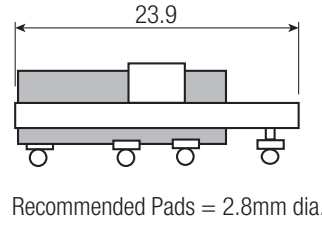
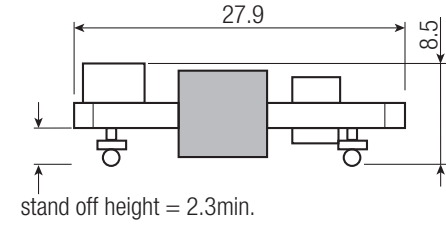

Pin Connections

Pin #	Single	/P or /N
1	+Vin	+Vin
2	-Vin	-Vin
3	no pin	CTRL
4	+Vout	+Vout
5	no pin	Trim
6	-Vout	-Vout

Pin Pitch Tolerance ±0.25mm
PCB Tolerance ±0.5mm
SMD Pin Pitch Tolerance ±0.25mm
X.X ±0.5mm
X.XX ±0.25mm

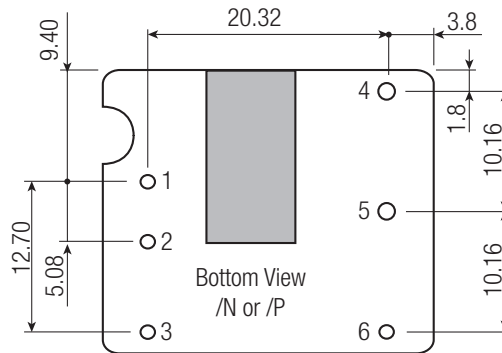
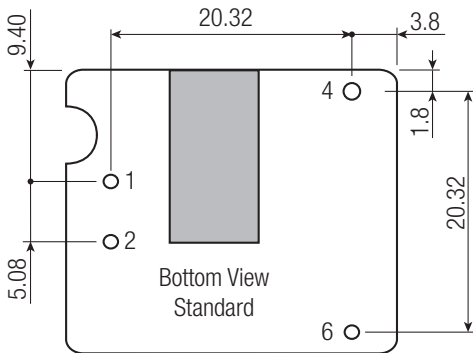

PACKAGING INFORMATION		
Parameter	Type	Value
Packaging Quantity		20pcs.
Storage Temperature Range		-55°C to +125°C
Storage Humidity		5% - 95% RH

The product information and specifications are subject to change without prior notice. RECOM products are not authorized for use in safety-critical applications (such as life support) without RECOM's explicit written consent. A safety-critical application is defined as an application where a failure of a RECOM product may reasonably be expected to endanger or cause loss of life, inflict bodily harm or damage property. The buyer shall indemnify and hold harmless RECOM, its affiliated companies and its representatives against any damage claims in connection with the unauthorized use of RECOM products in such safety-critical applications.