



Chipsmall Limited consists of a professional team with an average of over 10 year of expertise in the distribution of electronic components. Based in Hongkong, we have already established firm and mutual-benefit business relationships with customers from,Europe,America and south Asia,supplying obsolete and hard-to-find components to meet their specific needs.

With the principle of “Quality Parts,Customers Priority,Honest Operation,and Considerate Service”,our business mainly focus on the distribution of electronic components. Line cards we deal with include Microchip,ALPS,ROHM,Xilinx,Pulse,ON,Everlight and Freescale. Main products comprise IC,Modules,Potentiometer,IC Socket,Relay,Connector.Our parts cover such applications as commercial,industrial, and automotives areas.

We are looking forward to setting up business relationship with you and hope to provide you with the best service and solution. Let us make a better world for our industry!



## Contact us

Tel: +86-755-8981 8866 Fax: +86-755-8427 6832

Email & Skype: info@chipsmall.com Web: www.chipsmall.com

Address: A1208, Overseas Decoration Building, #122 Zhenhua RD., Futian, Shenzhen, China



# Features

# Regulated Converters

- 4:1 Wide Input Voltage Range
- 1.6kVDC Isolation
- UL, IEC/EN Certified & EN50155 Pending
- Efficiency up to 89%
- OVP, OCP & OTP
- +105°C max Case Temperature

## Description

The RPA30-AW series are high power density, wide input voltage range 30W DC/DC converters in an industry standard 1"x1" case size. Despite their small size, the RPA30-AW converters are fully specified devices with output currents up to 7.5Amps, up to 89% efficiency, no minimum load, 1600VDC isolation, tight regulation and low ripple/noise figures. The outputs are also fully protected against over-temperature, short circuits, overcurrent and overvoltage and the single output version offers a ±10% trim range. A heatsink option is available to extend the operating temperature range. The converters are UL and EN50155 pending and will find many uses in railway and industrial applications where board space is at a premium.

## Selection Guide

Part Number	Input Voltage Range [VDC]	Output Voltage [VDC]	Output Current [mA]	Input <sup>(1)</sup> Current [mA]	Efficiency <sup>(1)</sup> typ. [%]	Max. Capacitive Load [µF]
RPA30-243.3SAW <sup>(2,3)</sup>	9-36	3.3	7500	1172	88	10000
RPA30-2405SAW <sup>(2,3)</sup>	9-36	5	6000	1404	89	10000
RPA30-2412SAW <sup>(2,3)</sup>	9-36	12	2500	1420	88	1000
RPA30-2415SAW <sup>(2,3)</sup>	9-36	15	2000	1420	88	1000
RPA30-2412DAW <sup>(2,3)</sup>	9-36	±12	±1250	1420	88	±1000
RPA30-2415DAW <sup>(2,3)</sup>	9-36	±15	±1000	1420	88	±680

### Notes:

Note1: Tested at nominal Vin, full load and at +25°C ambient

## Model Numbering

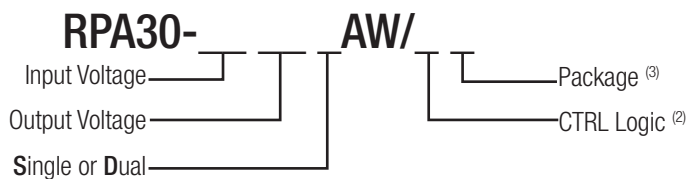

### Ordering Examples

- RPA30-243.3SAW = 24V Input, 3.3V Output, Single, no CTRL pin
- RPA30-2405SAW/P = 24V Input, 5V Output, Single, Pos. CTRL function
- RPA30-2415SAW-HC = 24V Input, 15V Output, Single, no CTRL pin, glued Heat-sink
- RPA30-2415DAW/N-HC = 24V Input, 15V Output, Dual, Neg. CTRL function, glued Heat-sink

### Notes:

- Note2: part without suffixes is without CTRL pin, trim pin fitted  
add suffix "P" for positive CTRL function (1=ON, 0=OFF), trim pin fitted  
add suffix "N" for negative CTRL function (0=ON, 1=OFF), trim pin fitted  
trim pin is only available for single outputs
- Note3: add suffix "-HC" for glued Heat-sink (compatible with all other suffixes)

**RECOM**  
DC/DC Converter

## RPA30-AW

30 Watt

1"x1"

Single & Dual Output



C **UL** US  
E224736

UL60950-1 Certified  
IEC/EN60950 Certified  
EN50155 Pending

**Specifications** measured @ $t_a = 25^\circ\text{C}$ , resistive load, nominal  $V_{in}$  and rated  $I_{out}$  unless otherwise noted

BASIC CHARACTERISTICS				
Parameter	Condition	Min.	Typ.	Max.
Internal Input Filter				Pi-Type
Input Voltage Range		9VDC	24VDC	36VDC
Input Surge Voltage	100ms max.			50VDC
Quiescent Current				
Start-up time	Power up CTRL ON/OFF		8ms	16ms
Internal Operating Frequency			550kHz	
Minimum Load		0%		
Ripple and Noise	20MHz BW, 10 $\mu\text{F}$ tantalum capacitor and 1 $\mu\text{F}$ ceramic capacitor		50mVp-p	
Under Voltage Lockout (UVLO)	DC-DC ON	8VDC	8.5VDC	9VDC
	DC-DC OFF	7VDC	7.5VDC	8VDC
ON/OFF Control	Positive Logic DC-DC ON DC-DC OFF			Open or $2.4 < V_r < 10\text{VDC}$ Short or $0 < V_r < 0.8\text{VDC}$
	Negative Logic DC-DC ON DC-DC OFF			Short or $0 < V_r < 0.8\text{VDC}$ Open or $2.4 < V_r < 10\text{VDC}$
Input current of CTRL pin			6mA	
Output Voltage Trimming	Single Outputs	-10%		+10%

**RPA30-243.3SAW**

Efficiency vs. Output Current

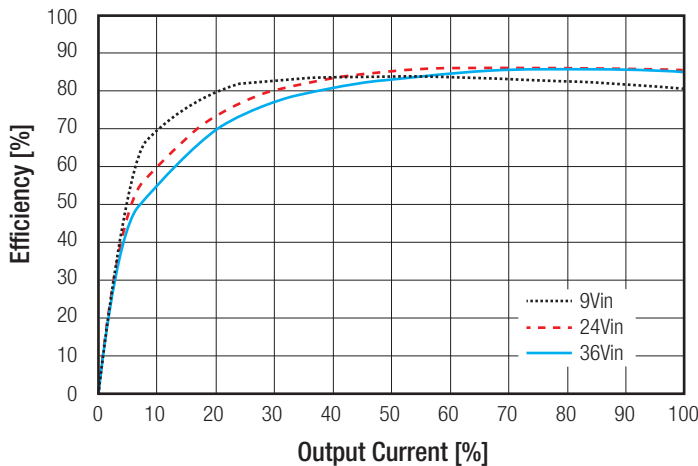

Power Dissipation vs Output Current

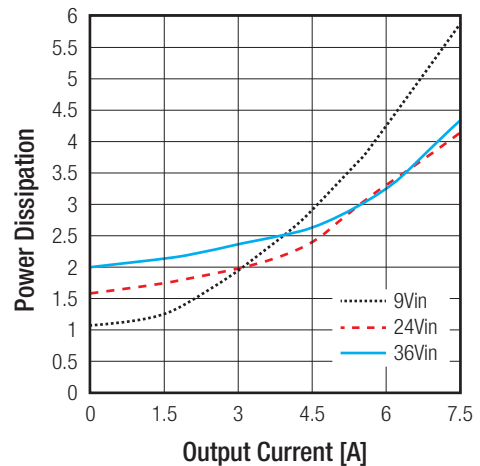

**RPA30-2405SAW**

Efficiency vs. Output Current

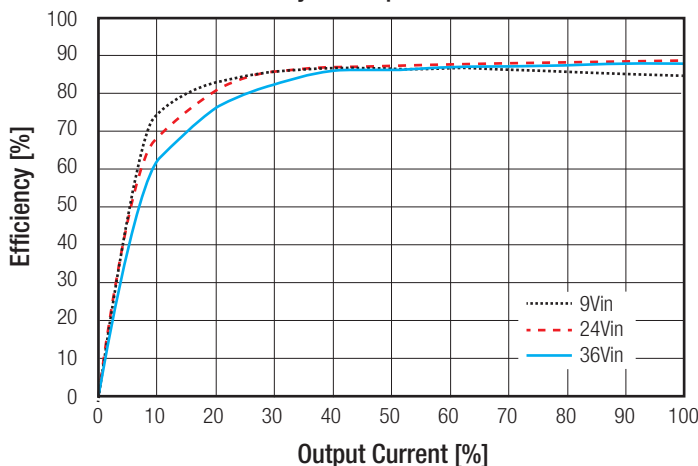

Power Dissipation vs Output Current

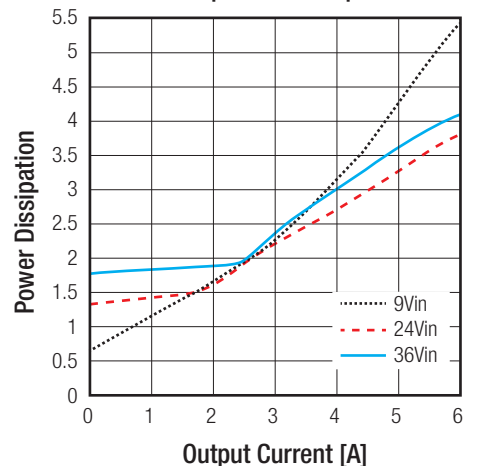

continued on next page

Specifications measured @ $t_a = 25^\circ\text{C}$ , resistive load, nominal  $V_{in}$  and rated  $I_{out}$  unless otherwise noted

**RPA30-2412SAW**

Efficiency vs. Output Current

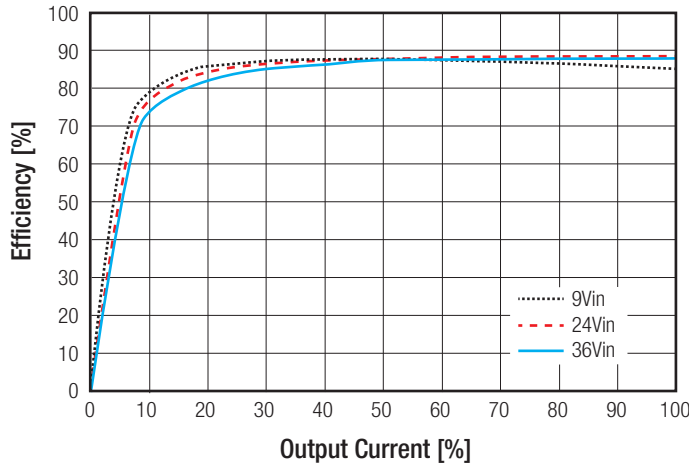

Power Dissipation vs Output Current

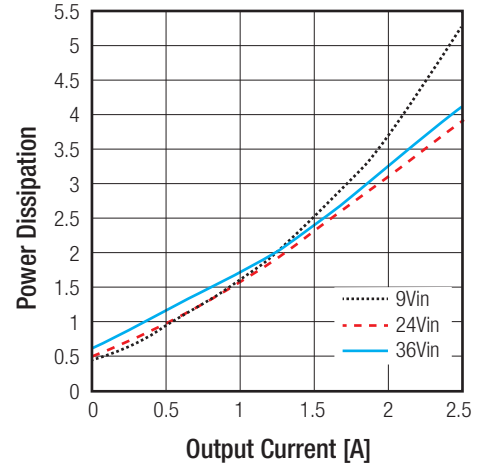

**RPA30-2415SAW**

Efficiency vs. Output Current

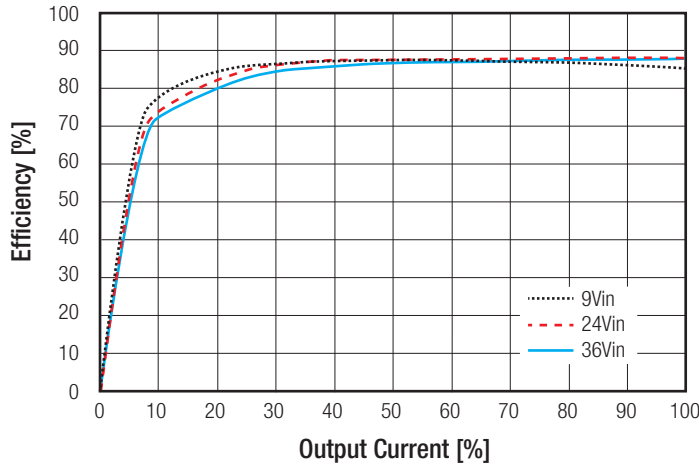

Power Dissipation vs Output Current

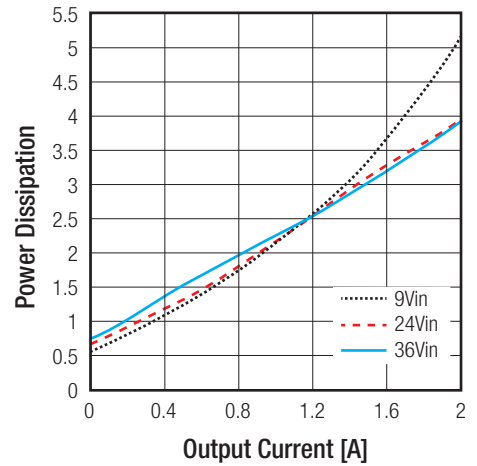

**RPA30-2412DAW**

Efficiency vs. Output Current

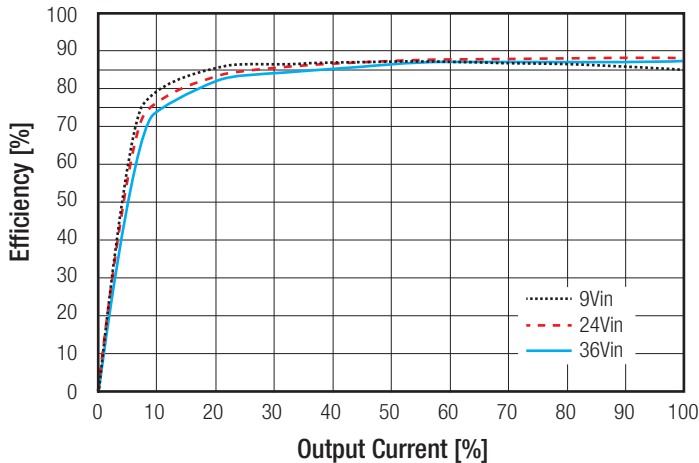

Power Dissipation vs Output Current

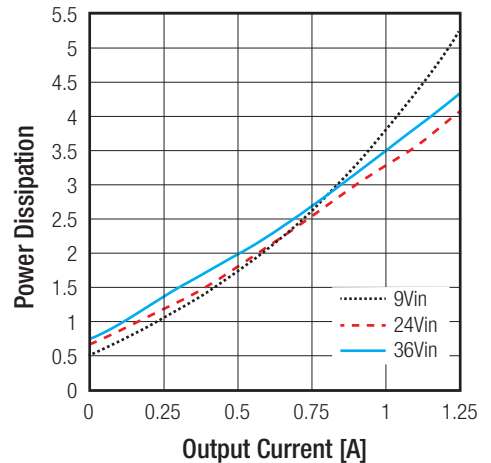

continued on next page

Specifications measured @ $t_a = 25^\circ\text{C}$ , resistive load, nominal  $V_{in}$  and rated  $I_{out}$  unless otherwise noted

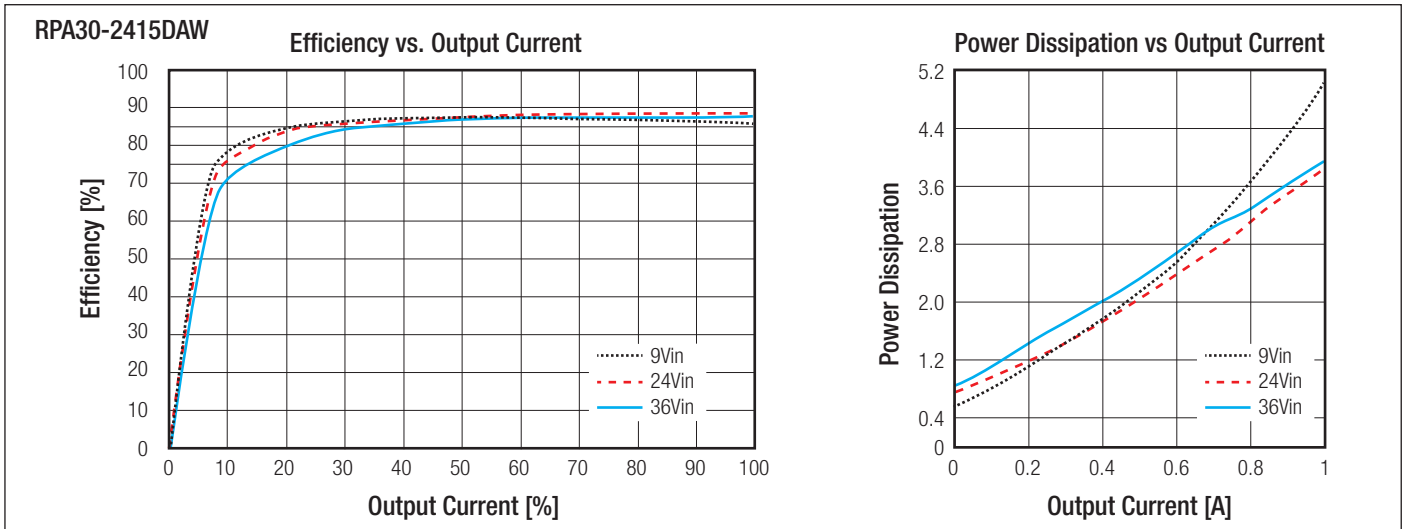

## OUTPUT TRIM

### Output Voltage Trimming

RPA30-AW converters offer the feature of trimming the output voltage over a certain range around the nominal value by using external trim resistors. The values for trim resistors shown in trim tables below are according to standard E96 values; therefore, the specified voltage may slightly vary.

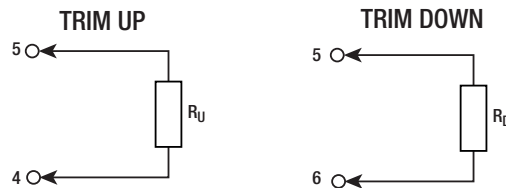

### RPA30-243.3SAW

Trim up	1	2	3	4	5	6	7	8	9	10	%
$V_{out} =$	3.33	3.36	3.39	3.43	3.46	3.49	3.53	3.56	3.59	3.63	Volts
$R_U =$	402	169	100	75	47.5	34.8	26.1	17.8	12.1	8.06	kOhms
Trim down	1	2	3	4	5	6	7	8	9	10	%
$V_{out} =$	3.27	3.23	3.20	3.17	3.14	3.10	3.07	3.04	3.0	2.97	Volts
$R_D =$	402	191	113	75	52.3	39.2	26.7	20	12.1	8.06	kOhms

### RPA30-2405SAW

Trim up	1	2	3	4	5	6	7	8	9	10	%
$V_{out} =$	5.05	5.10	5.15	5.20	5.25	5.30	5.35	5.40	5.45	5.50	Volts
$R_U =$	604	243	147	95.3	68.1	39.2	34.8	22.1	15	8.06	kOhms
Trim down	1	2	3	4	5	6	7	8	9	10	%
$V_{out} =$	4.95	4.90	4.85	4.80	4.75	4.70	4.65	4.60	4.55	4.50	Volts
$R_D =$	604	287	169	124	105	78.7	54.9	39.2	15	0.5	kOhms

### RPA30-2412SAW

Trim up	1	2	3	4	5	6	7	8	9	10	%
$V_{out} =$	12.12	12.24	12.36	12.48	12.6	12.72	12.84	12.96	13.08	13.20	Volts
$R_U =$	604	267	162	105	75	499	40.2	24.9	18.2	10	kOhms
Trim down	1	2	3	4	5	6	7	8	9	10	%
$V_{out} =$	11.88	11.76	11.64	11.52	11.40	11.28	11.16	11.04	10.92	10.80	Volts
$R_D =$	750	309	200	124	90.9	64.9	45.3	32.4	20	12.1	kOhms

continued on next page

**Specifications** measured @ $t_a = 25^\circ\text{C}$ , resistive load, nominal  $V_{in}$  and rated  $I_{out}$  unless otherwise noted

RPA30-2415SAW											
Trim up	1	2	3	4	5	6	7	8	9	10	%
$V_{out} =$	15.15	15.30	15.45	15.60	15.75	15.90	16.05	16.20	16.35	16.50	Volts
$R_u =$	1000	243	200	130	90.9	61.9	40.2	30.1	24.9	10	kOhms
Trim down	1	2	3	4	5	6	7	8	9	10	%
$V_{out} =$	14.85	14.70	14.55	14.40	14.25	14.10	13.95	13.80	13.65	13.50	Volts
$R_d =$	1000	348	210	140	95.3	68.1	45.3	30.1	18.2	8.06	kOhms

REGULATION			
Parameter	Condition	Value	
Output Accuracy	Single & Dual	$\pm 2.0\%$ max.	
Line Regulation	low line to high line	Single	$\pm 0.2\%$ max.
		Dual	$\pm 0.5\%$ max.
Load Regulation	3.3 $V_{out}$	$\pm 0.3\%$	
	5 $V_{out}$	$\pm 0.2\%$	
	12 $V_{out}$ , 15 $V_{out}$	$\pm 0.1\%$	
	$\pm 12V_{out}$ , $\pm 15V_{out}$	$\pm 1.0\%$	
Cross Regulation	asymmetrical 25% $\leftrightarrow$ 100% load	$\pm 3.0\%$ max.	
Transient Response	50-75%, full load, 0.1A/ $\mu$ s	$\pm 3.0\%$ $V_{out}$ typ.	
	25% load step change	250 $\mu$ s typ.	

PROTECTION		
Parameter	Condition	Value
Short Circuit Protection (SCP)	below 100m $\Omega$	continuous, auto recovery
Over Voltage Protection (OVP)		115%-150% Output Voltage, Hiccup, auto recovery
Over Current Protection (OCP)		110%-160% Output Current, Hiccup
Over Temperature Protection (OTP)		+115 $^\circ\text{C} \pm 5^\circ\text{C}$
Isolation Voltage <sup>(6)</sup>	I/P to O/P	tested for 1 minute
Isolation Resistance		10M $\Omega$ min.
Isolation Capacitance		1100pF typ.
Insulation Grade		basic
<b>Notes:</b>		
Note4: An input fuse is required if the mains supply is not over-current protected. Recommended fuse: 4A slow blow type.		
Note5: For repeat Hi-Pot testing, reduce the time and/or the test voltage.		

ENVIRONMENTAL		
Parameter	Condition	Value
Operating Temperature Range <sup>(6)</sup>		-40 $^\circ\text{C}$ to [refer to thermal calculation]
Maximum Case Temperature		+105 $^\circ\text{C}$
Temperature Coefficient		0.02%/ $^\circ\text{C}$
Thermal Impedance		please refer to table 1
Operating Altitude		2000m
Operating Humidity		95% RH
MTBF		5888 x 10 <sup>3</sup> hours

continued on next page

**Specifications** measured @ $t_a = 25^\circ\text{C}$ , resistive load, nominal  $V_{in}$  and rated  $I_{out}$  unless otherwise noted

Table 1: Thermal Impedance

airflow [m/s]	without Heatsink		with Heatsink	
	R <sub>th</sub> without PCB [°C/W]	R <sub>th</sub> with PCB <sup>(6)</sup> [°C/W]	R <sub>th</sub> without PCB [°C/W]	R <sub>th</sub> with PCB <sup>(6)</sup> [°C/W]
0.1	17.8	12.5	16.0	11.3
0.2	16.0	11.2	14.4	10.1
0.5	14.0	9.7	12.6	8.7
1.0	10.0	7.1	9.0	6.4
1.5	8.3	5.8	7.5	5.2
2.0	6.3	4.4	5.7	4.0

**Notes:**

Note6: Test PCB:160x100mm105µm (Eurocard), double layer

**Thermal Calculation**

choose your model:

**RPA30-2405SAW (with PCB <sup>(6)</sup>)**

- Load conditions in application (e.g. 50%)
- Airflow conditions in application (e.g. 0.5m/s)
- use R<sub>th</sub> from Table1 (9.7°C/W)

Calculation:

$$I_{out} = 50\%$$

$$R_{th} = 9.7^\circ\text{C/W}$$

$$P_{DISS} = 2.2\text{W}$$

$$T_{CASEmax} = 105^\circ\text{C}$$

$$T_{OVER} = R_{th} \times P_{Dis} = 9.7^\circ\text{C/W} \times 2.2\text{W} = \mathbf{21.3^\circ\text{C}}$$

$$T_{AMBmax} = T_{CASEmax} - T_{OVER} = 105^\circ\text{C} - 21.3^\circ\text{C} = \mathbf{83.7^\circ\text{C}}$$

choose your model:

**RPA30-2405SAW-HC (with PCB <sup>(6)</sup>)**

- Load conditions in application (e.g. 50%)
- Airflow conditions in application (e.g. 0.5m/s)
- use R<sub>th</sub> from Table1 (8.7°C/W)

Calculation:

$$I_{out} = 50\%$$

$$R_{th} = 8.7^\circ\text{C/W}$$

$$P_{DISS} = 2.2\text{W}$$

$$T_{CASEmax} = 105^\circ\text{C}$$

$$T_{OVER} = R_{th} \times P_{Dis} = 8.7^\circ\text{C/W} \times 2.2\text{W} = \mathbf{19.1^\circ\text{C}}$$

$$T_{AMBmax} = T_{CASEmax} - T_{OVER} = 105^\circ\text{C} - 19.1^\circ\text{C} = \mathbf{85.9^\circ\text{C}}$$

RPA30-2405SAW

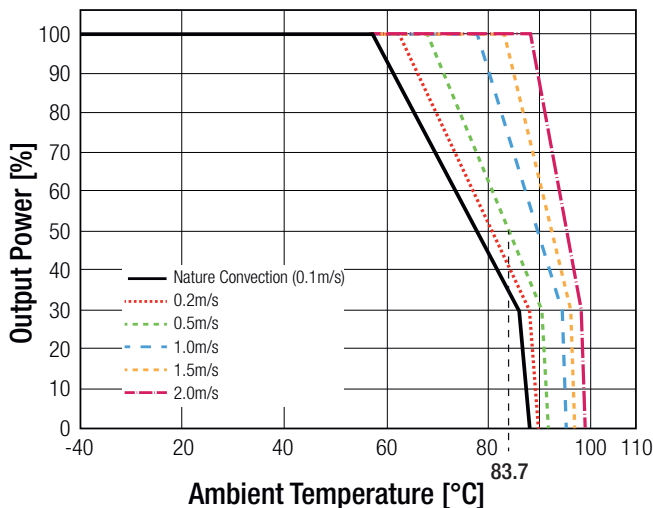

RPA30-2405SAW-HC

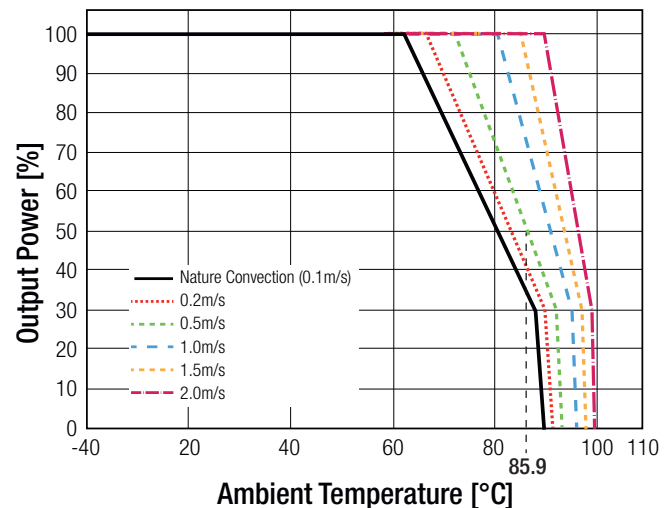

**SAFETY AND CERTIFICATIONS**

Certificate Type (Safety)	Report / File Number	Standard
Information Technology Equipment, General Requirements for Safety	E224736-A39 + A40	UL60950-1, 2nd Edition, 2014 CSA C22.2 No. 60950, 2nd Edition, 2014
IEC/EN Information Technology Equipment - General Requirements for Safety (CB Scheme)	E224736-A39-CB + A40-CB	IEC60950-1, 2nd Edition, 2005 + AM2, 2013 EN60950-1, 1st Edition, 2006 + AM2, 2013
EN Information Technology Equipment - General Requirements for Safety (LVD Directive)		EN60950-1, 1st Edition, 2006
Railway Applications - Electrical Equipment used on rolling stock	pending	EN50155, 1st Edition, 2007

continued on next page

**Specifications** measured @ $t_a = 25^\circ\text{C}$ , resistive load, nominal  $V_{in}$  and rated  $I_{out}$  unless otherwise noted

EMC Compliance (designed to meet)	Condition	Standard / Criterion
Information technology equipment - Radio disturbance characteristics Limits and methods of measurement	with external filter	EN55022, Class A, 2010

**EMI Filtering according to EN50121-3-2 and EN55022 Class A**

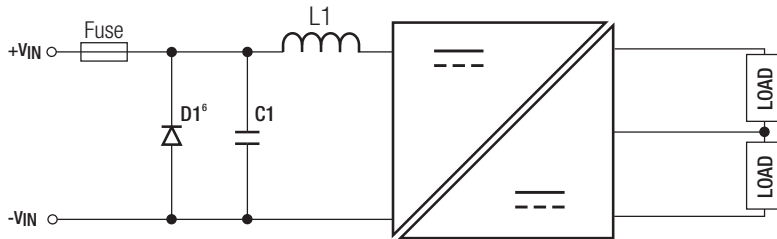

C1	L1
47 $\mu\text{F}$ /50V electrolytic capacitor	1 $\mu\text{H}$ Choke

**Notes:**

Note7: Diode is only needed for EN50155.

**DIMENSIONS and PHYSICAL CHARACTERISTICS**

Parameter	Type	Value
Material	Case	Al Alloy, anodize black
	Baseplate	non-conductive FR4
	Potting	Silicone
Package Dimensions (LxWxH)	without Heat-sink	25.4 x 25.4 x 10.2mm
	with Heat-sink	25.4 x 25.4 x 16.8mm
Package Weight	without Heat-sink	17g typ.
	with Heat-sink	21g typ.

**Dimension Drawing (mm)**

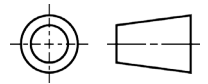
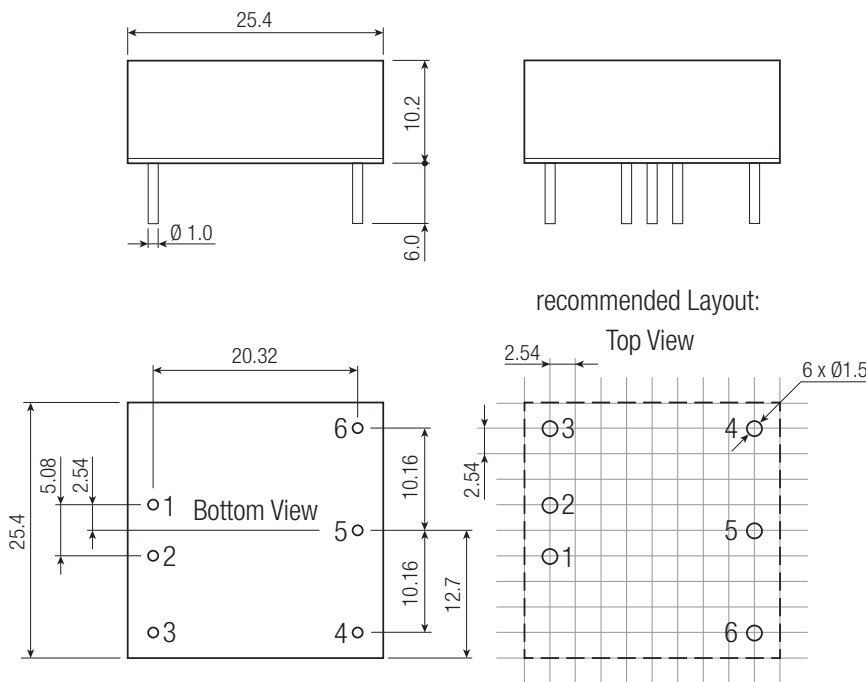

**Pin Connections**

Pin #	Single	Dual
1	+Vin	+Vin
2	-Vin	-Vin
3	CTRL <sup>(2)</sup>	CTRL <sup>(2)</sup>
4	-Vout	-Vout
5	Trim	Com
6	+Vout	+Vout

Pin Pitch Tolerance  $\pm 0.25\text{mm}$   
Pin dimension tolerance  $\pm 0.1\text{mm}$   
XX.X  $\pm 0.5\text{mm}$   
XX.XX  $\pm 0.25\text{mm}$

continued next page



**Specifications** measured @ $t_a = 25^\circ\text{C}$ , resistive load, nominal  $V_{in}$  and rated  $I_{out}$  unless otherwise noted

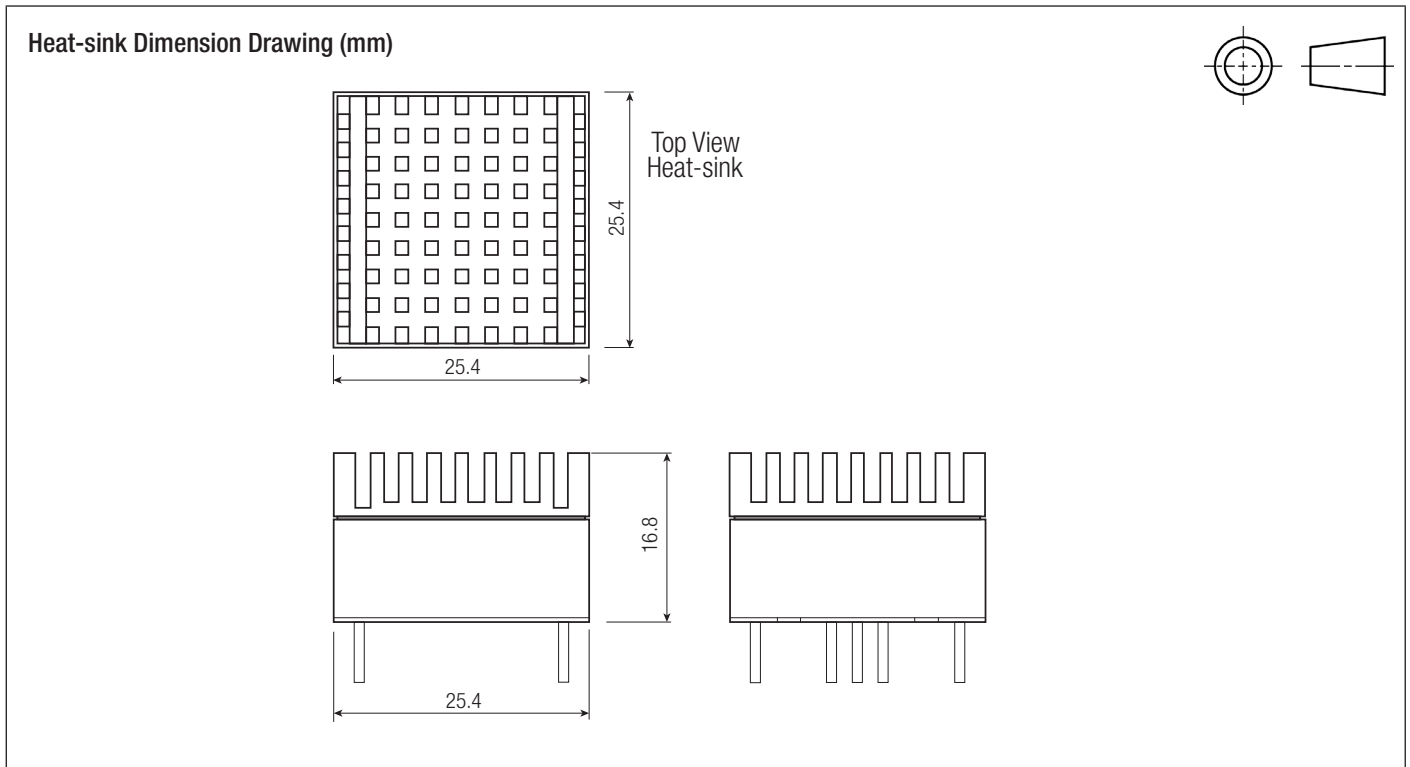

**PACKAGING INFORMATION**

Parameter	Type		Value
	without Heat-sink	with Heat-sink	
Packaging Dimensions (LxWxH)		tube	285.0 x 27.6 x 19.0mm
			285.0 x 27.6 x 25.8mm
Packaging Quantity			10pcs
Storage Temperature Range			-55°C to +125°C
Storage Humidity			5% - 95% RH