



Chipsmall Limited consists of a professional team with an average of over 10 year of expertise in the distribution of electronic components. Based in Hongkong, we have already established firm and mutual-benefit business relationships with customers from,Europe,America and south Asia,supplying obsolete and hard-to-find components to meet their specific needs.

With the principle of "Quality Parts,Customers Priority,Honest Operation,and Considerate Service",our business mainly focus on the distribution of electronic components. Line cards we deal with include Microchip,ALPS,ROHM,Xilinx,Pulse,ON,Everlight and Freescale. Main products comprise IC,Modules,Potentiometer,IC Socket,Relay,Connector.Our parts cover such applications as commercial,industrial, and automotives areas.

We are looking forward to setting up business relationship with you and hope to provide you with the best service and solution. Let us make a better world for our industry!



## Contact us

Tel: +86-755-8981 8866 Fax: +86-755-8427 6832

Email & Skype: info@chipsmall.com Web: www.chipsmall.com

Address: A1208, Overseas Decoration Building, #122 Zhenhua RD., Futian, Shenzhen, China



GlobTek, Inc.  
 www.globtek.com  
 186 Veterans Drive,  
 Northvale, NJ 07647  
 Tel. (201) 784-1000  
 Fax (201) 784-0111

Drawing Title: GTM96300-2307.5-1.55-R2, Medical/ITE/Household use Power Supply, Efficiency Level: VI, Case Color/Style: GlobTek Black, Wall Plug-in+Desktop Combination, Regulated Switchmode AC-DC Power Supply AC Adaptor, Input Rating: 100-240V~, 50-60 Hz, IEC 60320/C8 w/ Wall Blades Option , Output Rating: 23W, 5.95V@3.86A, Output Configuration: 1200 mm, 16/2 Cond, Round Black, T-plug system, Ferrite: None, GlobTek Black, GT Cord # C4257, Pin Out: Polarity Configuration T00 All plugs are Medical Grade, Locking, Polarized once installed, and single use only. Product demonstration link: <https://en.globtek.com/news/t00-changeable-output-plug-system-for-power-supplies> MOLDED CONNECTORS AVAILABLE, Blades/Input Cord: R-Series 1-15P North America, Approvals: CB CB ETL ETL ETL 230V CoC Tier 2 EAC cETLus cETLus cETLus FCC CAN ICES-3 cETLus 60601-1 3rd S-Mark Double Insulation CCC CE CE CB S-Mark CE China RoHS Level VI RoHS Ukraine VCCI WEEE PSE PSE PSE CB

Model No. GTM96300-2307.5-1.55-R2

Part No./Ordering No. RR9KB3865T00NAIMR6B

Rev B

## REVISION HISTORY

REV	DESCRIPTION	SUB	DATE	APPROVED
B	Update part number from RR9KB3750T00NAIMR6B to RR9KB3865T00NAIMR6B	rchiu	07/05/2017	QA
A1	Update engineering model from GTM96300-2307.5-1.5-R2 to GTM96300-2307.5-1.55-R2 Update out voltage from 6V to 5.95V	rchiu	05/22/2017	QA
A	Initial Release	jwarn	05/02/2017	QA

In Addition to GlobTek Inc.'s renewed ISO9001:2008 - Quality Management System Certification, GlobTek Inc. is now certified to:

ISO13485:2003 - Medical Devices Quality Management System Certification

ISO14001:2004 - Environmental Management System Certification

ISO Certificates are available online at <http://www.globtek.com/iso-certificates/>

### Customer Approval of Specification:

Please approve, sign and send back to GlobTek so we can complete order processing.

A delay in receipt of this form will delay delivery schedule.

Company Name:

Customer P/N:

Quote Number:

Date:

Authorized Representative Name:

Authorized Representative Signature:

The acceptance of this specification and use of the product described in this document indicates the acceptance and binding of the customer to Globtek terms and conditions, which supersede all other agreements, terms, and conditions (<http://en.globtek.com/terms-and-conditions/>).

### Footnote:

GlobTek Inc. will not be liable for the safety and performance of these power supplies if unauthorized access and repair occurs. End user should consult applicable UL, CSA or EN standards for proper installation instruction.

### Limitation of Use:

GlobTek product are not authorized for use as mission critical components in life support hazardous environment, nuclear or aircraft applications without prior written approval from the CEO of GlobTek Inc.

Contents of this document are subject to change without prior notice.

GTM96300-2307.5-1.55-R2, 23W, 5.95V@3.86A, Wall Plug-in+Desktop Combination, Regulated Switchmode AC-DC Power Supply AC Adaptor

PROPRIETARY INFORMATION

PROPRIETARY OF GLOBTEK, INC. ANY REPRODUCTION, DISCLOSURE OR USE OF THIS DRAWING, IN WHOLE OR IN PART, IS HEREBY PROHIBITED EXCEPT AS SPECIFIED IN WRITING BY GLOBTEK, INC.

GlobTek, Inc.  
 www.globtek.com  
 186 Veterans Drive,  
 Northvale, NJ 07647  
 Tel. (201) 784-1000  
 Fax (201) 784-0111

Drawing Title: GTM96300-2307.5-1.55-R2, Medical/ITE/Household use Power Supply, Efficiency Level: VI, Case Color/Style: GlobTek Black, Wall Plug-in+Desktop Combination, Regulated Switchmode AC-DC Power Supply AC Adaptor, Input Rating: 100-240V~, 50-60 Hz, IEC 60320/C8 w/ Wall Blades Option , Output Rating: 23W, 5.95V@3.86A, Output Configuration: 1200 mm, 16/2 Cond, Round Black, T-plug system, Ferrite: None, GlobTek Black, GT Cord # C4257, Pin Out: Polarity Configuration T00 All plugs are Medical Grade, Locking, Polarized once installed, and single use only. Product demonstration link: <https://en.globtek.com/news/t00-changeable-output-plug-system-for-power-supplies> MOLDED CONNECTORS AVAILABLE, Blades/Input Cord: R-Series 1-15P North America, Approvals: CB CB ETL ETL ETL 230V CoC Tier 2 EAC cETLus cETLus cETLus FCC CAN ICES-3 cETLus 60601-1 3rd S-Mark Double Insulation CCC CE CE CB S-Mark CE China RoHS Level VI RoHS Ukraine VCCI WEEE PSE PSE PSE CB

Model No. GTM96300-2307.5-1.55-R2

Part No./Ordering No. RR9KB3865T00NAIMR6B

Rev B

**POWER SUPPLY INFORMATION**

TYPE: Wall Plug-in+Desktop Combination  
 TECHNOLOGY: Regulated Switchmode AC-DC Power Supply AC Adaptor  
 CASE COLOR: GlobTek Black  
 NAMEPLATE RATED INPUT: 100-240V~, 50-60 Hz, 1A  
 INPUT CONFIG: IEC 60320/C8 w/ Wall Blades Option  
 WATTS: 23.0  
 VOLTS OUT: 5.95  
 CURRENT OUT (Amps): 3.86  
 BLADE/CORD INCLUDED: R-NA-2(R):  
 BLADE/CORD INSTALLED: R-NA-2(R):  
 GROUNDING CONFIGURATION (F1) Class II / Double Insulated  
 EFFICIENCY LEVEL: VI  
 OUTPUT CONFIGURATION 1200 mm, 16/2 Cond, Round Black, T-plug system, Ferrite: None, GlobTek Black, GT Cord # C4257  
 CONNECTOR PIN OUT: Polarity Configuration T00 All plugs are Medical Grade, Locking, Polarized once installed, and single use only. Product demonstration link: <https://en.globtek.com/news/t00-changeable-output-plug-system-for-power-supplies> MOLDED CONNECTORS AVAILABLE  
 LABEL SPECS: Standard GT,L-1186  
 PACK SPEC: Packing for DT (hybrid) model with T00 plug and manual

Notes/Modifications/Customizations (notes in this section supersede the values shown in the standard spec):

DIMENSIONS ARE IN MM UNLESS SPECIFIED OTHERWISE.

GlobTek, Inc.  
www.globtek.com  
186 Veterans Drive,  
Northvale, NJ 07647  
Tel. (201) 784-1000  
Fax (201) 784-0111

Drawing Title: GTM96300-2307.5-1.55-R2, Medical/ITE/Household use Power Supply, Efficiency Level: VI, Case Color/Style: GlobTek Black, Wall Plug-in+Desktop Combination, Regulated Switchmode AC-DC Power Supply AC Adaptor, Input Rating: 100-240V~, 50-60 Hz, IEC 60320/C8 w/ Wall Blades Option , Output Rating: 23W, 5.95V@3.86A, Output Configuration: 1200 mm, 16/2 Cond, Round Black, T-plug system, Ferrite: None, GlobTek Black, GT Cord # C4257, Pin Out: Polarity Configuration T00 All plugs are Medical Grade, Locking, Polarized once installed, and single use only. Product demonstration link: <https://en.globtek.com/news/t00-changeable-output-plug-system-for-power-supplies> MOLDED CONNECTORS AVAILABLE, Blades/Input Cord: R-Series 1-15P North America, Approvals: CB CB ETL ETL ETL 230V CoC Tier 2 EAC cETLus cETLus cETLus FCC CAN ICES-3 cETLus 60601-1 3rd S-Mark Double Insulation CCC CE CE CB S-Mark CE China RoHS Level VI RoHS Ukraine VCCI WEEE PSE PSE PSE CB

Model No. GTM96300-2307.5-1.55-R2

Part No./Ordering No. RR9KB3865T00NAIMR6B

Rev B

## ELECTRICAL SPECIFICATIONS

### A) ELECTRICAL SPECIFICATIONS:

01. Input Voltage: Specified 90-264 Vac, Nameplate rated: 100-240Vac  
90-264 Vac range @ 100% of rated load current  
85-264 Vac range @ 85% of rated load current  
110-370 VDC range @ 100% of rated load current
02. Input Frequency: Specified 47-63 Hz, Nameplate rated 50-60Hz
03. Output Regulation: +/- 5% measured at the output connector
04. Line Voltage Regulation: +/- 0.5% typical measured at full load
05. Green Power On Indicator LED
06. Output Ripple (Vp-p): 1% or 100 mV whichever is greater, measured at 20 MHz bandwidth with 0.1 uf ceramic capacitor in parallel with a low impedance 47 uf electrolytic capacitor connected at the end of the output connector
07. Turn-ON/OFF Overshoot: 5% maximum, 1 mS typical recovery time for 40% to 70% step load
08. Turn-ON Delay: 1 second maximum @ full load, nominal line
09. Hold-Up Time: 8 mS typical @ nominal input voltage and full load
10. Inrush Current: 30A/60A maximum cold start @ 115/230Vac input
11. Efficiency: Compliant with Efficiency Level VI and CoC Tier 2 standards
12. No Load Standby Power: <0.075 W @ 230Vac

### B) PROTECTION

01. Input Protection: Input line fusing and 300Vac MOV
02. Short Circuit/ Overload: Electronically Protected unit will auto recover upon removal of fault  
Output Current Limit: 110% to 160% of rated output current  
(upper end of current limit range is determined by normal output power rating, not derated output power level)
03. Output Over-Voltage: 110% to 130% of nominal output voltage

### C) SAFETY

01. Dielectric Withstand Voltage: 4000Vac or 5656Vdc from input to output, On Class I models, 3000Vac or 4242Vdc from input to earth
02. Earth Leakage Current: Class I models < 300uA, N/A for Class II models
03. Touch Current: Class I models < 20uA, Class II models < 75uA
04. Earth Continuity Test: < 0.1 Ohm between Earth Pin at AC input and PCB termination point (Class I models only)
05. Means of Protection: 2 x MOPP
06. Compliant Standards: See listings at end of this drawing for specifics
07. [Output Isolation Options:](#)
  - a) C8 or C18 Inlet, Class II
  - b) C6 or C14 Inlet, Class II FE, Output Isolated from Earth contact
  - c) C6 or C14 Inlet, Class I, Output negative directly attached to Earth contact

### D) EMC

EN 60601-1-2, 4<sup>th</sup> edition  
Emissions, per EN 55032, EN 61000-6-3, EN 61000-6-4  
Conducted Emissions: Class B, FCC Part 15, Class B  
Radiated Emissions: Class B, FCC Part 15, Class B  
Line Frequency Harmonics EN61000-3-2, Class A  
Voltage Fluctuations/Flicker EN61000-3-3

Immunity, per EN 55024, EN 61000-6-1, EN 61000-6-2  
Static Discharge Immunity EN61000-4-2, 10kV Contact Discharge, 20kV air discharge  
Radiated RF Immunity EN61000-4-3, 10V/m 80-1000MHz, 3V/m 1-2.7GHz, 80% 1KHz AM.  
EFT/Burst Immunity EN61000-4-4, 4kV/100kHz.  
Line Surge Immunity EN61000-4-5, 2kV differential, 4kV common-mode  
Conducted RF Immunity EN61000-4-6, 3Vrms, 80% 1KHz AM  
Power Frequency Magnetic Field Immunity EN61000-4-8, 3A/m  
Voltage Dip Immunity EN61000-4-11, Criteria

### E) OTHER:

01. MTBF: 1,000,000 Hours @ 40°C ambient temperature, Full Load

#### PROPRIETARY INFORMATION

PROPRIETARY OF GLOBTEK, INC. ANY REPRODUCTION, DISCLOSURE OR USE OF THIS DRAWING, IN WHOLE OR IN PART, IS HEREBY PROHIBITED EXCEPT AS SPECIFIED IN

WRITING BY GLOBTEK, INC.

quest /08/20/2018 7:42:07 AM

GlobTek, Inc.  
www.globtek.com  
186 Veterans Drive,  
Northvale, NJ 07647  
Tel. (201) 784-1000  
Fax (201) 784-0111

Drawing Title: GTM96300-2307.5-1.55-R2, Medical/ITE/Household use Power Supply, Efficiency Level: VI, Case Color/Style: GlobTek Black, Wall Plug-in+Desktop Combination, Regulated Switchmode AC-DC Power Supply AC Adaptor, Input Rating: 100-240V~, 50-60 Hz, IEC 60320/C8 w/ Wall Blades Option , Output Rating: 23W, 5.95V@3.86A, Output Configuration: 1200 mm, 16/2 Cond, Round Black, T-plug system, Ferrite: None, GlobTek Black, GT Cord # C4257, Pin Out: Polarity Configuration T00 All plugs are Medical Grade, Locking, Polarized once installed, and single use only. Product demonstration link: <https://en.globtek.com/news/t00-changeable-output-plug-system-for-power-supplies> MOLDED CONNECTORS AVAILABLE, Blades/Input Cord: R-Series 1-15P North America, Approvals: CB CB ETL ETL ETL 230V CoC Tier 2 EAC cETLus cETLus cETLus FCC CAN ICES-3 cETLus 60601-1 3rd S-Mark Double Insulation CCC CE CE CB S-Mark CE China RoHS Level VI RoHS Ukraine VCCI WEEE PSE PSE PSE CB

Model No. GTM96300-2307.5-1.55-R2

Part No./Ordering No. RR9KB3865T00NAIMR6B

Rev B

## 02. Operating Temperature:

- 20°C to 40°C ambient temperature at full load,
- 40°C to 50°C ambient temperature with derating to 80% load

## 03. Operating Humidity: 0% to 95% relative humidity, non-condensing

## 04. Storage Temperature: -30°C to 80°C

## 05. Operating Altitude: 5000 Meters

## 06. Ingress Protection: IP40 standard, IP52 available as special option

## 07. ROHS: Compliant with latest regulations, see approvals section below

## F) ENCLOSURE

### 01. Housing: High impact plastic, 94V0 polycarbonate, non-vented

### 02. Markings: Label or Laser Printed

### 03. AC Input mechanical options: Desktop C6, C8, C14 or C18 IEC Inlet.

Hybrid option (Desktop or Changeable Blade Wall Plug-in) Class I or Class II input

## G) SPECIAL OPTIONS

### 01. Cost reduction, removal of LED

### 02. Custom Cordsets, various cordage types, and connector types

### 03. Custom Markings

### 04. Short term Output Surge Capability

### 05. Reduced Leakage Current versions

### 06. Tightened output voltage tolerance

### 07. Reduced output ripple level

### 08. Reduced output power rating marking

### 09. High Rel PCB laminate with Plated through Holes for IPC610 Class 2 Compliance

### 10. Special Housing Colors and Cordset Colors

### 11. Quasi Constant Current Output, for Lead-Acid Battery Charger Applications

GlobTek, Inc.  
 www.globtek.com  
 186 Veterans Drive,  
 Northvale, NJ 07647  
 Tel. (201) 784-1000  
 Fax (201) 784-0111

Drawing Title: GTM96300-2307.5-1.55-R2, Medical/ITE/Household use Power Supply, Efficiency Level: VI, Case Color/Style: GlobTek Black, Wall Plug-in+Desktop Combination, Regulated Switchmode AC-DC Power Supply AC Adaptor, Input Rating: 100-240V~, 50-60 Hz, IEC 60320/C8 w/ Wall Blades Option , Output Rating: 23W, 5.95V@3.86A, Output Configuration: 1200 mm, 16/2 Cond, Round Black, T-plug system, Ferrite: None, GlobTek Black, GT Cord # C4257, Pin Out: Polarity Configuration T00 All plugs are Medical Grade, Locking, Polarized once installed, and single use only. Product demonstration link: <https://en.globtek.com/news/t00-changeable-output-plug-system-for-power-supplies> MOLDED CONNECTORS AVAILABLE, Blades/Input Cord: R-Series 1-15P North America, Approvals: CB CB ETL ETL ETL 230V CoC Tier 2 EAC cETLus cETLus cETLus FCC CAN ICES-3 cETLus 60601-1 3rd S-Mark Double Insulation CCC CE CE CB S-Mark CE China RoHS Level VI RoHS Ukraine VCCI WEEE PSE PSE PSE CB

Model No. GTM96300-2307.5-1.55-R2

Part No./Ordering No. RR9KB3865T00NAIMR6B

Rev B

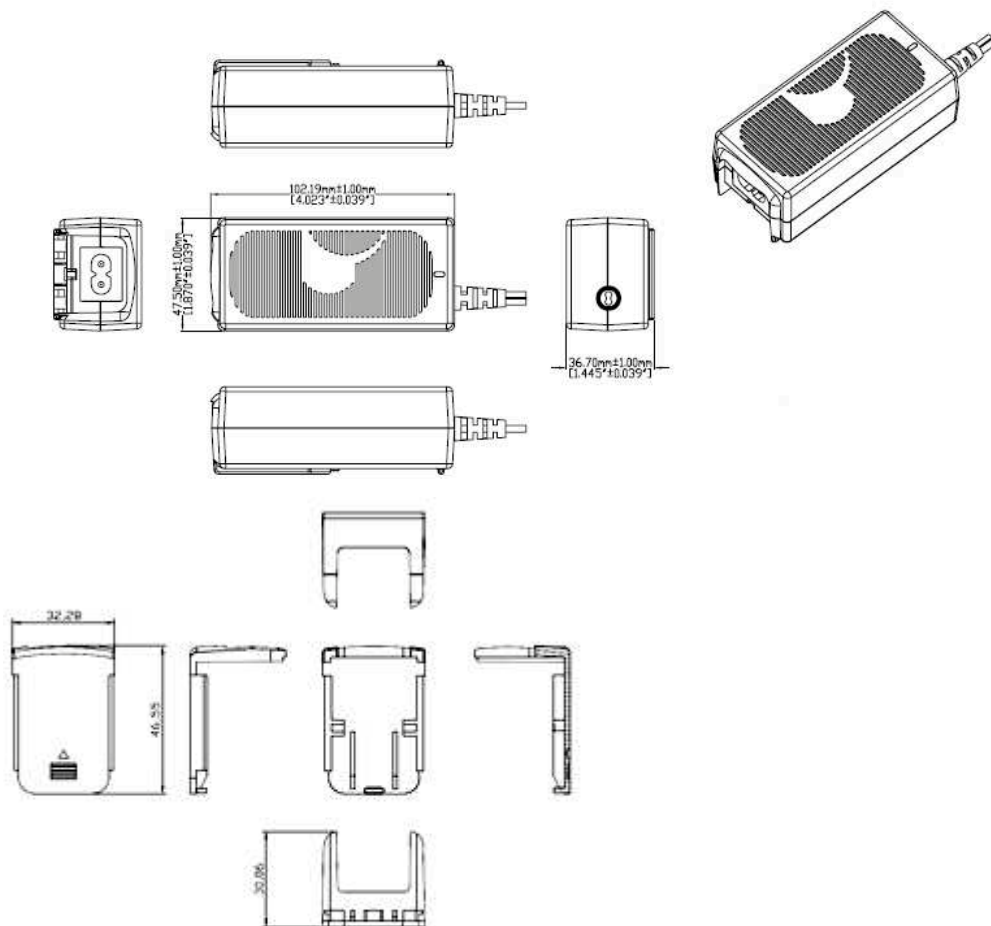

Units shipped without an installed input plug have a "desktop insert" installed.

DERATING CURVE

GlobTek, Inc.  
 www.globtek.com  
 186 Veterans Drive,  
 Northvale, NJ 07647  
 Tel. (201) 784-1000  
 Fax (201) 784-0111

Drawing Title: GTM96300-2307.5-1.55-R2, Medical/ITE/Household use Power Supply, Efficiency Level: VI, Case Color/Style: GlobTek Black, Wall Plug-in+Desktop Combination, Regulated Switchmode AC-DC Power Supply AC Adaptor, Input Rating: 100-240V~, 50-60 Hz, IEC 60320/C8 w/ Wall Blades Option , Output Rating: 23W, 5.95V@3.86A, Output Configuration: 1200 mm, 16/2 Cond, Round Black, T-plug system, Ferrite: None, GlobTek Black, GT Cord # C4257, Pin Out: Polarity Configuration T00 All plugs are Medical Grade, Locking, Polarized once installed, and single use only. Product demonstration link: <https://en.globtek.com/news/t00-changeable-output-plug-system-for-power-supplies> MOLDED CONNECTORS AVAILABLE, Blades/Input Cord: R-Series 1-15P North America, Approvals: CB CB ETL ETL ETL 230V CoC Tier 2 EAC cETLus cETLus cETLus FCC CAN ICES-3 cETLus 60601-1 3rd S-Mark Double Insulation CCC CE CE CB S-Mark CE China RoHS Level VI RoHS Ukraine VCCI WEEE PSE PSE PSE CB

Model No. GTM96300-2307.5-1.55-R2

Part No./Ordering No. RR9KB3865T00NAIMR6B

Rev B

**TYPICAL EXTERNAL POWER SUPPLY DERATING CURVE**

(FOR EFFICIENCY LEVEL V AND EFFICIENCY LEVEL VI PRODUCTS)

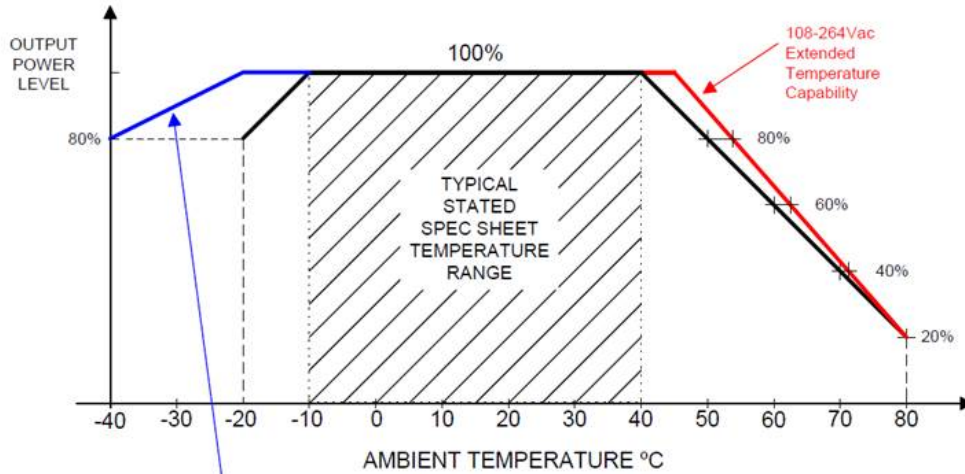

Blue Line represents special/optional Low Temperature, High Performance Construction

108-264 Vac  
 Extended  
 Temperature  
 Capability

TYPICAL  
 STATED  
 SPEC SHEET  
 TEMPERATURE  
 RANGE

GlobTek, Inc.  
 www.globtek.com  
 186 Veterans Drive,  
 Northvale, NJ 07647  
 Tel. (201) 784-1000  
 Fax (201) 784-0111

Drawing Title: GTM96300-2307.5-1.55-R2, Medical/ITE/Household use Power Supply, Efficiency Level: VI, Case Color/Style: GlobTek Black, Wall Plug-in+Desktop Combination, Regulated Switchmode AC-DC Power Supply AC Adaptor, Input Rating: 100-240V~, 50-60 Hz, IEC 60320/C8 w/ Wall Blades Option , Output Rating: 23W, 5.95V@3.86A, Output Configuration: 1200 mm, 16/2 Cond, Round Black, T-plug system, Ferrite: None, GlobTek Black, GT Cord # C4257, Pin Out: Polarity Configuration T00 All plugs are Medical Grade, Locking, Polarized once installed, and single use only. Product demonstration link: <https://en.globtek.com/news/t00-changeable-output-plug-system-for-power-supplies> MOLDED CONNECTORS AVAILABLE, Blades/Input Cord: R-Series 1-15P North America, Approvals: CB CB ETL ETL ETL 230V CoC Tier 2 EAC cETLus cETLus cETLus FCC CAN ICES-3 cETLus 60601-1 3rd S-Mark Double Insulation CCC CE CE CB S-Mark CE China RoHS Level VI RoHS Ukraine VCCI WEEE PSE PSE PSE CB

Model No. GTM96300-2307.5-1.55-R2

Part No./Ordering No. RR9KB3865T00NAIMR6B

Rev B

## INPUT CONFIGURATION

Grounding Configuration:

Blades/Cord Included: R-NA-2(R):

Blades/Cord Installed: R-NA-2(R):

IEC 60320/C8 AC Inlet connector

[Blade Insertion Instructions](#)

[R-Blade Style Instruction Video](#)

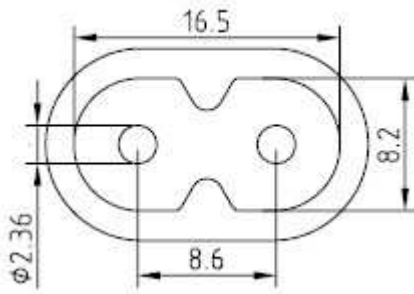

Mates with IEC 60320/C7 Plug

This series of Interchangeable Blade products may be used with Proprietary Interchangeable Blades as described below or with standard international power cords.

Optional INPUT BLADES: R-Socket: below are available blades configurations which are "not included" (unless stated above); may be purchased separately, packaged with power supply, or as a separate "R-KIT" if specified

1. Class II model NEMA 1-15P AC power plug with 2 prongs, R-NA-2(R)
2. Australian AS 3112 configuration: SAA 2 pins Class II, R-SAA-2(R)
3. UK BS 1363 configuration: UK 2 pins (dummy Ground) Class II, R-UK-2(R)
4. European CEE 7/16 configuration: Europlug 2 PINS, Class II, R-EU-2(R)
5. China GB 2099 configuration: 2 blades, Class II; CN P/N:R-CN-2(R)
6. Desktop Insert

Kits

05. R-KIT: 1,2,3,4 above

06. R-KIT-INTL: 2,3,4 above

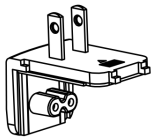

### UL 2P

P/N: R-NA-2(R)  
 NORTH AMERICA  
 JAPAN

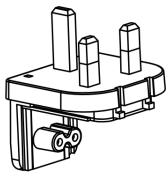

### UK 2P

P/N: R-UK-2(R)  
 UNITED KINGDOM  
 HONG KONG  
 SINGAPORE

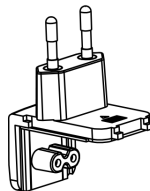

### EU 2P

P/N: R-EU-2(R)  
 EUROPE  
 SOUTH AMERICA

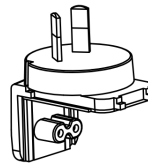

### AUS 2P

P/N: R-SAA-2(R)  
 AUSTRALIA



GlobTek, Inc.  
 www.globtek.com  
 186 Veterans Drive,  
 Northvale, NJ 07647  
 Tel. (201) 784-1000  
 Fax (201) 784-0111

Drawing Title: GTM96300-2307.5-1.55-R2, Medical/ITE/Household use Power Supply, Efficiency Level: VI, Case Color/Style: GlobTek Black, Wall Plug-in+Desktop Combination, Regulated Switchmode AC-DC Power Supply AC Adaptor, Input Rating: 100-240V~, 50-60 Hz, IEC 60320/C8 w/ Wall Blades Option , Output Rating: 23W, 5.95V@3.86A, Output Configuration: 1200 mm, 16/2 Cond, Round Black, T-plug system, Ferrite: None, GlobTek Black, GT Cord # C4257, Pin Out: Polarity Configuration T00 All plugs are Medical Grade, Locking, Polarized once installed, and single use only. Product demonstration link: <https://en.globtek.com/news/t00-changeable-output-plug-system-for-power-supplies> MOLDED CONNECTORS AVAILABLE, Blades/Input Cord: R-Series 1-15P North America, Approvals: CB CB ETL ETL ETL 230V CoC Tier 2 EAC cETLus cETLus cETLus FCC CAN ICES-3 cETLus 60601-1 3rd S-Mark Double Insulation CCC CE CE CB S-Mark CE China RoHS Level VI RoHS Ukraine VCCI WEEE PSE PSE PSE CB

Model No. GTM96300-2307.5-1.55-R2

Part No./Ordering No. RR9KB3865T00NAIMR6B

Rev B

**Standard Cordsets**

Below are standard cordsets which are "not included" (unless stated above); these may be purchased separately or packaged with the power supply. Contact your Sales Engineer if the style required is not shown below. Many more available in different lengths, colors or cable material.

[Standard International IEC 320/C7 Cordsets](#)

<a href="#">4511116F703A(R)</a>	N. American, Type A	NEMA 1-15P	IEC 320/C7	1830	6
<a href="#">5014112M703A(R)</a>	Australian	AS 3112	IEC 320/C7	2000	7
2094112M703(R)	Argentina	IRAM 2063	IEC 320/C7	2000	7
<a href="#">4533501M8703(R)</a>	China	GB 2099.1	IEC 320/C7	1830	6
<a href="#">2074112M703A(R)</a>	European, Type C	CEE 7/16	IEC 320/C7	2000	7
<a href="#">451J3401M8703(R)</a>	Japan	JIS 8303	IEC 320/C7	1830	6
<a href="#">6104112M703A(R)</a>	UK, Type G	BS1363	IEC 320/C7	2000	7
2044112M703®	Korea	KS C8305	IEC 320/C7	2000	7
<a href="#">4033401M8703A(R)</a>	Taiwan	CNS690	IEC 320/C7	1830	6
<a href="#">207B4111M8703(R)</a>	Brazil	NBR14136	IEC 320/C7	1800	6

GlobTek, Inc.  
 www.globtek.com  
 186 Veterans Drive,  
 Northvale, NJ 07647  
 Tel. (201) 784-1000  
 Fax (201) 784-0111

Drawing Title: GTM96300-2307.5-1.55-R2, Medical/ITE/Household use Power Supply, Efficiency Level: VI, Case Color/Style: GlobTek Black, Wall Plug-in+Desktop Combination, Regulated Switchmode AC-DC Power Supply AC Adaptor, Input Rating: 100-240V~, 50-60 Hz, IEC 60320/C8 w/ Wall Blades Option , Output Rating: 23W, 5.95V@3.86A, Output Configuration: 1200 mm, 16/2 Cond, Round Black, T-plug system, Ferrite: None, GlobTek Black, GT Cord # C4257, Pin Out: Polarity Configuration T00 All plugs are Medical Grade, Locking, Polarized once installed, and single use only. Product demonstration link: <https://en.globtek.com/news/t00-changeable-output-plug-system-for-power-supplies> MOLDED CONNECTORS AVAILABLE, Blades/Input Cord: R-Series 1-15P North America, Approvals: CB CB ETL ETL ETL 230V CoC Tier 2 EAC cETLus cETLus cETLus FCC CAN ICES-3 cETLus 60601-1 3rd S-Mark Double Insulation CCC CE CE CB S-Mark CE China RoHS Level VI RoHS Ukraine VCCI WEEE PSE PSE PSE CB

Model No. GTM96300-2307.5-1.55-R2

Part No./Ordering No. RR9KB3865T00NAIMR6B

Rev B

**OUTPUT CORD AND CONNECTOR: T00/C4257**

ACTUAL CONNECTORS, OVERMOLDS, FERRITES MAY VARY SLIGHTLY FROM THE PICTURE BELOW

CABLE TYPE Round Black

CABLE LENGTH (mm) 1200

CABLE TOLERANCE (mm) ± 50

WIRE GAUGE (AWG) 16

CONDUCTORS 2

HANK DIMENSION (mm) 80 ± 10

CABLE / CONNECTOR GlobTek Black

OVERMOLD COLOR

FERRITE TYPE / DIMENSION None

FERRITE # OF TURNS ([Definition](#)) N/A

FERRITE DIMENSION FROM STRAIN RELIEF N/A

FERRITE DIMENSION FROM PLUG N/A

PLUG TYPE T-plug system

OVER MOLD ORIENTATION Straight

CONNECTOR PIN OUT: Polarity Configuration T00 All plugs are Medical Grade, Locking, Polarized once installed, and single use only. Product demonstration link: <https://en.globtek.com/news/t00-changeable-output-plug-system-for-power-supplies> MOLDED CONNECTORS AVAILABLE

**ADDITIONAL REQUIREMENTS**

This novel system allows for rapid shipment of prototype samples or small quantities of common output voltage and current which can fulfill the needs of most common barrel plug specs. The table below explains the standard and non standard options available as part of this system. This system also allows for both Center Positive and Center Negative polarity.

The T00 plug and adapters are Medical Grade, single use only, Polarized after installation, and not removable without use of special tool.

Any of the below options, and more, are available as molded plugs from stock or special order. Please contact GlobTek for more information

GlobTek, Inc.  
 www.globtek.com  
 186 Veterans Drive,  
 Northvale, NJ 07647  
 Tel. (201) 784-1000  
 Fax (201) 784-0111

Drawing Title: GTM96300-2307.5-1.55-R2, Medical/ITE/Household use Power Supply, Efficiency Level: VI, Case Color/Style: GlobTek Black, Wall Plug-in+Desktop Combination, Regulated Switchmode AC-DC Power Supply AC Adaptor, Input Rating: 100-240V~, 50-60 Hz, IEC 60320/C8 w/ Wall Blades Option , Output Rating: 23W, 5.95V@3.86A, Output Configuration: 1200 mm, 16/2 Cond, Round Black, T-plug system, Ferrite: None, GlobTek Black, GT Cord # C4257, Pin Out: Polarity Configuration T00 All plugs are Medical Grade, Locking, Polarized once installed, and single use only. Product demonstration link: <https://en.globtek.com/news/t00-changeable-output-plug-system-for-power-supplies> MOLDED CONNECTORS AVAILABLE, Blades/Input Cord: R-Series 1-15P North America, Approvals: CB CB ETL ETL ETL 230V CoC Tier 2 EAC cETLus cETLus cETLus FCC CAN ICES-3 cETLus 60601-1 3rd S-Mark Double Insulation CCC CE CE CB S-Mark CE China RoHS Level VI RoHS Ukraine VCCI WEEE PSE PSE PSE CB

Model No. GTM96300-2307.5-1.55-R2

Part No./Ordering No. RR9KB3865T00NAIMR6B

Rev B

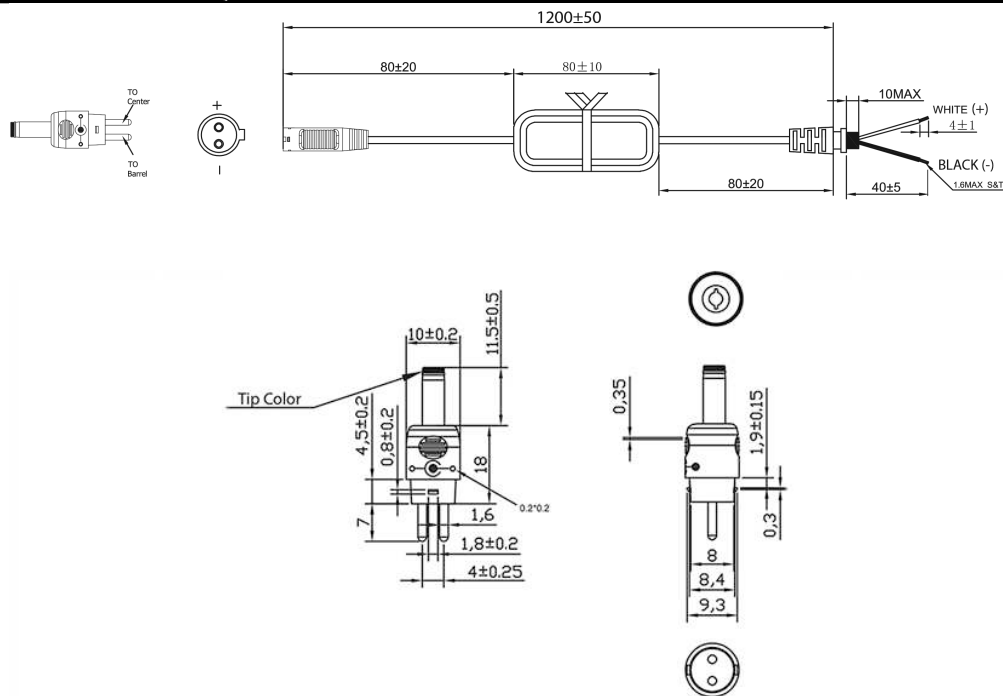

Part #	CROSS REFERENCE	OUTER DIAMETER	INNER DIAMETER	PINLENGTH	FORM FACTOR	MALE/FEMALE	INCLUDED IN T00 KIT	TIP COLOR
T-K-11-S(R)	Philmore® 204/2049		3.5	1.3-	11STRAIGHT	Female	x	Blue
T-EJ2-95-S(R)	Philmore® 240 plug		4	1.7-	9.5STRAIGHT	Female	Order Separately	Brown
T-EJ3-95-S(R)	Philmore® 275 plug		4.75	1.7-	9.5STRAIGHT	Female	Order Separately	Red
T-C-95-S(R)	Switchcraft® 722A		5.5	2.1-	9.5STRAIGHT	Female	Order Separately	Yellow
T-C-12-S(R)	Switchcraft® 722A		5.5	2.1-	12STRAIGHT	Female	x	Yellow
T-L-95-S(R)	Switchcraft® 712A		5.5	2.5-	9.5STRAIGHT	Female	Order Separately	Black
T-L-12-S(R)	Switchcraft® 712A		5.5	2.5-	12STRAIGHT	Female	x	Black
T-EJ4-95-S(R)	Philmore® 255 plug		5.5	3.3 1	9.5STRAIGHT	Female	Order Separately	Orange
T-EJ1-95-S(R)	Philmore 235 plug		2.35	0.7	9.5STRAIGHT	Female	Order Separately	Yellow
T-EJ5-115-S(R)	Philmore 265 plug		6.5	6 1	11.5STRAIGHT	Female	Order Separately	Black

STRAIGHT Female Barrels are available in length of 9mm-14mm

ADDITIONAL OUTPUT PLUG OPTIONS ARE AVAILABLE AT <http://www.globtek.com/connectors/>  
 STANDARD PLUGS AND CONNECTORS CAN BE SEEN ONLINE AT <http://www.globtek.com/connectors/>

PROPRIETARY INFORMATION

PROPRIETARY OF GLOBTEK, INC. ANY REPRODUCTION, DISCLOSURE OR USE OF THIS DRAWING, IN WHOLE OR IN PART, IS HEREBY PROHIBITED EXCEPT AS SPECIFIED IN WRITING BY GLOBTEK, INC. Page 10 of 15  
 quest /08/20/2018 7:42:07 AM

GlobTek, Inc.  
 www.globtek.com  
 186 Veterans Drive,  
 Northvale, NJ 07647  
 Tel. (201) 784-1000  
 Fax (201) 784-0111

Drawing Title: GTM96300-2307.5-1.55-R2, Medical/ITE/Household use Power Supply, Efficiency Level: VI, Case Color/Style: GlobTek Black, Wall Plug-in+Desktop Combination, Regulated Switchmode AC-DC Power Supply AC Adaptor, Input Rating: 100-240V~, 50-60 Hz, IEC 60320/C8 w/ Wall Blades Option , Output Rating: 23W, 5.95V@3.86A, Output Configuration: 1200 mm, 16/2 Cond, Round Black, T-plug system, Ferrite: None, GlobTek Black, GT Cord # C4257, Pin Out: Polarity Configuration T00 All plugs are Medical Grade, Locking, Polarized once installed, and single use only. Product demonstration link: <https://en.globtek.com/news/t00-changeable-output-plug-system-for-power-supplies> MOLDED CONNECTORS AVAILABLE, Blades/Input Cord: R-Series 1-15P North America, Approvals: CB CB ETL ETL ETL 230V CoC Tier 2 EAC cETLus cETLus cETLus FCC CAN ICES-3 cETLus 60601-1 3rd S-Mark Double Insulation CCC CE CE CB S-Mark CE China RoHS Level VI RoHS Ukraine VCCI WEEE PSE PSE PSE CB

Model No. GTM96300-2307.5-1.55-R2

Part No./Ordering No. RR9KB3865T00NAIMR6B

Rev B

**LABEL:L-1186**

LABEL P/N: Standard GT  
 MATERIAL: Flat Thermal Transfer, Imprintable, Polyester Label and/or Pad Printed and/or Molded, and/or Laser Engraved in the case  
 BACKGROUND COLOR: Black if housing is Black, White or Silver if housing is White or Gray.  
 TEXT COLOR: White or Silver if label is Black Background for Black housing. Black if label is White or Silver background and Housing is White or Gray  
 LABEL WIDTH (mm): 37.5  
 LABEL HEIGHT (mm): 33.5

Below is the minimum information which will appear on the label. NOTE: in the logo area additional/actual positioning of symbols and text is subjected to change as per agency updates/requirements or additional model approvals become available. Regulatory certifications/label markings may be in logo area on the label or molded into the case housing outside the label area. Information will be shown via label and/or pad printed and/or molded and/or laser engraved in the case. \* Date code markings at GlobTek option.

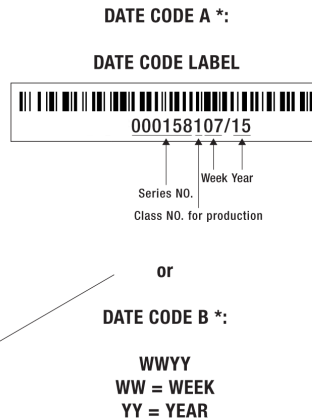
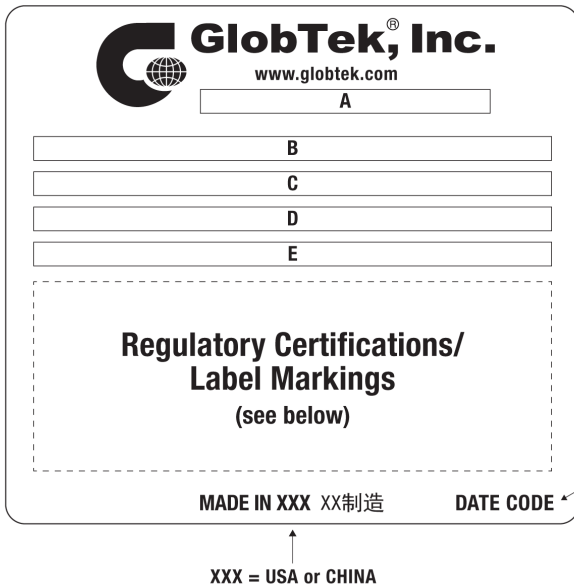

A=Medical/ITE/Household use Power Supply  
 B=P/N: (料号) RR9KB3865T00NAIMR6B  
 C=Model (型号) GTM96300-2307.5-1.55-R2  
 D=Input (输入) 100-240V~, 50-60 Hz, 1A  
 E=Output (输出) 5.95 V  $\equiv$  3.86 A , 23.0W

- AGENCY ONLINE DOCUMENTS <http://www.globtek.info/certs/GTM96300-TZ/>
- CE EC-Declaration for Medical [http://www.globtek.com/pdf/ec\\_declaration/a00a000000MmVxmEAF](http://www.globtek.com/pdf/ec_declaration/a00a000000MmVxmEAF)
- CE EC-Declaration for Industrial/Commercial/ITE [http://www.globtek.com/pdf/ec\\_declaration/a00a000000MmVxmEAF](http://www.globtek.com/pdf/ec_declaration/a00a000000MmVxmEAF)
- RoHS/RoHS2 Declaration [http://www.globtek.com/pdf/rohs\\_cert/01ta0000007dRHQAA2](http://www.globtek.com/pdf/rohs_cert/01ta0000007dRHQAA2)
- REACH Declaration [http://www.globtek.com/pdf/iso\\_certificates/REACH.pdf](http://www.globtek.com/pdf/iso_certificates/REACH.pdf)

GlobTek, Inc.  
www.globtek.com  
186 Veterans Drive,  
Northvale, NJ 07647  
Tel. (201) 784-1000  
Fax (201) 784-0111

Drawing Title: GTM96300-2307.5-1.55-R2, Medical/ITE/Household use Power Supply, Efficiency Level: VI, Case Color/Style: GlobTek Black, Wall Plug-in+Desktop Combination, Regulated Switchmode AC-DC Power Supply AC Adaptor, Input Rating: 100-240V~, 50-60 Hz, IEC 60320/C8 w/ Wall Blades Option , Output Rating: 23W, 5.95V@3.86A, Output Configuration: 1200 mm, 16/2 Cond, Round Black, T-plug system, Ferrite: None, GlobTek Black, GT Cord # C4257, Pin Out: Polarity Configuration T00 All plugs are Medical Grade, Locking, Polarized once installed, and single use only. Product demonstration link: <https://en.globtek.com/news/t00-changeable-output-plug-system-for-power-supplies> MOLDED CONNECTORS AVAILABLE, Blades/Input Cord: R-Series 1-15P North America, Approvals: CB CB ETL ETL ETL 230V CoC Tier 2 EAC cETLus cETLus cETLus FCC CAN ICES-3 cETLus 60601-1 3rd S-Mark Double Insulation CCC CE CE CB S-Mark CE China RoHS Level VI RoHS Ukraine VCCI WEEE PSE PSE PSE CB

Model No. GTM96300-2307.5-1.55-R2

Part No./Ordering No. RR9KB3865T00NAIMR6B

Rev B

Conflict Minerals Declaration

<http://www.globtek.com/pdf/conflict-minerals.pdf>

IPXY rating is based on 3rd party testing and customers should check suitability and test system level IPXY rating before ordering.

## Regulatory Certifications/Label Markings

LATEST PRODUCT/MODEL CERTIFICATIONS: <http://en.globtek.com/datasheet/id/a0Oa000000MmVxm>

AGENCY ONLINE DOCUMENTS: <http://www.globtek.info/certs/GTM96300-TZ/>

Polarity Configuration T00 All plugs are Medical Grade, Locking, Polarized once installed, and single use only. Product demonstration link: <https://en.globtek.com/news/t00-changeable-output-plug-system-for-power-supplies> MOLDED CONNECTORS AVAILABLE

GlobTek, Inc.  
 www.globtek.com  
 186 Veterans Drive,  
 Northvale, NJ 07647  
 Tel. (201) 784-1000  
 Fax (201) 784-0111

Drawing Title: GTM96300-2307.5-1.55-R2, Medical/ITE/Household use Power Supply, Efficiency Level: VI, Case Color/Style: GlobTek Black, Wall Plug-in+Desktop Combination, Regulated Switchmode AC-DC Power Supply AC Adaptor, Input Rating: 100-240V~, 50-60 Hz, IEC 60320/C8 w/ Wall Blades Option , Output Rating: 23W, 5.95V@3.86A, Output Configuration: 1200 mm, 16/2 Cond, Round Black, T-plug system, Ferrite: None, GlobTek Black, GT Cord # C4257, Pin Out: Polarity Configuration T00 All plugs are Medical Grade, Locking, Polarized once installed, and single use only. Product demonstration link: <https://en.globtek.com/news/t00-changeable-output-plug-system-for-power-supplies> MOLDED CONNECTORS AVAILABLE, Blades/Input Cord: R-Series 1-15P North America, Approvals: CB CB ETL ETL ETL 230V CoC Tier 2 EAC cETLus cETLus cETLus FCC CAN ICES-3 cETLus 60601-1 3rd S-Mark Double Insulation CCC CE CE CB S-Mark CE China RoHS Level VI RoHS Ukraine VCCI WEEE PSE PSE PSE CB

Model No. GTM96300-2307.5-1.55-R2

Part No./Ordering No. RR9KB3865T00NAIMR6B

Rev B

## PACKAGING

Packing Spec P/N:	Packing for DT (hybrid) model with T00 plug and manual
Box Qty:	48
Gift Box Size (mm):	Egg Crate
Gift Box Color:	White
Master Carton Size (mm):	442*330*275
Master GW (Kg):	15.2 kg
BLADES INCLUDED:	R-NA-2(R):
BLADE/CORD INSTALLED:	R-NA-2(R):

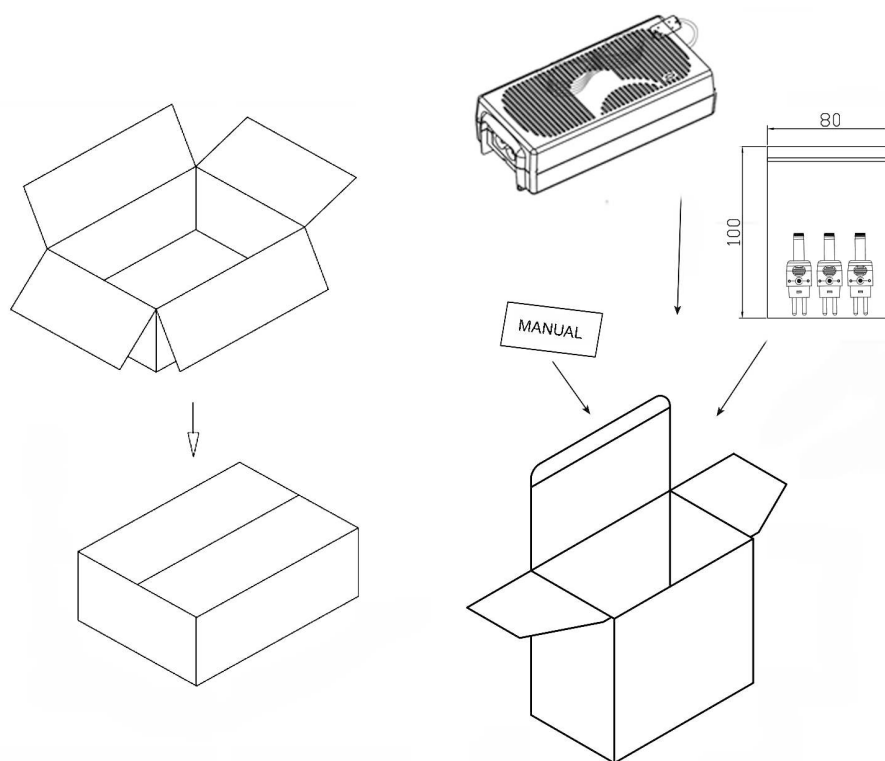

Manual for T00-plug:

GlobTek, Inc.  
 www.globtek.com  
 186 Veterans Drive,  
 Northvale, NJ 07647  
 Tel. (201) 784-1000  
 Fax (201) 784-0111

Drawing Title: GTM96300-2307.5-1.55-R2, Medical/ITE/Household use Power Supply, Efficiency Level: VI, Case Color/Style: GlobTek Black, Wall Plug-in+Desktop Combination, Regulated Switchmode AC-DC Power Supply AC Adaptor, Input Rating: 100-240V~, 50-60 Hz, IEC 60320/C8 w/ Wall Blades Option , Output Rating: 23W, 5.95V@3.86A, Output Configuration: 1200 mm, 16/2 Cond, Round Black, T-plug system, Ferrite: None, GlobTek Black, GT Cord # C4257, Pin Out: Polarity Configuration T00 All plugs are Medical Grade, Locking, Polarized once installed, and single use only. Product demonstration link: <https://en.globtek.com/news/t00-changeable-output-plug-system-for-power-supplies> MOLDED CONNECTORS AVAILABLE, Blades/Input Cord: R-Series 1-15P North America, Approvals: CB CB ETL ETL ETL 230V CoC Tier 2 EAC cETLus cETLus cETLus FCC CAN ICES-3 cETLus 60601-1 3rd S-Mark Double Insulation CCC CE CE CB S-Mark CE China RoHS Level VI RoHS Ukraine VCCI WEEE PSE PSE PSE CB

Model No. GTM96300-2307.5-1.55-R2

Part No./Ordering No. RR9KB3865T00NAIMR6B

Rev B



**T-Tip Instructions**

- Color of tip indicates dimensions of barrel
- Polarity is dependent on how tip is inserted in to T-base

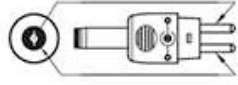

This Pin Connects to Center



This Pin Connects to Barrel

PART NO	DIAMETER		LENGTH	TIP COLOR
	OUTER	INNER		
T-C-12-S(R)	5.5	2.1	12	YELLOW
T-L-12-S(R)	5.5	2.5	12	BLACK
T-K-11-S(R)	3.5	1.3	11	BLUE
T-EJ2-95-S(R)	4.0	1.7	9.5	BROWN
T-EJ3-95-S(R)	4.75	1.7	9.5	RED
T-EJ4-95-S(R)	5.5	3.3	9.5	ORANGE
T-EJ1-95-S(R)	2.35	0.7	9.5	YELLOW
T-EJ5-115-S(R)	6.5	6.0	11.5	BLACK

On the back blank side add:

**Molded options available upon request**

GlobTek, Inc.  
www.globtek.com  
186 Veterans Drive,  
Northvale, NJ 07647  
Tel. (201) 784-1000  
Fax (201) 784-0111

Drawing Title: GTM96300-2307.5-1.55-R2, Medical/ITE/Household use Power Supply, Efficiency Level: VI, Case Color/Style: GlobTek Black, Wall Plug-in+Desktop Combination, Regulated Switchmode AC-DC Power Supply AC Adaptor, Input Rating: 100-240V~, 50-60 Hz, IEC 60320/C8 w/ Wall Blades Option , Output Rating: 23W, 5.95V@3.86A, Output Configuration: 1200 mm, 16/2 Cond, Round Black, T-plug system, Ferrite: None, GlobTek Black, GT Cord # C4257, Pin Out: Polarity Configuration T00 All plugs are Medical Grade, Locking, Polarized once installed, and single use only. Product demonstration link: <https://en.globtek.com/news/t00-changeable-output-plug-system-for-power-supplies> MOLDED CONNECTORS AVAILABLE, Blades/Input Cord: R-Series 1-15P North America, Approvals: CB CB ETL ETL ETL 230V CoC Tier 2 EAC cETLus cETLus cETLus FCC CAN ICES-3 cETLus 60601-1 3rd S-Mark Double Insulation CCC CE CE CB S-Mark CE China RoHS Level VI RoHS Ukraine VCCI WEEE PSE PSE PSE CB

Model No. GTM96300-2307.5-1.55-R2

Part No./Ordering No. RR9KB3865T00NAIMR6B

Rev B

## INSTRUCTION SHEET

N/A