



Chipsmall Limited consists of a professional team with an average of over 10 year of expertise in the distribution of electronic components. Based in Hongkong, we have already established firm and mutual-benefit business relationships with customers from,Europe,America and south Asia,supplying obsolete and hard-to-find components to meet their specific needs.

With the principle of “Quality Parts,Customers Priority,Honest Operation,and Considerate Service”,our business mainly focus on the distribution of electronic components. Line cards we deal with include Microchip,ALPS,ROHM,Xilinx,Pulse,ON,Everlight and Freescale. Main products comprise IC,Modules,Potentiometer,IC Socket,Relay,Connector.Our parts cover such applications as commercial,industrial, and automotives areas.

We are looking forward to setting up business relationship with you and hope to provide you with the best service and solution. Let us make a better world for our industry!



Contact us

Tel: +86-755-8981 8866 Fax: +86-755-8427 6832

Email & Skype: info@chipsmall.com Web: www.chipsmall.com

Address: A1208, Overseas Decoration Building, #122 Zhenhua RD., Futian, Shenzhen, China



GlobTek, Inc.
www.globtek.com
186 Veterans Drive,
Northvale, NJ 07647
Tel. (201) 784-1000
Fax (201) 784-0111

Drawing Title: GTM96300-3624-R3A, Medical/ITE/Household use Power Supply, Efficiency Level: VI, Case Color/Style: GlobTek Black, Wall Plug-in+Desktop Combination, Regulated Switchmode AC-DC Power Supply AC Adaptor, Input Rating: 100-240V~, 50-60 Hz, IEC 60320/C6 w/ Wall Blades Option , Output Rating: 36W, 24V@1.5A, Output Configuration: 1530 mm, 18/1C + Shield Cond, UL 1185, Female Barrel 5.5 * 2.5 * 11mm with internal Spring Clip and Locking Notch or Equal, Ferrite: None, GlobTek Black, GT Cord # C0170, Pin Out: Center Positive (+V), Blades/Input Cord: R-Series 5-15P North America, Approvals: CB CB ETL ETL ETL 230V CoC Tier 2 EAC CAN ICES-3 FCC cETLus 60601-1 3rd CB IP40 LPS Class I cETLus 60950 S-Mark PSE PSE PSE CE China RoHS Level VI RoHS Ukraine VCCI WEEE CB cETLus CCC S-Mark

Model No. GTM96300-3624-R3A

Part No./Ordering No. RR9LI1500LCPIMNAR6B

Rev B

REVISION HISTORY

REV	DESCRIPTION	SUB	DATE	APPROVED
B	Add UL1310 approval and "Class 2 Power Supply" to label.	bsiep	08/03/2017	QA
A	Initial Release	jwarr	05/02/2017	QA

In Addition to GlobTek Inc.'s renewed ISO9001:2008 - Quality Management System Certification, GlobTek Inc. is now certified to:

ISO13485:2003 - Medical Devices Quality Management System Certification
ISO14001:2004 - Environmental Management System Certification

ISO Certificates are available online at <http://www.globtek.com/iso-certificates/>

Customer Approval of Specification:

Please approve, sign and send back to GlobTek so we can complete order processing.

A delay in receipt of this form will delay delivery schedule.

Company Name:

Customer P/N:

Quote Number:

Date:

Authorized Representative Name:

Authorized Representative Signature:

The acceptance of this specification and use of the product described in this document indicates the acceptance and binding of the customer to Globtek terms and conditions, which supersede all other agreements, terms, and conditions (<http://en.globtek.com/terms-and-conditions/>).

Footnote:

GlobTek Inc. will not be liable for the safety and performance of these power supplies if unauthorized access and repair occurs. End user should consult applicable UL, CSA or EN standards for proper installation instruction.

Limitation of Use:

GlobTek product are not authorized for use as mission critical components in life support hazardous environment, nuclear or aircraft applications without prior written approval from the CEO of GlobTek Inc.

Contents of this document are subject to change without prior notice.

GTM96300-3624-R3A, 36W, 24V@1.5A, Wall Plug-in+Desktop Combination, Regulated Switchmode AC-DC Power Supply AC Adaptor

PROPRIETARY INFORMATION

PROPRIETARY OF GLOBTEK, INC. ANY REPRODUCTION, DISCLOSURE OR USE OF THIS DRAWING, IN WHOLE OR IN PART, IS HEREBY PROHIBITED EXCEPT AS SPECIFIED IN WRITING BY GLOBTEK, INC.

Page 1 of 12

quest /08/20/2018 1:12:23 PM

GlobTek, Inc.
www.globtek.com
186 Veterans Drive,
Northvale, NJ 07647
Tel. (201) 784-1000
Fax (201) 784-0111

Drawing Title: GTM96300-3624-R3A, Medical/ITE/Household use Power Supply, Efficiency Level: VI, Case Color/Style: GlobTek Black, Wall Plug-in+Desktop Combination, Regulated Switchmode AC-DC Power Supply AC Adaptor, Input Rating: 100-240V~, 50-60 Hz, IEC 60320/C6 w/ Wall Blades Option , Output Rating: 36W, 24V@1.5A, Output Configuration: 1530 mm, 18/1C + Shield Cond, UL 1185, Female Barrel 5.5 * 2.5 * 11mm with internal Spring Clip and Locking Notch or Equal, Ferrite: None, GlobTek Black, GT Cord # C0170, Pin Out: Center Positive (+V), Blades/Input Cord: R-Series 5-15P North America, Approvals: CB CB ETL ETL ETL 230V CoC Tier 2 EAC CAN ICES-3 FCC cETLus 60601-1 3rd CB IP40 LPS Class I cETLus 60950 S-Mark PSE PSE PSE CE China RoHS Level VI RoHS Ukraine VCCI WEEE CB cETLus CCC S-Mark

Model No. GTM96300-3624-R3A

Part No./Ordering No. RR9LI1500LCPIMNAR6B

Rev B

POWER SUPPLY INFORMATION

TYPE: Wall Plug-in+Desktop Combination
TECHNOLOGY: Regulated Switchmode AC-DC Power Supply AC Adaptor
CASE COLOR: GlobTek Black
NAMEPLATE RATED INPUT: 100-240V~, 50-60 Hz, 1.0A
INPUT CONFIG: IEC 60320/C6 w/ Wall Blades Option
WATTS: 36.0
VOLTS OUT: 24
CURRENT OUT (Amps): 1.5
BLADE/CORD INCLUDED: R-NA-3(R):
BLADE/CORD INSTALLED: R-NA-3(R):
GROUNDING CONFIGURATION: CONFIGURE GROUNDING CONFIGURATION
EFFICIENCY LEVEL: VI
OUTPUT CONFIGURATION: 1530 mm, 18/1C + Shield Cond, UL 1185, Female Barrel 5.5 * 2.5 * 11mm with internal Spring Clip and Locking Notch or Equal, Ferrite: None, GlobTek Black, GT Cord # C0170
CONNECTOR PIN OUT: Center Positive (+V)
LABEL SPECS: Standard GT,L-1186
PACK SPEC: Standard WPI, Individually Box

Notes/Modifications/Customizations (notes in this section supersede the values shown in the standard spec):

DIMENSIONS ARE IN MM UNLESS SPECIFIED OTHERWISE.

GloTek, Inc. www.globtek.com 186 Veterans Drive, Northvale, NJ 07647 Tel. (201) 784-1000 Fax (201) 784-0111	Drawing Title: GTM96300-3624-R3A, Medical/ITE/Household use Power Supply, Efficiency Level: VI, Case Color/Style: GlobTek Black, Wall Plug-in+Desktop Combination, Regulated Switchmode AC-DC Power Supply AC Adaptor, Input Rating: 100-240V~, 50-60 Hz, IEC 60320/C6 w/ Wall Blades Option , Output Rating: 36W, 24V@1.5A, Output Configuration: 1530 mm, 18/1C + Shield Cond, UL 1185, Female Barrel 5.5 * 2.5 * 11mm with internal Spring Clip and Locking Notch or Equal, Ferrite: None, GlobTek Black, GT Cord # C0170, Pin Out: Center Positive (+V), Blades/Input Cord: R-Series 5-15P North America, Approvals: CB CB ETL ETL ETL 230V CoC Tier 2 EAC CAN ICES-3 FCC cETLus 60601-1 3rd CB IP40 LPS Class I cETLus 60950 S-Mark PSE PSE PSE CE China RoHS Level VI RoHS Ukraine VCCI WEEE CB cETLus CCC S-Mark	
	Model No. GTM96300-3624-R3A	
	Part No./Ordering No. RR9LI1500LCPIMNAR6B	Rev B

ELECTRICAL SPECIFICATIONS

A) ELECTRICAL SPECIFICATIONS:

01. Input Voltage: Specified 90-264 Vac, Nameplate rated: 100-240Vac
 - 90-264 Vac range @ 100% of rated load current
 - 85-264 Vac range @ 85% of rated load current
 - 110-370 VDC range @ 100% of rated load current
02. Input Frequency: Specified 47-63 Hz, Nameplate rated 50-60Hz
03. Output Regulation: +/- 5% measured at the output connector
04. Line Voltage Regulation: +/- 0.5% typical measured at full load
05. Green Power On Indicator LED
06. Output Ripple (Vp-p): 1% or 100 mV whichever is greater, measured at 20 MHz bandwidth with 0.1 uf ceramic capacitor in parallel with a low impedance 47 uf electrolytic capacitor connected at the end of the output connector
07. Turn-ON/OFF Overshoot: 5% maximum, 1 mS typical recovery time for 40% to 70% step load
08. Turn-ON Delay: 1 second maximum @ full load, nominal line
09. Hold-Up Time: 8 mS typical @ nominal input voltage and full load
10. Inrush Current: 30A/60A maximum cold start @ 115/230Vac input
11. Efficiency: Compliant with Efficiency Level VI and CoC Tier 2 standards
12. No Load Standby Power: <0.075 W @ 230Vac

B) PROTECTION

01. Input Protection: Input line fusing and 300Vac MOV
02. Short Circuit/ Overload: Electronically Protected unit will auto recover upon removal of fault
 - Output Current Limit: 110% to 160% of rated output current
 - (upper end of current limit range is determined by normal output power rating, not derated output power level)
03. Output Over-Voltage: 110% to 130% of nominal output voltage

C) SAFETY

01. Dielectric Withstand Voltage: 4000Vac or 5656Vdc from input to output, On Class I models, 3000Vac or 4242Vdc from input to earth
02. Earth Leakage Current: Class I models < 300uA, N/A for Class II models
03. Touch Current: Class I models < 20uA, Class II models < 75uA
04. Earth Continuity Test: < 0.1 Ohm between Earth Pin at AC input and PCB termination point (Class I models only)
05. Means of Protection: 2 x MOPP
06. Compliant Standards: See listings at end of this drawing for specifics
07. [Output Isolation Options:](#)
 - a) C8 or C18 Inlet, Class II
 - b) C6 or C14 Inlet, Class II FE, Output Isolated from Earth contact
 - c) C6 or C14 Inlet, Class I, Output negative directly attached to Earth contact

D) EMC

EN 60601-1-2, 4th edition
Emissions, per EN 55032, EN 61000-6-3, EN 61000-6-4
Conducted Emissions: Class B, FCC Part 15, Class B
Radiated Emissions: Class B, FCC Part 15, Class B
Line Frequency Harmonics EN61000-3-2, Class A
Voltage Fluctuations/Flicker EN61000-3-3

Immunity, per EN 55024, EN 61000-6-1, EN 61000-6-2
Static Discharge Immunity EN61000-4-2, 10kV Contact Discharge, 20kV air discharge
Radiated RF Immunity EN61000-4-3, 10V/m 80-1000MHz, 3V/m 1-2.7GHz, 80% 1KHz AM.
EFT/Burst Immunity EN61000-4-4, 4kV/100kHz.
Line Surge Immunity EN61000-4-5, 2kV differential, 4kV common-mode
Conducted RF Immunity EN61000-4-6, 3Vrms, 80% 1KHz AM
Power Frequency Magnetic Field Immunity EN61000-4-8, 3A/m
Voltage Dip Immunity EN61000-4-11, Criteria

E) OTHER:

01. MTBF: 1,000,000 Hours @ 40°C ambient temperature, Full Load

PROPRIETARY INFORMATION

PROPRIETARY OF GLOBTEK, INC. ANY REPRODUCTION, DISCLOSURE OR USE OF THIS DRAWING, IN WHOLE OR IN PART, IS HEREBY PROHIBITED EXCEPT AS SPECIFIED IN

WRITING BY GLOBTEK, INC.

quest /08/20/2018 1:12:23 PM

GlobTek, Inc.
www.globtek.com
186 Veterans Drive,
Northvale, NJ 07647
Tel. (201) 784-1000
Fax (201) 784-0111

Drawing Title: GTM96300-3624-R3A, Medical/ITE/Household use Power Supply, Efficiency Level: VI, Case Color/Style: GlobTek Black, Wall Plug-in+Desktop Combination, Regulated Switchmode AC-DC Power Supply AC Adaptor, Input Rating: 100-240V~, 50-60 Hz, IEC 60320/C6 w/ Wall Blades Option , Output Rating: 36W, 24V@1.5A, Output Configuration: 1530 mm, 18/1C + Shield Cond, UL 1185, Female Barrel 5.5 * 2.5 * 11mm with internal Spring Clip and Locking Notch or Equal, Ferrite: None, GlobTek Black, GT Cord # C0170, Pin Out: Center Positive (+V), Blades/Input Cord: R-Series 5-15P North America, Approvals: CB CB ETL ETL ETL 230V CoC Tier 2 EAC CAN ICES-3 FCC cETLus 60601-1 3rd CB IP40 LPS Class I cETLus 60950 S-Mark PSE PSE PSE CE China RoHS Level VI RoHS Ukraine VCCI WEEE CB cETLus CCC S-Mark

Model No. GTM96300-3624-R3A

Part No./Ordering No. RR9LI1500LCPIMNAR6B

Rev B

02. Operating Temperature:

- 20°C to 40°C ambient temperature at full load,
- 40°C to 50°C ambient temperature with derating to 80% load

03. Operating Humidity: 0% to 95% relative humidity, non-condensing

04. Storage Temperature: -30°C to 80°C

05. Operating Altitude: 5000 Meters

06. Ingress Protection: IP40 standard, IP52 available as special option

07. ROHS: Compliant with latest regulations, see approvals section below

F) ENCLOSURE

01. Housing: High impact plastic, 94V0 polycarbonate, non-vented

02. Markings: Label or Laser Printed

03. AC Input mechanical options: Desktop C6, C8, C14 or C18 IEC Inlet.

Hybrid option (Desktop or Changeable Blade Wall Plug-in) Class I or Class II input

G) SPECIAL OPTIONS

01. Cost reduction, removal of LED

02. Custom Cordsets, various cordage types, and connector types

03. Custom Markings

04. Short term Output Surge Capability

05. Reduced Leakage Current versions

06. Tightened output voltage tolerance

07. Reduced output ripple level

08. Reduced output power rating marking

09. High Rel PCB laminate with Plated through Holes for IPC610 Class 2 Compliance

10. Special Housing Colors and Cordset Colors

11. Quasi Constant Current Output, for Lead-Acid Battery Charger Applications

GlobTek, Inc.
 www.globtek.com
 186 Veterans Drive,
 Northvale, NJ 07647
 Tel. (201) 784-1000
 Fax (201) 784-0111

Drawing Title: GTM96300-3624-R3A, Medical/ITE/Household use Power Supply, Efficiency Level: VI, Case Color/Style: GlobTek Black, Wall Plug-in+Desktop Combination, Regulated Switchmode AC-DC Power Supply AC Adaptor, Input Rating: 100-240V~, 50-60 Hz, IEC 60320/C6 w/ Wall Blades Option , Output Rating: 36W, 24V@1.5A, Output Configuration: 1530 mm, 18/1C + Shield Cond, UL 1185, Female Barrel 5.5 * 2.5 * 11mm with internal Spring Clip and Locking Notch or Equal, Ferrite: None, GlobTek Black, GT Cord # C0170, Pin Out: Center Positive (+V), Blades/Input Cord: R-Series 5-15P North America, Approvals: CB CB ETL ETL ETL 230V CoC Tier 2 EAC CAN ICES-3 FCC cETLus 60601-1 3rd CB IP40 LPS Class I cETLus 60950 S-Mark PSE PSE PSE CE China RoHS Level VI RoHS Ukraine VCCI WEEE CB cETLus CCC S-Mark

Model No. GTM96300-3624-R3A

Part No./Ordering No. RR9LI1500LCPIMNAR6B

Rev B

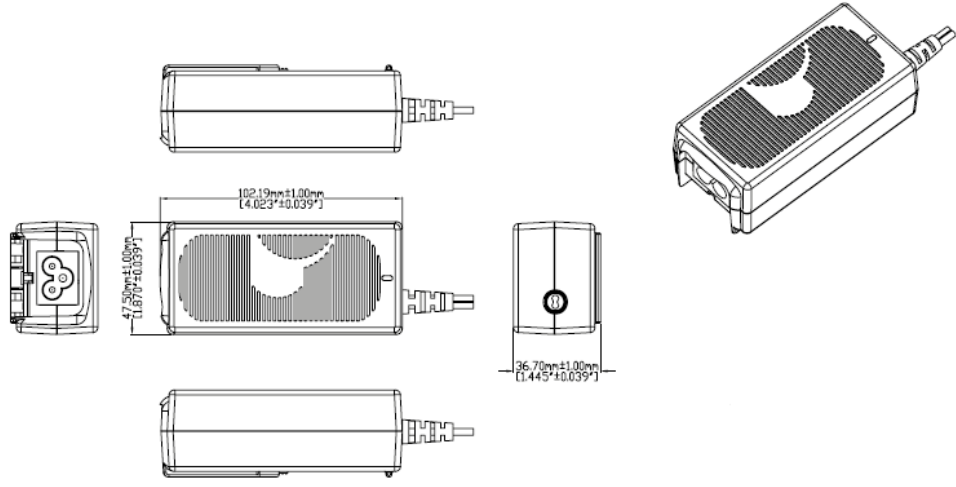

DERATING CURVE

TYPICAL EXTERNAL POWER SUPPLY DERATING CURVE

(FOR EFFICIENCY LEVEL V AND EFFICIENCY LEVEL VI PRODUCTS)

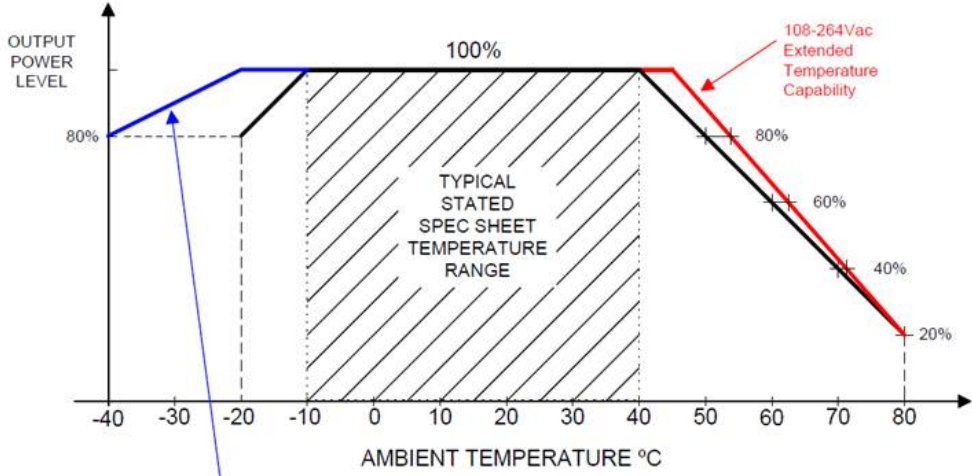

Blue Line represents special/optional Low Temperature, High Performance Construction

GlobTek, Inc.
 www.globtek.com
 186 Veterans Drive,
 Northvale, NJ 07647
 Tel. (201) 784-1000
 Fax (201) 784-0111

Drawing Title: GTM96300-3624-R3A, Medical/ITE/Household use Power Supply, Efficiency Level: VI, Case Color/Style: GlobTek Black, Wall Plug-in+Desktop Combination, Regulated Switchmode AC-DC Power Supply AC Adaptor, Input Rating: 100-240V~, 50-60 Hz, IEC 60320/C6 w/ Wall Blades Option , Output Rating: 36W, 24V@1.5A, Output Configuration: 1530 mm, 18/1C + Shield Cond, UL 1185, Female Barrel 5.5 * 2.5 * 11mm with internal Spring Clip and Locking Notch or Equal, Ferrite: None, GlobTek Black, GT Cord # C0170, Pin Out: Center Positive (+V), Blades/Input Cord: R-Series 5-15P North America, Approvals: CB CB ETL ETL ETL 230V CoC Tier 2 EAC CAN ICES-3 FCC cETLus 60601-1 3rd CB IP40 LPS Class I cETLus 60950 S-Mark PSE PSE PSE CE China RoHS Level VI RoHS Ukraine VCCI WEEE CB cETLus CCC S-Mark

Model No. GTM96300-3624-R3A

Part No./Ordering No. RR9LI1500LCPIMNAR6B

Rev B

INPUT CONFIGURATION

Grounding Configuration:

Blades/Cord Included: R-NA-3(R):

Blades/Cord Installed: R-NA-3(R):

IEC 60320/C6 AC Inlet Connector, Class I, Earth Ground (aka "Mickey Mouse")

[Blade Insertion Instructions](#)

[R-Blade Style Instruction Video](#)

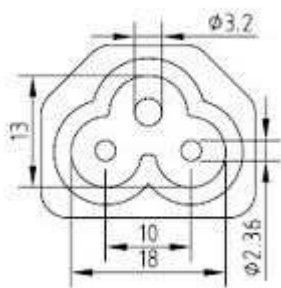

Mates with IEC 60320/C5 Plug

This series of Interchangeable Blade products may be used with Proprietary Interchangeable Blades as described below or with standard international power cords.

Optional INPUT BLADES: R-Socket: below are available blades configurations which are "not included" (unless stated above); may be purchased separately, packaged with power supply, or as a separate "R-KIT" if specified

1. Class I model NEMA 5-15P, Class I AC power plug with 2 blades & ground pin, R-NA-3(R)
2. Australian AS 3112 configuration: SAA 3 pins Class I, R-SAA-3(R)
3. UK BS 1363 configuration: UK 3 pins (Ground) Class I, R-UK-3(R)
4. European CEE 7/16 configuration: Europlug 3 PINS, Class I, R-EU-3(R)
5. Desktop Insert

Kits

05. R-3-KIT: 1,2,3,4 above

06. R-3-KIT-INTL: 2,3,4 above

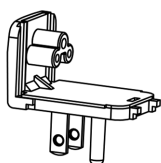

UL 3P

P/N: R-NA-3(R)
 NORTH AMERICA
 JAPAN

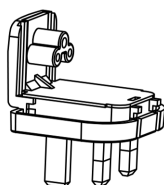

UK 3P

P/N: R-UK-3(R)
 UNITED KINGDOM
 HONG KONG
 SINGAPORE

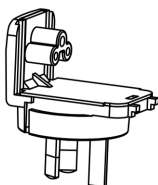

AUS 3P

P/N: R-SAA-3(R)
 AUSTRALIA

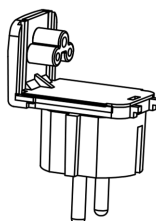

EU 3P

P/N: R-EU-3(R)
 EUROPE
 SOUTH AMERICA

GlobTek, Inc.
www.globtek.com
186 Veterans Drive,
Northvale, NJ 07647
Tel. (201) 784-1000
Fax (201) 784-0111

Drawing Title: GTM96300-3624-R3A, Medical/ITE/Household use Power Supply, Efficiency Level: VI, Case Color/Style: GlobTek Black, Wall Plug-in+Desktop Combination, Regulated Switchmode AC-DC Power Supply AC Adaptor, Input Rating: 100-240V~, 50-60 Hz, IEC 60320/C6 w/ Wall Blades Option , Output Rating: 36W, 24V@1.5A, Output Configuration: 1530 mm, 18/1C + Shield Cond, UL 1185, Female Barrel 5.5 * 2.5 * 11mm with internal Spring Clip and Locking Notch or Equal, Ferrite: None, GlobTek Black, GT Cord # C0170, Pin Out: Center Positive (+V), Blades/Input Cord: R-Series 5-15P North America, Approvals: CB CB ETL ETL ETL 230V CoC Tier 2 EAC CAN ICES-3 FCC cETLus 60601-1 3rd CB IP40 LPS Class I cETLus 60950 S-Mark PSE PSE PSE CE China RoHS Level VI RoHS Ukraine VCCI WEEE CB cETLus CCC S-Mark

Model No. GTM96300-3624-R3A

Part No./Ordering No. RR9LI1500LCPIMNAR6B

Rev B

Below are standard cordsets which are "not included" (unless stated above); these can be purchased separately or package with the power supply. Contact your Sales Engineer if the style required is not shown below. Many more available in different lengths, colors or cable material.

[Standard International IEC 320/C Cordsets](#)

3021066F712(R)	N. American	NEMA 5-15P	IEC 320/C5	1880	6
1191068F0712(R)	N. American	NEMA 5-15P Hospital	IEC 320/C5	2459	8
2064262M0712(R)	Australian	AS3112 / 3 PRONG	IEC 320/C5	2050	7
204B4262M0712(R)	Brazil	BRAZILIAN; WS-002	IEC 320/C5	2050	7
6023592M5712(R)	China	CCC GR2099	IEC 320/C5	2500	8
23144262M0712(R)	Europe	CEE 7/7	IEC 320/C5	2050	7
2084262M0712(R)	India/S.Africa	India/S.Africa	IEC 320/C5	2050	7
23024262M0712(R)	Italy	CEI 23-16/VII	IEC 320/C5	2050	7
3003316F0712(R)	Japan	JIS 8303 / 3 PINS	IEC 320/C5	1830	6
23214262M0712(R)	Switzerland	SEV 1011 (EL 203)	IEC 320/C5	2050	7
6104262M0712(R)	UK	BS1363	IEC 320/C5	2050	7

GlobTek, Inc.
 www.globtek.com
 186 Veterans Drive,
 Northvale, NJ 07647
 Tel. (201) 784-1000
 Fax (201) 784-0111

Drawing Title: GTM96300-3624-R3A, Medical/ITE/Household use Power Supply, Efficiency Level: VI, Case Color/Style: GlobTek Black, Wall Plug-in+Desktop Combination, Regulated Switchmode AC-DC Power Supply AC Adaptor, Input Rating: 100-240V~, 50-60 Hz, IEC 60320/C6 w/ Wall Blades Option , Output Rating: 36W, 24V@1.5A, Output Configuration: 1530 mm, 18/1C + Shield Cond, UL 1185, Female Barrel 5.5 * 2.5 * 11mm with internal Spring Clip and Locking Notch or Equal, Ferrite: None, GlobTek Black, GT Cord # C0170, Pin Out: Center Positive (+V), Blades/Input Cord: R-Series 5-15P North America, Approvals: CB CB ETL ETL ETL 230V CoC Tier 2 EAC CAN ICES-3 FCC cETLus 60601-1 3rd CB IP40 LPS Class I cETLus 60950 S-Mark PSE PSE PSE CE China RoHS Level VI RoHS Ukraine VCCI WEEE CB cETLus CCC S-Mark

Model No. GTM96300-3624-R3A

Part No./Ordering No. RR9LI1500LCPIMNAR6B

Rev B

OUTPUT CORD AND CONNECTOR: LCL/C0170

ACTUAL CONNECTORS, OVERMOLDS, FERRITES MAY VARY SLIGHTLY FROM THE PICTURE BELOW

CABLE TYPE	UL 1185
CABLE LENGTH (mm)	1530
CABLE TOLERANCE (mm)	+150-0
WIRE GAUGE (AWG)	18
CONDUCTORS	1C + Shield
HANK DIMENSION (mm)	80 ± 10
CABLE / CONNECTOR OVERMOLD COLOR	GlobTek Black
FERRITE TYPE / DIMENSION	None
FERRITE # OF TURNS (Definition)	N/A
FERRITE DIMENSION FROM STRAIN RELIEF	N/A
FERRITE DIMENSION FROM PLUG	N/A
PLUG TYPE	Female Barrel 5.5 * 2.5 * 11mm with internal Spring Clip and Locking Notch or Equal
OVER MOLD ORIENTATION	Straight
CONNECTOR PIN OUT:	Center Positive (+V)
ADDITIONAL REQUIREMENTS	

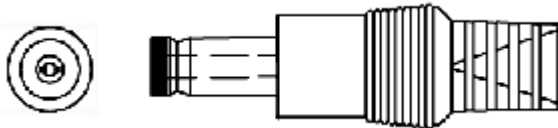

ADDITIONAL OUTPUT PLUG OPTIONS ARE AVAILABLE AT <http://www.globtek.com/connectors/>
 STANDARD PLUGS AND CONNECTORS CAN BE SEEN ONLINE AT <http://www.globtek.com/connectors/>

GlobTek, Inc.
 www.globtek.com
 186 Veterans Drive,
 Northvale, NJ 07647
 Tel. (201) 784-1000
 Fax (201) 784-0111

Drawing Title: GTM96300-3624-R3A, Medical/ITE/Household use Power Supply, Efficiency Level: VI, Case Color/Style: GlobTek Black, Wall Plug-in+Desktop Combination, Regulated Switchmode AC-DC Power Supply AC Adaptor, Input Rating: 100-240V~, 50-60 Hz, IEC 60320/C6 w/ Wall Blades Option , Output Rating: 36W, 24V@1.5A, Output Configuration: 1530 mm, 18/1C + Shield Cond, UL 1185, Female Barrel 5.5 * 2.5 * 11mm with internal Spring Clip and Locking Notch or Equal, Ferrite: None, GlobTek Black, GT Cord # C0170, Pin Out: Center Positive (+V), Blades/Input Cord: R-Series 5-15P North America, Approvals: CB CB ETL ETL ETL 230V CoC Tier 2 EAC CAN ICES-3 FCC cETLus 60601-1 3rd CB IP40 LPS Class I cETLus 60950 S-Mark PSE PSE PSE CE China RoHS Level VI RoHS Ukraine VCCI WEEE CB cETLus CCC S-Mark

Model No. GTM96300-3624-R3A

Part No./Ordering No. RR9LI1500LCPIMNAR6B

Rev B

LABEL:L-1186

LABEL P/N: Standard GT
 MATERIAL: Flat Thermal Transfer, Imprintable, Polyester Label and/or Pad Printed and/or Molded, and/or Laser Engraved in the case
 BACKGROUND COLOR: Black if housing is Black, White or Silver if housing is White or Gray.
 TEXT COLOR: White or Silver if label is Black Background for Black housing. Black if label is White or Silver background and Housing is White or Gray
 LABEL WIDTH (mm): 37.5
 LABEL HEIGHT (mm): 33.5

Below is the minimum information which will appear on the label. NOTE: in the logo area additional/actual positioning of symbols and text is subjected to change as per agency updates/requirements or additional model approvals become available. Regulatory certifications/label markings may be in logo area on the label or molded into the case housing outside the label area. Information will be shown via label and/or pad printed and/or molded and/or laser engraved in the case. * Date code markings at GlobTek option.



DATE CODE A *:

DATE CODE LABEL



Series NO. Week Year
 Class NO. for production

or

DATE CODE B *:

WWYY
 WW = WEEK
 YY = YEAR

A=Medical/ITE/Household use Power Supply
 B=P/N: (料号) RR9LI1500LCPIMNAR6B
 C=Model (型号) GTM96300-3624-R3A
 D=Input (输入) 100-240V~, 50-60 Hz, 1.0A
 E=Output (输出) 24 V 1.5 A ,36.0W

- AGENCY ONLINE DOCUMENTS <http://www.globtek.info/certs/GTM96300-TZ/>
- CE EC-Declaration for Medical http://www.globtek.com/pdf/ec_declaration/a0Oa000000Mm3T6EAJ
- CE EC-Declaration for Industrial/Commercial/ITE http://www.globtek.com/pdf/ec_declaration/a0Oa000000Mm3T6EAJ
- RoHS/RoHS2 Declaration http://www.globtek.com/pdf/rohs_cert/01ta0000007dRHJAA2
- REACH Declaration http://www.globtek.com/pdf/iso_certificates/REACH.pdf

GlobTek, Inc.
www.globtek.com
186 Veterans Drive,
Northvale, NJ 07647
Tel. (201) 784-1000
Fax (201) 784-0111

Drawing Title: GTM96300-3624-R3A, Medical/ITE/Household use Power Supply, Efficiency Level: VI, Case Color/Style: GlobTek Black, Wall Plug-in+Desktop Combination, Regulated Switchmode AC-DC Power Supply AC Adaptor, Input Rating: 100-240V~, 50-60 Hz, IEC 60320/C6 w/ Wall Blades Option , Output Rating: 36W, 24V@1.5A, Output Configuration: 1530 mm, 18/1C + Shield Cond, UL 1185, Female Barrel 5.5 * 2.5 * 11mm with internal Spring Clip and Locking Notch or Equal, Ferrite: None, GlobTek Black, GT Cord # C0170, Pin Out: Center Positive (+V), Blades/Input Cord: R-Series 5-15P North America, Approvals: CB CB ETL ETL ETL 230V CoC Tier 2 EAC CAN ICES-3 FCC cETLus 60601-1 3rd CB IP40 LPS Class I cETLus 60950 S-Mark PSE PSE PSE CE China RoHS Level VI RoHS Ukraine VCCI WEEE CB cETLus CCC S-Mark

Model No. GTM96300-3624-R3A

Part No./Ordering No. RR9LI1500LCPIMNAR6B

Rev B

Conflict Minerals Declaration

<http://www.globtek.com/pdf/conflict-minerals.pdf>

IPXY rating is based on 3rd party testing and customers should check suitability and test system level IPXY rating before ordering.

Regulatory Certifications/Label Markings

LATEST PRODUCT/MODEL CERTIFICATIONS: <http://en.globtek.com/datasheet/id/a0Oa000000Mm3T6>

AGENCY ONLINE DOCUMENTS: <http://www.globtek.info/certs/GTM96300-TZ/>

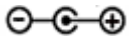

Center Positive (+V)

GlobTek, Inc.
www.globtek.com
186 Veterans Drive,
Northvale, NJ 07647
Tel. (201) 784-1000
Fax (201) 784-0111

Drawing Title: GTM96300-3624-R3A, Medical/ITE/Household use Power Supply, Efficiency Level: VI, Case Color/Style: GlobTek Black, Wall Plug-in+Desktop Combination, Regulated Switchmode AC-DC Power Supply AC Adaptor, Input Rating: 100-240V~, 50-60 Hz, IEC 60320/C6 w/ Wall Blades Option , Output Rating: 36W, 24V@1.5A, Output Configuration: 1530 mm, 18/1C + Shield Cond, UL 1185, Female Barrel 5.5 * 2.5 * 11mm with internal Spring Clip and Locking Notch or Equal, Ferrite: None, GlobTek Black, GT Cord # C0170, Pin Out: Center Positive (+V), Blades/Input Cord: R-Series 5-15P North America, Approvals: CB CB ETL ETL ETL 230V CoC Tier 2 EAC CAN ICES-3 FCC cETLus 60601-1 3rd CB IP40 LPS Class I cETLus 60950 S-Mark PSE PSE PSE CE China RoHS Level VI RoHS Ukraine VCCI WEEE CB cETLus CCC S-Mark

Model No. GTM96300-3624-R3A

Part No./Ordering No. RR9LI1500LCPIMNAR6B

Rev B

PACKAGING

Packing Spec P/N: Standard WPI, Individually
Box

Box Qty: 48

Gift Box Size (mm): Egg Crate

Gift Box Color: White

Master Carton Size (mm): 442*330*275

Master GW (Kg): 15.2 kg

BLADES INCLUDED: R-NA-3(R):

BLADE/CORD INSTALLED: R-NA-3(R):

If specific packaging is required, this section must specify all requirements and note "no exceptions". If this section does not specify packaging, it is subject to change without notice at GlobTek's discretion

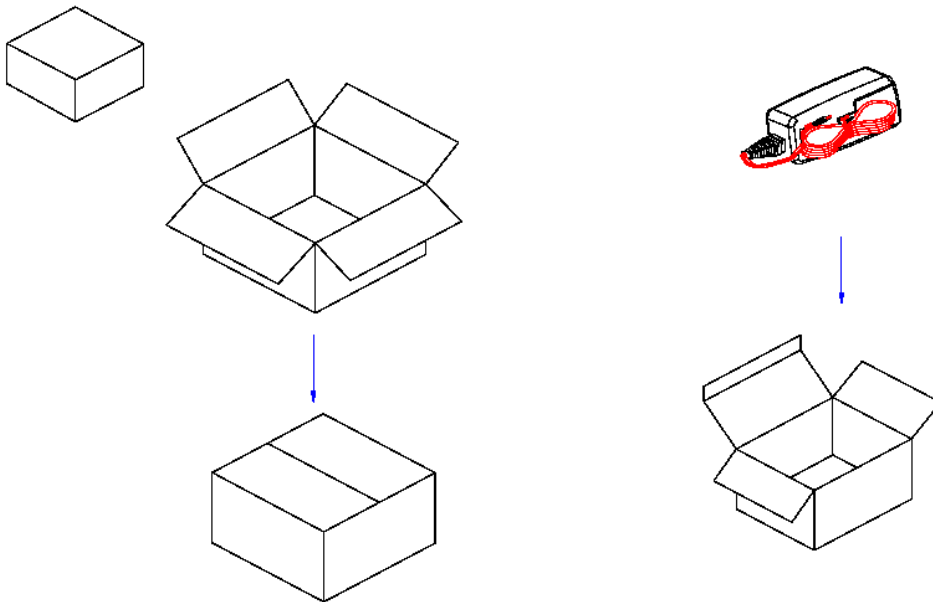

GlobTek, Inc.
www.globtek.com
186 Veterans Drive,
Northvale, NJ 07647
Tel. (201) 784-1000
Fax (201) 784-0111

Drawing Title: GTM96300-3624-R3A, Medical/ITE/Household use Power Supply, Efficiency Level: VI, Case Color/Style: GlobTek Black, Wall Plug-in+Desktop Combination, Regulated Switchmode AC-DC Power Supply AC Adaptor, Input Rating: 100-240V~, 50-60 Hz, IEC 60320/C6 w/ Wall Blades Option , Output Rating: 36W, 24V@1.5A, Output Configuration: 1530 mm, 18/1C + Shield Cond, UL 1185, Female Barrel 5.5 * 2.5 * 11mm with internal Spring Clip and Locking Notch or Equal, Ferrite: None, GlobTek Black, GT Cord # C0170, Pin Out: Center Positive (+V), Blades/Input Cord: R-Series 5-15P North America, Approvals: CB CB ETL ETL ETL 230V CoC Tier 2 EAC CAN ICES-3 FCC cETLus 60601-1 3rd CB IP40 LPS Class I cETLus 60950 S-Mark PSE PSE PSE CE China RoHS Level VI RoHS Ukraine VCCI WEEE CB cETLus CCC S-Mark

Model No. GTM96300-3624-R3A

Part No./Ordering No. RR9LI1500LCPIMNAR6B

Rev B

INSTRUCTION SHEET

N/A