



Chipsmall Limited consists of a professional team with an average of over 10 year of expertise in the distribution of electronic components. Based in Hongkong, we have already established firm and mutual-benefit business relationships with customers from,Europe,America and south Asia,supplying obsolete and hard-to-find components to meet their specific needs.

With the principle of "Quality Parts,Customers Priority,Honest Operation,and Considerate Service",our business mainly focus on the distribution of electronic components. Line cards we deal with include Microchip,ALPS,ROHM,Xilinx,Pulse,ON,Everlight and Freescale. Main products comprise IC,Modules,Potentiometer,IC Socket,Relay,Connector.Our parts cover such applications as commercial,industrial, and automotives areas.

We are looking forward to setting up business relationship with you and hope to provide you with the best service and solution. Let us make a better world for our industry!



## Contact us

Tel: +86-755-8981 8866 Fax: +86-755-8427 6832

Email & Skype: info@chipsmall.com Web: www.chipsmall.com

Address: A1208, Overseas Decoration Building, #122 Zhenhua RD., Futian, Shenzhen, China



# RSAL SERIES

## Compact Multipurpose Type Compatible with High-Voltage Pulse



### FEATURES

- Amorphous core is used as the common mode coil core for the RSEL series, which helps prevent device errors.
- Wire type and lug terminal type are available with the same shape.
- Optional low-leakage characteristic type is also available.
- Compliant with RoHS directives.

### SAFETY STANDARDS

UL1283	File No. E62388
CSA C22.2 No.8	File No. 208777
EN60939	Licence Ref. No. SE/07115-1

### PRODUCT IDENTIFICATION

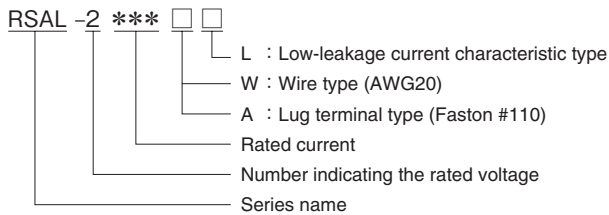

### CIRCUIT DIAGRAMS

RSAL-2 \*\*\* W  
RSAL-2 \*\*\* A

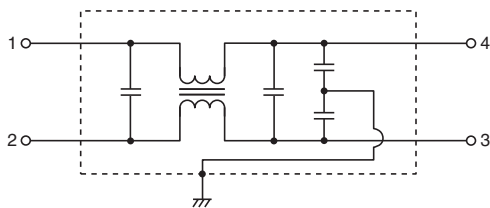

RSAL-2 \*\*\* WL  
RSAL-2 \*\*\* AL

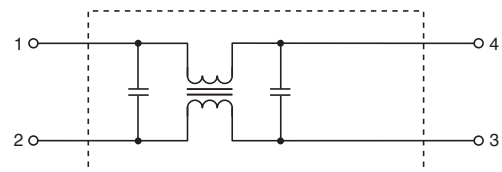

• Faston® is a registered trademark of Tyco Electronics AMP Corp. Incorporated.

• Conformity to RoHS Directive: This means that, in conformity with EU Directive 2002/95/EC, lead, cadmium, mercury, hexavalent chromium, and specific bromine-based flame retardants, PBB and PBDE, have not been used, except for exempted applications.

• All specifications are subject to change without notice.

## ELECTRICAL CHARACTERISTICS

Part No.	Rated voltage (AC/DC)	Rated current (AC/DC)	Withstand voltage	Insulation resistance	Leakage current	Operating temperature range	With derating over	DC resistance (mΩ)	Attenuation frequency range (MHz)		Weight (g)
									Common mode	Differential mode	
									at 25dB	at 25dB	
RSAL-20R5W	250V	0.5A	AC.2500V 60s [Between line to ground]	100MΩmin. [DC.500V/ 1min]	1.0mA max. [250V/60Hz]	-25 to +85°C	55°C	700 max.	0.3 to 8	0.4 to 30	58
RSAL-2001W		1A						600 max.	0.3 to 8	0.5 to 30	58
RSAL-2002W		2A						250 max.	0.5 to 8	0.7 to 30	61
RSAL-2003W		3A						150 max.	1 to 7	0.8 to 30	61
RSAL-2006W		6A						80 max.	3 to 7	1 to 30	61
RSAL-20R5A		0.5A						700 max.	0.3 to 8	0.4 to 30	43
RSAL-2001A		1A						600 max.	0.3 to 8	0.5 to 30	43
RSAL-2002A		2A						250 max.	0.5 to 8	0.7 to 30	46
RSAL-2003A		3A						150 max.	1 to 7	0.8 to 30	46
RSAL-2006A		6A						80 max.	3 to 7	1 to 30	46

Part No.	Rated voltage (AC/DC)	Rated current (AC/DC)	Withstand voltage	Insulation resistance	Leakage current	Operating temperature range	With derating over	DC resistance (mΩ)	Attenuation frequency range (MHz)		Weight (g)
									Common mode	Differential mode	
									at 15dB	at 25dB	
RSAL-20R5WL	250V	0.5A	AC.2500V 60s [Between line to ground]	100MΩmin. [DC.500V/ 1min]	10 μ A max. [250V/60Hz]	-25 to +85°C	55°C	700 max.	0.1 to 5	0.4 to 30	56
RSAL-2001WL		1A						600 max.	0.1 to 5	0.5 to 30	56
RSAL-2002WL		2A						250 max.	0.1 to 5	0.7 to 30	59
RSAL-2003WL		3A						150 max.	0.2 to 5	0.8 to 30	59
RSAL-2006WL		6A						80 max.	1 to 30	1 to 30	59
RSAL-20R5AL		0.5A						700 max.	0.1 to 5	0.4 to 30	41
RSAL-2001AL		1A						600 max.	0.1 to 5	0.5 to 30	41
RSAL-2002AL		2A						250 max.	0.1 to 5	0.7 to 30	44
RSAL-2003AL		3A						150 max.	0.2 to 5	0.8 to 30	44
RSAL-2006AL		6A						80 max.	1 to 30	1 to 30	44

## DERATINGS

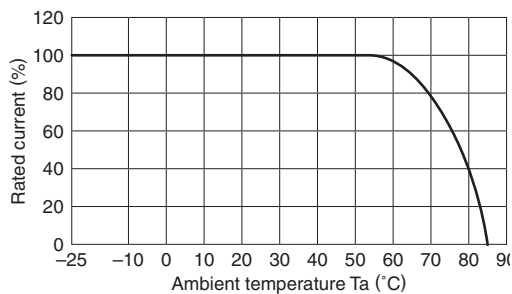

■ SHAPES AND DIMENSIONS

RSAL-20R5/2001/2002/2003/2006W(L)

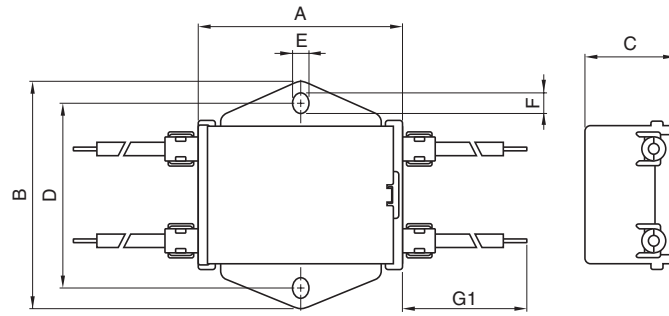

RSAL-20R5/2001/2002/2003/2006A(L)

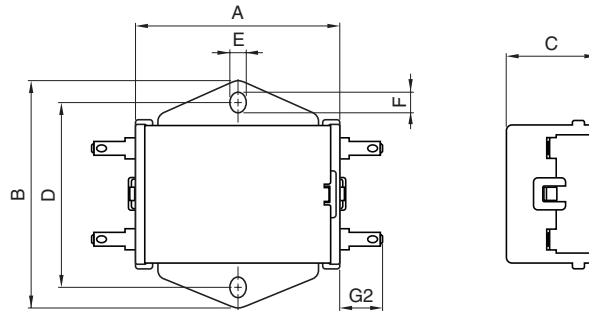

Dimensions in mm

Part No.	A	B	C	D	E	F	G1	G2
RSAL-20R5W(L)	45	50	20	40	3.5	4.5	300	-
RSAL-2001W(L)								
RSAL-2002W(L)								
RSAL-2003W(L)								
RSAL-2006W(L)								
RSAL-20R5A(L)	45	50	20	40	3.5	4.5	-	9
RSAL-2001A(L)								
RSAL-2002A(L)								
RSAL-2003A(L)								
RSAL-2006A(L)								

**ATTENUATION vs. FREQUENCY CHARACTERISTICS**

RSAL-20R5W/A

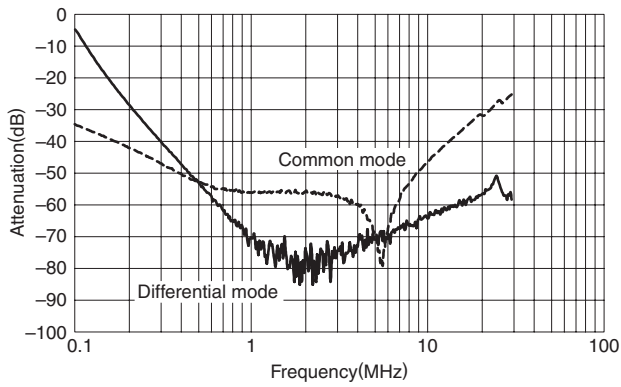

RSAL-2001W/A

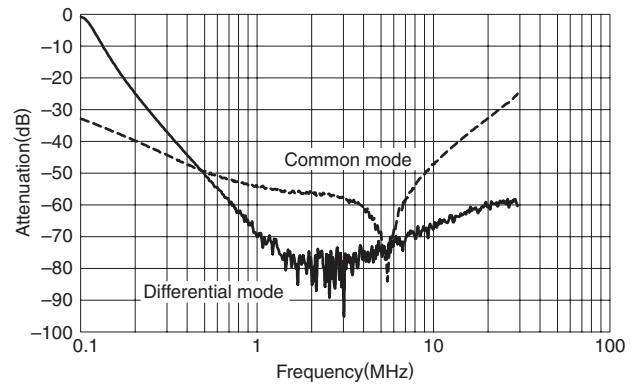

RSAL-2002W/A

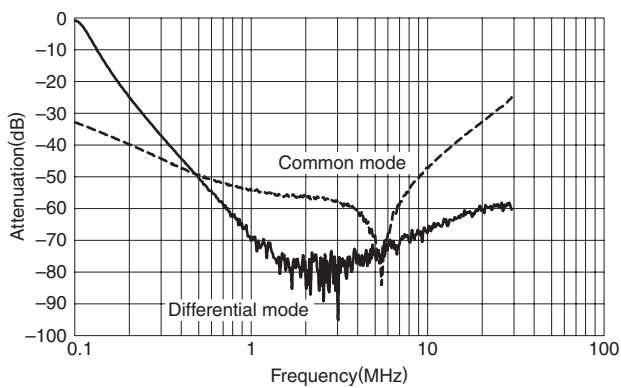

RSAL-2003W/A

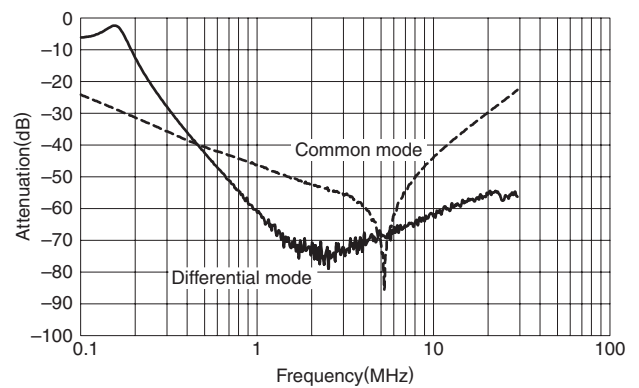

RSAL-2006W/A

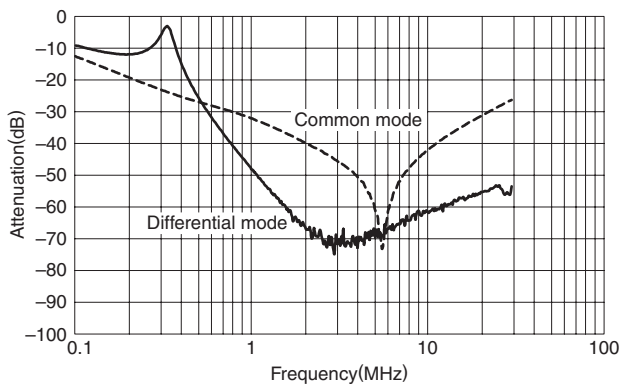

RSAL-20R5WL/AL

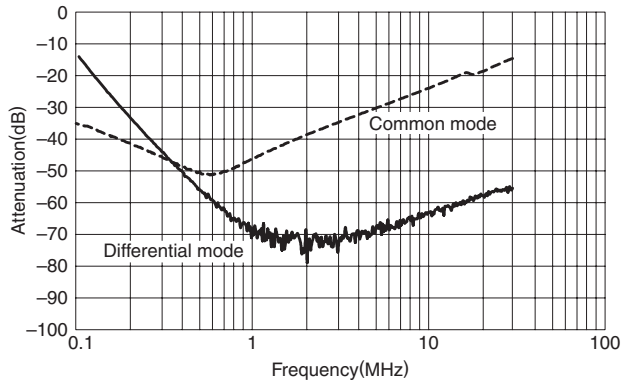

RSAL-2001WL/AL

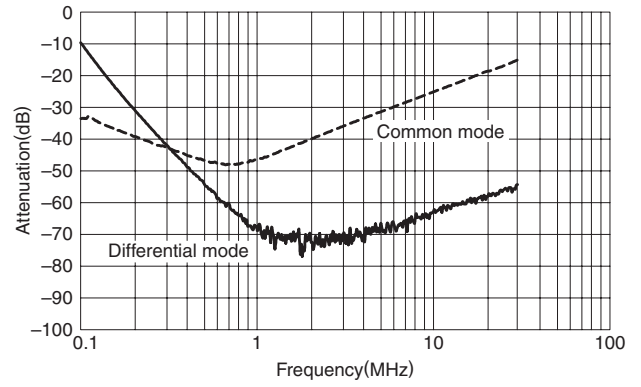

RSAL-2002WL/AL

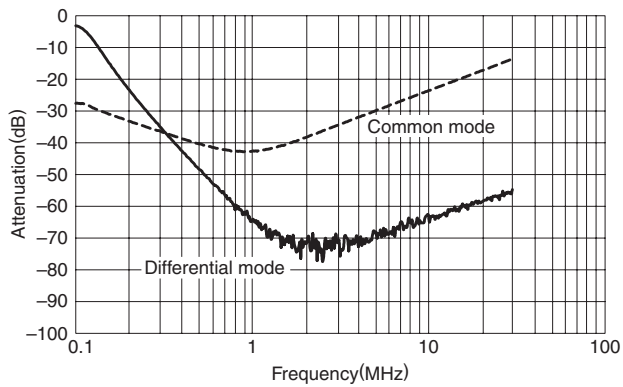

RSAL-2003WL/AL

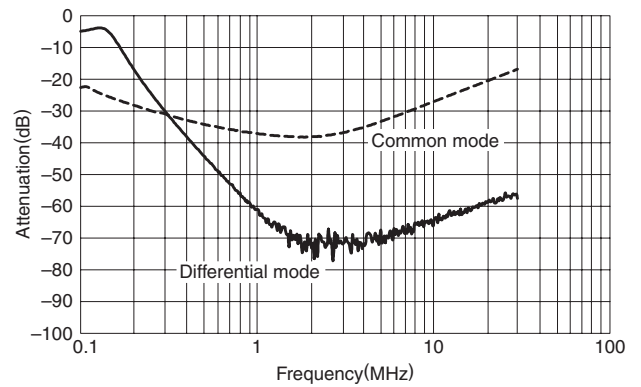

RSAL-2006WL/AL

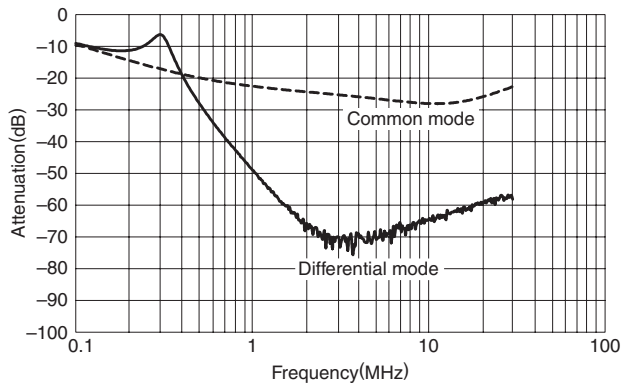

**PULSE ATTENUATION CHARACTERISTICS**

RSAL-20R5W/A

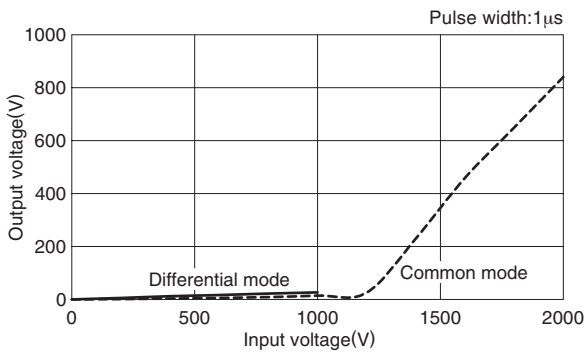

RSAL-2001W/A

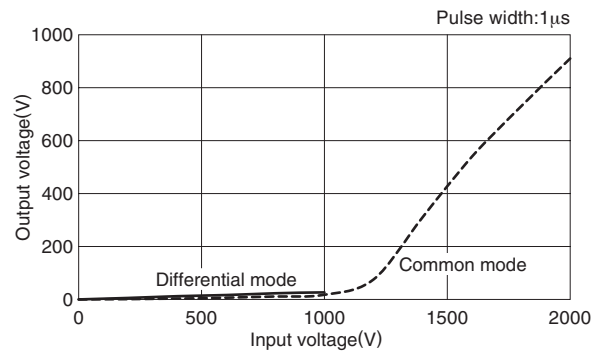

RSAL-2002W/A

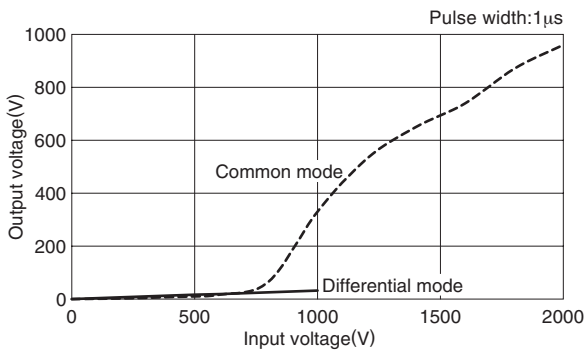

RSAL-2003W/A

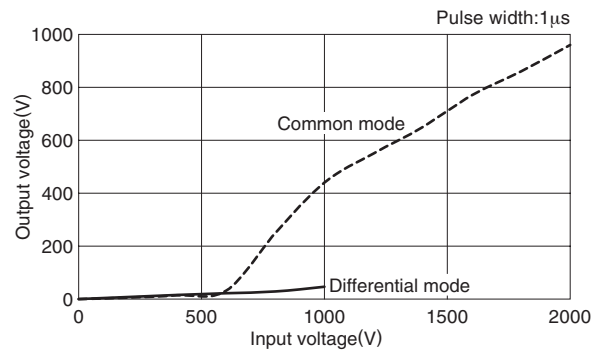

RSAL-2006W/A

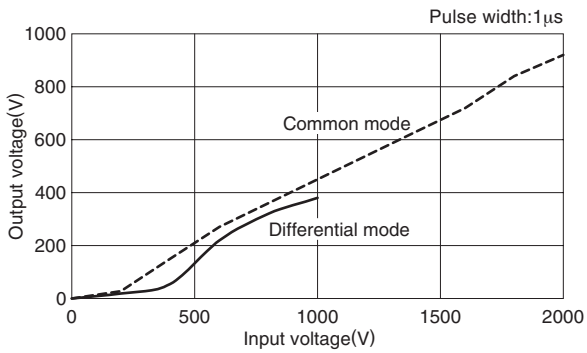

RSAL-20R5WL/AL

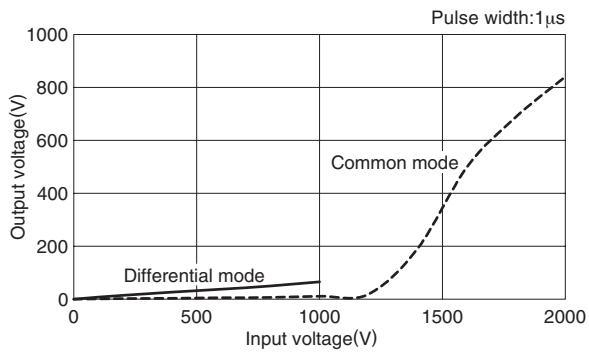

RSAL-2001WL/AL

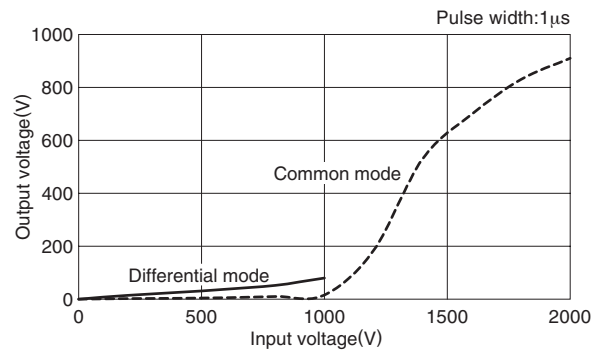

RSAL-2002WL/AL

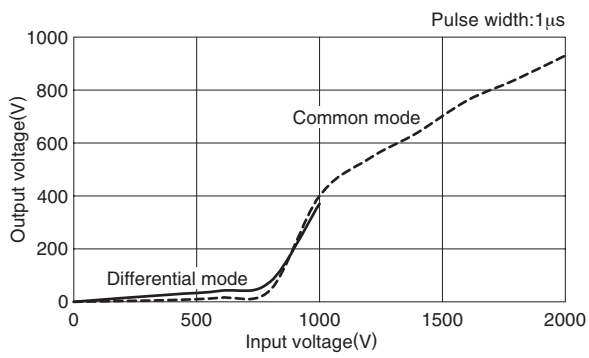

RSAL-2003WL/AL

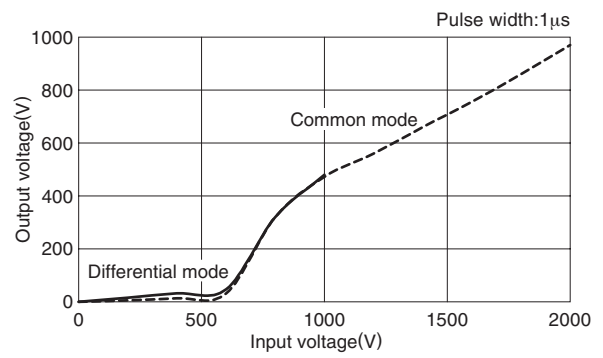

RSAL-2006WL/AL

